

INTEGRATOR PACKAGE DATA SHEET

CONFIGURABLE CO₂ LASER PROCESSING SUB-SYSTEM FOR FASTER, EASIER OEM INTEGRATION

Novanta combined its industry leading Synrad and Cambridge Technology product brands into configurable laser processing packages to help OEMs and system integrators get up and running faster and easier. Save precious integration time and resources with robust laser processing sub-system packages utilizing industry leading components.



FASTER MARKING & CODING

Take your laser marking and coding to the next level with up to 400 W of CO₂ laser power combined with a new, hybrid analog/digital 2-axis scan head. The advanced controller/software features deliver crisp, clear marks and codes while optimizing throughput speed.



PRECISE CUTTING, SCORING, & PERFORATING

Designed for precision cutting of thinner materials with stable power coupled with precise beam positioning and ultra-low drift. Advanced controller/software features ensure smooth cuts around curves and sharp corners and avoid over-processed burn marks.



ABLATION & ENGRAVING

Remove insulating layers on wires, apply graphics, text, and codes with pinpoint accuracy. Lightweight, low drift mirrors and small laser spot deliver high detail levels and consistent results.

KEY FEATURES & ADVANTAGES

- **Save Integration Time and Resources** - pre-aligned and calibrated sub-system includes CO₂ laser source, 2-axis scan head, controller, software, accessories, and mounting hardware. Eliminates component compatibility issues, integration challenges, and run-around technical support.
- **Configured to Meet Your Needs** – multiple options for CO₂ laser power and wavelength, 2-axis scan heads, cooling, and specialized application tuning with guided selection advice from Novanta Application Engineers.
- **High Performance & Reliability** – designed and built with industry leading components from Novanta's Cambridge Technology and Synrad brands. Each component has a long history of proven in-field performance.
- **Fast Uptime** – powerful ScanMaster™ controller and software package is easy to use and includes modern features that improve scanning accuracy and processing throughput. Harmonized shipping ensures quick arrival of all parts and components with easy out-of-the-box assembly and operation.
- **More System Configuration Options** - maintains more than 15 million vector moves with more than 7.5GB onboard storage space for standalone operations and remote administration, eliminating the need for an operating PC.
- **Sole Source** – single point-of-contact for purchasing, shipping, service, and technical support

INTEGRATOR PACKAGE INCLUSIONS

 Invisible Laser Radiation
Avoid eye or skin exposure to direct or scattered radiation
Class 4 Laser Product.

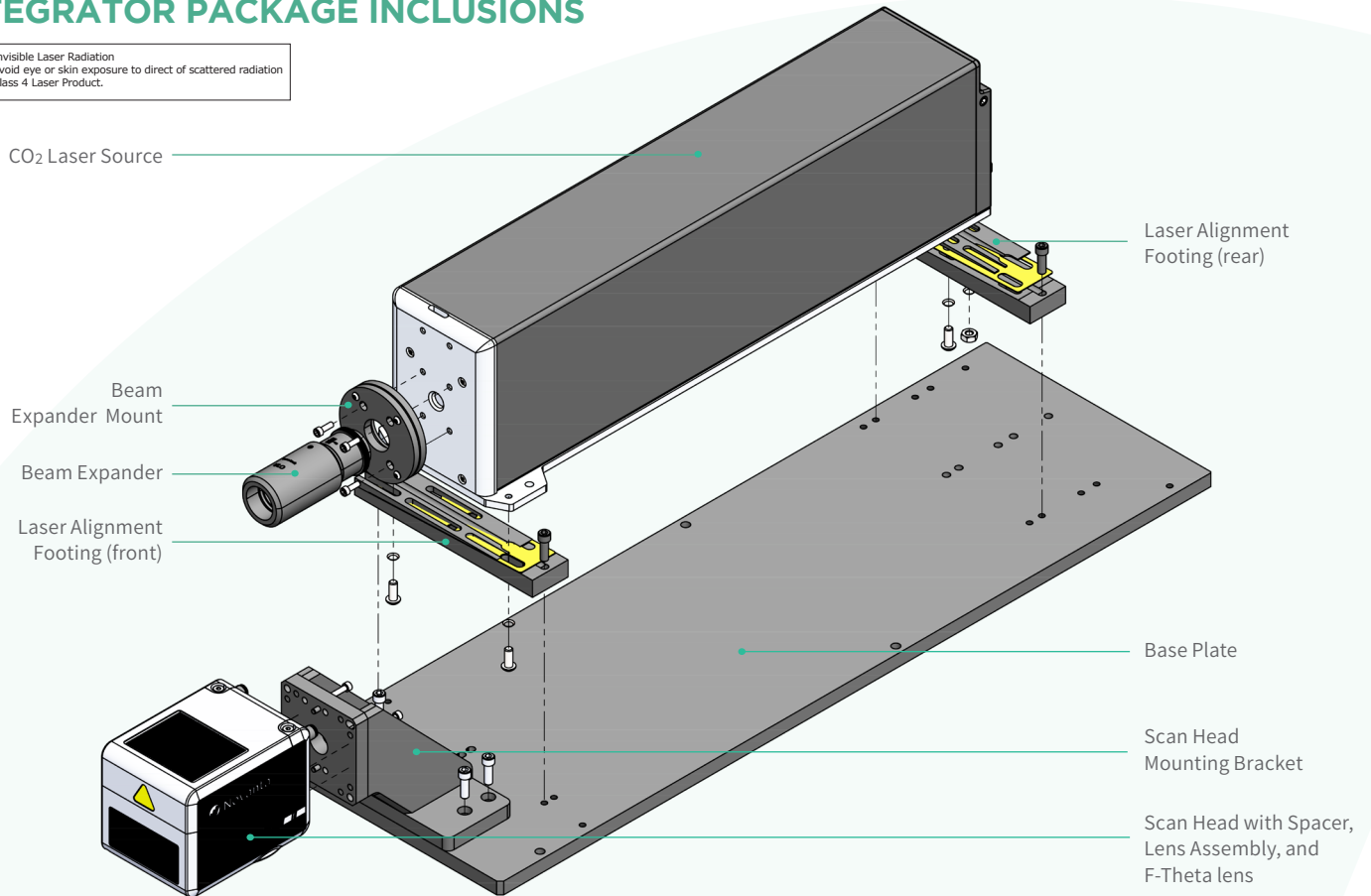

Also Included

- Connector Cables
- Assembly Instructions
- Power Supplies (laser & scan head)
- Tuning & Calibration

Not Included

- Chiller
- Coolant Hoses

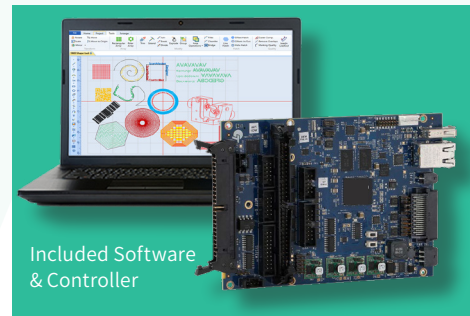

KEY COMPONENT OPTIONS

CO₂ Laser Sources

Family	Power (W)	Wavelength (µm)	Cooling
48 Series	8 - 10	9.3, 10.6	Air, Water
v Series	30	9.3, 10.2, 10.6	Air, Water, Fan
vi Series*	30	9.3, 10.2, 10.6	Air
ti Series	60, 80, 100	9.3, 10.2, 10.6	Air, Water, Fan
f Series	200	10.2, 10.6	Water
i Series	400	10.2, 10.6	Water
p Series*	100 - 150 average / 300 - 600 peak	9.3, 10.2, 10.6	Water
	250 average / 750 - 800 peak	10.2, 10.6	Water
	400 average / 1000 peak	10.6	Water

* - Wavelength(s) options dependent on model selected

KEY COMPONENT OPTIONS (cont.)

2-Axis Scan Heads

Scan Head	Working Distance ¹	Usable Square Field Size (mm ²)	Typical Spot Size ² (μm)	Typical Depth of Field (mm)
MOVIA	100	65 x 65	240	± 3.5
MOVIA	200	130 x 130	485	± 14
MOVIA	300	195 x 195	730	± 32
VERSIA	100	67 x 67	175	± 1.75
VERSIA	200	135 x 135	350	± 7.5
VERSIA	300	205 x 205	525	± 16

1 – Working Distance give as typical distance from bottom of scanner body to working area. Actual values can vary by up to ±3%

2 – Spot Size diameters given for collimated gaussian beams with typical beam diameters and at $M^2 = 1.2$

Controller & Software

ScanMaster™ Controller (SMC) - designed to work seamlessly with all our Cambridge Technology's scan heads, while providing easy integration with an OEM's system. SMC is a self-contained controller that provides advanced hardware and software control technology to drive laser scanning systems using proprietary algorithms and predictive controls. The Ethernet connected SMC board permits remote embedding and control of a scan-head and laser system. It can control two scan-heads with concurrent laser timing control. It also provides integrated synchronization I/O for connection to factory automation equipment.

ScanMaster™ Designer (SMD) - powerful package of designer tools that conveniently support all standard file formats. With SMD you can create and scan virtually any image using graphical shapes, text, linear bar codes, 2D data matrix bar codes, QR-Codes, or imported raster images and graphics. SMD also features ScanScript, a powerful scripting language with a comprehensive library of commands for supporting any laser scanning scenario.

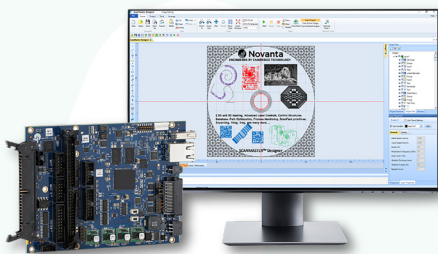

Basic System Architecture - the advantage of the SMD/SMC architecture is that it provides users with detailed laser processing control for multiple aspects of a project.

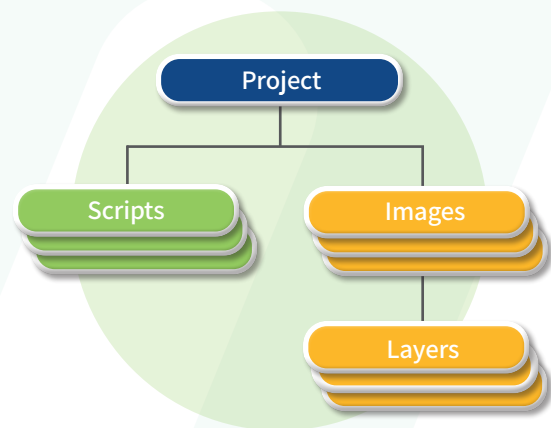

A job, represented in ScanMaster Designer as a Project consists of two entities — the Script and the Image. The Image is a drawing made up of one or more Layers that hold shapes and other elements (text strings, bar codes, and pictures). Layers simplify the creation of complex images and define the order of execution. The Script entity executes flow control, to support integration with the rest of the system, and to allow programmatic manipulation of Images and settings. There is no restriction on the number of Images and Scripts in a Project.

SMC/SMD HIGHLIGHTS

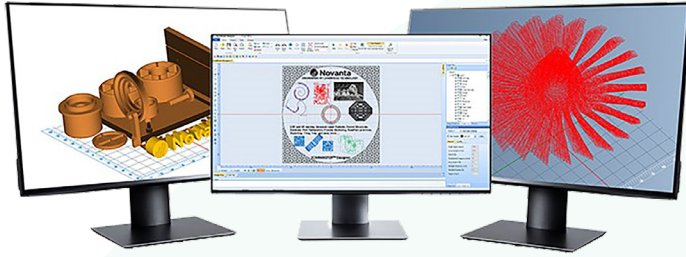

Single Software/Controller Solution – perfectly matched and designed in unison for optimal performance with built-in advance application features.



SyncMaster – advanced laser scanning head and XY linear stage synchronization expands work field size and fits production environments with unmatched accuracy and speed.

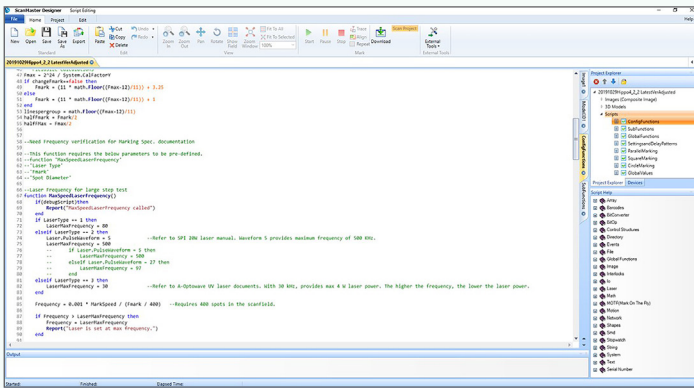

Built-In ScanScript – single solution for multiple applications includes application specific features.

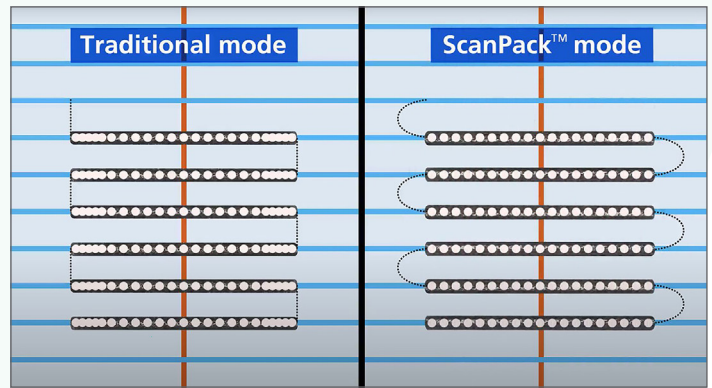

ScanPack Trajectory Planning – intelligent trajectory planning delivers faster throughput with higher accuracy.

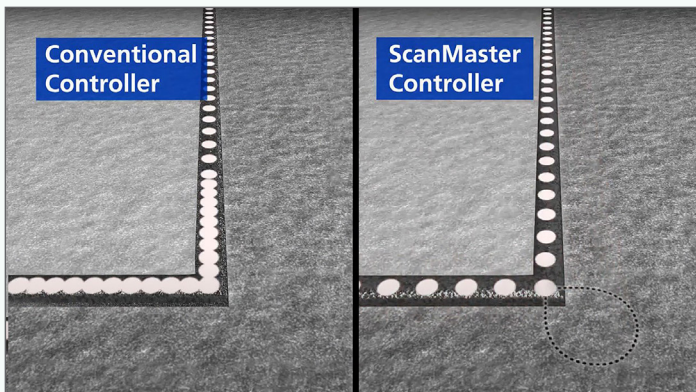

Skywriting – delivers uniform laser density when processing complex shapes and tight corners to avoid “burn marks” caused by over-processing.



Synchronization – high degree of stitching accuracy for multi-scanning head systems.

RECOMMENDED APPLICATIONS

Marking & Coding

Novanta Integrator Packages excel at marking and coding applications. A wide range of CO₂ laser power options matched with a scan head and industry leading controller/software, is ideally suited for single piece, batch processing, and high-speed applications.

Hatching Support – elaborate pattern support including checkerboard and helix with automatic hatch capability to produce vivid graphics and text.

Flexible File Import – import raster and vector images with automatic parameter set assignment.

Mark-on-the-Fly – stand-alone operation with real-time bar code and text rendering.

Tray Marking – unique step & repeat capability to extend the marking area for batch processing systems.

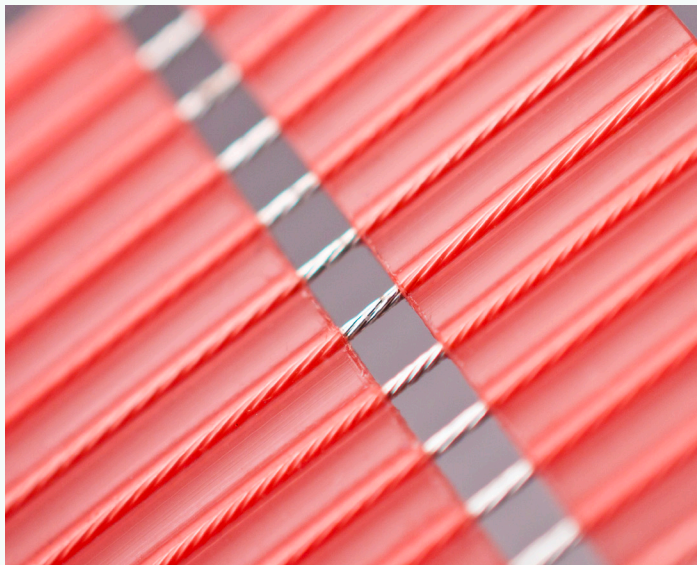

Converting

Laser processing systems are quickly becoming more popular in converting applications due to their flexibility, lower change-over costs, and lack of added consumables. Novanta's SMD/SMC solution optimizes laser processing systems for converting operations with practical features for system builders.

On-The-Fly Operability – highly precise synchronization between the source laser and scanning head delivers accurate cutting, scoring, and perforating patterns for in-motion and roll-to-roll systems.

Tiling – a step and repeat process that enables processing of areas larger than the laser processing area by synchronizing the laser processing sub-system with the movement of the processing bed.

Speed Compensation – automatic adjustment of laser parameters to match the speed of in-motion systems.

Material Processing

Laser material processing is broad and diverse. Novanta Integrator Packages are versatile and flexible, with exceptional cutting, scoring, perforating, ablating, and engraving performance.

ScanPack – improves throughput by optimizing scanner movement trajectory, eliminating the need for delay settings.

Skywriting – eliminates laser over-processing that cause burn marks and excessive edge melt by delivering uniform laser density.

Wobble – for sensitive welding applications, a repeating circular pattern distributes laser energy evenly across the wobble vector.

Hatching – elaborate pattern support enables complex laser patterning, especially useful for ablation to modify surface textures.

SyncMaster – expands work field size with advanced laser scanning head and XY linear stage synchronization.



DIMENSIONS

Dimensions are in mm (inches)



Integrator Package	Length mm (inches)	Width mm (inches)	Height mm (inches)	Weight kg (lbs.)
MOVIA / 48 Series	696.72 (27.43)	198.12 (7.8)	164.6 (6.48)	10.7 (23.5)
MOVIA / v Series	702.01 (27.64)	203.2 (8)	170.54 (6.714)	16.6 (36.5)
MOVIA / vi Series	702.01 (27.64)	203.2 (8)	170.54 (6.714)	14.4 (31.8)
MOVIA / ti Series	930.61 (36.64)	241.3 (9.5)	176.25 (6.94)	24.3 (53.5)
VERSIA / 48 Series	718.82 (28.30)	187.96 (7.4)	218.19 (8.59)	11.3 (24.8)
VERSIA / v Series	720.21 (28.35)	203.2 (8)	170.54 (6.714)	17.2 (37.8)
VERSIA / vi Series	720.21 (28.35)	203.2 (8)	170.54 (6.714)	15.0 (33.1)
VERSIA / ti Series	948.81 (37.355)	241.3 (9.5)	176.25 (6.94)	24.9 (54.8)
VERSIA / f Series	1612.08 (63.47)	355.6 (14)	210.72 (8.3)	79.1 (174.4)
VERSIA / i Series	1612 (63.47)	356 (14)	375 (14.75)	96.9 (213.7)
VERSIA / p100	948.81 (37.355)	241.3 (9.5)	238.23 (9.38)	23.7 (52.2)
VERSIA / p150	1063.11 (41.855)	206.76 (8.14)	238.23 (9.38)	28.1 (62.0)
VERSIA / p250	1612 (63.47)	356 (14)	224 (8.82)	83.4 (184)
VERSIA / p400	1612 (63.47)	356 (14)	375 (14.75)	96.6 (213)

CONTACT US

Americas, Asia Pacific

Novanta Headquarters
Bedford, USA
P +1-781-266-5700

Photonics@Novanta.com

Europe, Middle East, Africa

Novanta Europe GmbH
Wackersdorf, Germany
P +49 9431 7984-0

Milan, Italy
P +39-039-793-710

Photonics@Novanta.com

China

Novanta Sales & Service Office
Shenzhen, China
P +86-755-8280-5395

Suzhou, China
P +86-512-6283-7080

Photonics.China@Novanta.com

Japan

Novanta Service & Sales Office
Tokyo, Japan
P +81-3-5753-2460

Photonics.Japan@Novanta.com