

## p100/150 Operator's Manual



---

**SYNRAD**<sup>®</sup>

A Novanta Company

4600 Campus Place  
Mukilteo, WA 98275

1.800.SYNRAD1

tel 1.425.349.3500

fax 1.425.349.3667

e-mail [synrad@synrad.com](mailto:synrad@synrad.com)

web [www.synrad.com](http://www.synrad.com)

# p100/150 Operator's Manual

**Version 2.9**

SYNRAD® is a registered trademark of Novanta Corporation. ©Novanta Corporation 2019. All Rights Reserved. No reproduction without written authorization.

DATE: July 2019

# Table of contents

## Introduction 1

- Chapter Introduction Summary.....5
- Trademark & Copyright information .....6
- Warranty information .....7
- Sales and Applications .....8
- Customer Service .....8
- Technical Support .....8
- Reference materials .....8
- EU headquarters .....9
- Guidelines & Content.....10
- Packaging, Storage/shipping, Mounting, Connecting and Cooling.....10
- Contents Description (p100 Laser).....10
- Contents Description (p150 Laser).....11
- Contents Description (Continued) .....12
- Pulstar™ nomenclature & model numbers.....13
- Nomenclature (Continued).....14

## Laser Safety 2

- Hazard Information .....16
- Terms.....16
- General hazards .....17
- General hazards (Continued) .....18
- Other hazards .....19
- Disposal .....19
- Additional laser safety information .....19
- Pulstar™ p100 label locations.....20
- Pulstar™ p150 label locations.....21
- Agency compliance.....22

## Operation 3

- Controls & Indicators.....29
- Start-up and pulsed operation .....29
- Controls and indicators .....30
- OEM p100/150 front panel .....30
- OEM p100/150 rear panel .....31

# Table of contents

## Technical Reference 4

- Technical overview .....34
- Laser tube and design .....34
- Optical setup.....36
- Optical isolator .....37
- Beam delivery .....38
- Focusing optics .....38
- RF power supply .....43
- Control signals.....44
- Operation modes .....45
- User I/O connection summary.....55
- Input/output signals .....57
- Sample I/O circuits.....63
- DC power cables.....67
- Keypress functions .....68
- Shutter functions.....69
- Remote interlock functions .....69

## Maintenance & Troubleshooting 6

- Disabling the p100/150 laser .....79
- Daily inspections .....79
- Storage/shipping.....80
- Operational flowchart .....84
- Status LEDs .....85
- Laser fault indications.....87
- DC Pre-Charge fault.....89
- No-Strike fault.....89
- Humidity fault.....89
- Frequency Limit fault .....90
- Duty Cycle/Pulse Width Limit fault .....90
- Cleaning optical components .....91

## Index

- Index .....93

# Introduction

# 1

## Chapter Introduction Summary

- Pulstar™ Trademark, copyright, contact (service & support) information
- Pulstar™ Nomenclature

**Important Note:**  This Operation Manual explains operation activities related to Pulstar p100/150 lasers. If you cannot operate the unit using the information described in this manual, contact SYNRAD® (+1.425.349.3500) or an authorized SYNRAD Distributor.

Lift the laser only by the mounting feet or baseplate. Do not lift or support the laser by its cooling fittings.

Please reference the [Quick Start Guide](#) for unpacking, mounting, and connecting.

Failure to properly package the laser using SYNRAD shipping box and foam/cardboard inserts as shown in Packaging Instructions may void the warranty. Customers may incur additional repair charges due to shipping damage caused by improper packaging.

Before beginning any maintenance or inspections of your p100/150 laser, be sure to completely disable the laser by disconnecting the DC Power cable (or cables) from the rear of the laser.

### Caution Possible Equipment Damage



A **risk of exposure** to toxic elements may result when certain optical or beam delivery components are damaged. In the event of damage to laser, marking head, or beam delivery optics, contact SYNRAD, or the optics manufacturer for handling instructions.

If you **operate your laser in dirty or dusty environments**, contact SYNRAD about the risks of doing so and precautions you can take to increase the longevity of your laser, marking head, and associated optical components.

### Warning Serious personal injury



Remote interlock faults are not latched on OEM lasers. Clearing the fault condition re-enables the RDY indicator and the laser will fire immediately provided the SHT indicator is lit and a PWM Command signal is applied.

Because exposure to CO<sub>2</sub> laser radiation in the (9-11) μm range can inflict severe corneal injuries and seriously burn human tissue, the OEM or System Integrator must ensure that appropriate safeguards are in place to prevent unintended lasing.

# Introduction

## Introduction Summary (Continued):

**Warning**  
**Serious**  
**personal**  
**injury**



A **risk of exposure** to toxic elements may result when certain optical or beam delivery components are damaged. In the event of damage to laser, marking head, or beam delivery optics, contact SYNRAD, or the optics manufacturer for handling instructions.

The use of the Quick Start Plug bypasses the laser's safety interlock function, potentially exposing personnel in the area to invisible infrared laser radiation. The Quick Start Plug is intended only for initial testing and troubleshooting by qualified personnel. In normal operation, the laser's Remote Interlock input should be connected to the machine's safety interlock circuitry.

## Trademark & Copyright information

SYNRAD® and Pulstar™ are registered trademarks of SYNRAD.

All other trademarks or registered trademarks are the property of their respective owners.

© 2019 by SYNRAD.  
All rights reserved.

# Introduction

## Warranty information

This is to certify that Pulstar™ p100/150 lasers are guaranteed by SYNRAD® to be free of all defects in materials and workmanship for a period of two years from the date of shipment. This warranty does not apply to any defect caused by negligence, misuse (including environmental factors), accident, alteration, or improper maintenance. This includes, but is not limited to, damage due to corrosion, condensation, or failing to supply properly conditioned purge gas.

We request that you examine each shipment within 10 days of receipt and inform SYNRAD of any shortage or damage. If no discrepancies are reported, SYNRAD shall assume the shipment was delivered complete and defect-free.

If, within two years from the date of shipment, any part of the Pulstar p100/150 laser should fail to operate, contact the SYNRAD Customer Service department at 1.800.SYNRAD1 (outside the U.S. call 1.425.349.3500) and report the problem. When calling for support, please be prepared to provide the date of purchase, model number and serial number of the unit, and a brief description of the problem. When returning a unit for service, a Return Authorization (RA) number is required; this number must be clearly marked on the outside of the shipping container in order for the unit to be properly processed. If replacement parts are sent to you, then you are required to send the failed parts back to SYNRAD for evaluation unless otherwise instructed.

If your Pulstar p100/150 laser fails within the first 45 days after shipment, SYNRAD will pay all shipping charges to and from SYNRAD when shipped as specified by SYNRAD Customer Service. After the first 45 days, SYNRAD will continue to pay for the costs of shipping the repaired unit or replacement parts back to the customer from SYNRAD. The customer, however, will be responsible for shipping charges incurred when sending the failed unit or parts back to SYNRAD or a SYNRAD Authorized Distributor. In order to maintain your product warranty and to ensure the safe and efficient operation of your Pulstar p100/150 laser, only authorized SYNRAD replacement parts can be used. This warranty is void if any parts other than those provided by SYNRAD are used.

SYNRAD and SYNRAD Authorized Distributors have the sole authority to make warranty statements regarding SYNRAD products. SYNRAD and its Authorized Distributors neither assumes nor authorizes any representative or other person to assume for us any other warranties in connection with the sale, service, or shipment of our products. SYNRAD reserves the right to make changes and improvements in the design of our products at any time without incurring any obligation to make equivalent changes in products previously manufactured or shipped. Buyer agrees to hold SYNRAD harmless from any and all damages, costs, and expenses relating to any claim arising from the design, manufacture, or use of the product, or arising from a claim that such product furnished buyer by SYNRAD, or the use thereof, infringes upon any Patent, foreign or domestic.

# Introduction

## Service & support information

SYNRAD® worldwide headquarters are located north of Seattle in Mukilteo, Washington. U.S.A. Our mailing address is:

SYNRAD  
4600 Campus Place  
Mukilteo, WA 98275  
U.S.A.

Phone us at: 1.800.SYNRAD1 (1.800.796.7231)  
Outside the U.S.: +1.425.349.3500  
Fax: +1.425.349.3667  
E-mail: [synrad@synrad.com](mailto:synrad@synrad.com)

## Sales and Applications

SYNRAD Regional Sales Managers work with customers to identify and develop the best CO<sub>2</sub> laser solution for a given application. Because they are familiar with you and your laser application, use them as a first point of contact when questions arise. Regional Sales Managers also serve as the liaison between you and our Applications Lab in processing material samples per your specifications. To speak to the Regional Sales Manager in your area, call SYNRAD at 1.800.SYNRAD1.

## Customer Service

For assistance with order or delivery status, service status, or to obtain a Return Authorization (RA) number, contact SYNRAD at 1.800.SYNRAD1 and ask to speak to a Customer Service representative, or you can email us by sending a message to [customercare@synrad.com](mailto:customercare@synrad.com).

## Technical Support

SYNRAD Regional Sales Managers are able to answer many technical questions regarding the installation, use, troubleshooting, and maintenance of our products. In some cases, they may transfer your call to a Laser, Marking Head, or Software Support Specialist. You may also e-mail questions to the Technical Support Group by sending your message to [customercare@synrad.com](mailto:customercare@synrad.com).

## Reference materials

Your Regional Sales Manager can provide reference materials including Outline & Mounting drawings, Operator's Manuals, Technical Bulletins, and Application Newsletters. Most of these materials are also available directly from SYNRAD web site at <http://www.synrad.com>.



# Introduction

## EU headquarters

For assistance in Europe, contact SYNRAD® European subsidiary, SYNRAD Europe, at:

©Novanta Distribution (USD) GmbH  
Parkring 57-59  
85748 Garching bei München,  
Germany

Phone: +49 89 31707-0

web: [www.synrad.com](http://www.synrad.com)

E-mail: [EMEA-service@novanta.com](mailto:EMEA-service@novanta.com)

# Introduction

## Guidelines & Content

Refer to the drawings, located in the technical reference chapter, when installing and operating your Pulstar™ p100/150 laser. Also reference the [p100/150 quick start guide](#) located on our website.

- Unpacking/Packing, Storage/Shipping, Mounting, Connecting, Cooling, Contents
- p100/150 nomenclature/features

## Unpacking/packing, Storage/shipping, Mounting, Connecting and Cooling

SYNRAD® recommends saving all of the laser's original packaging. This specially designed packaging will protect the laser from damage during storage, relocation and/or shipping. Reference the drawings in the technical references section of this manual and the Quick Start Guide Series at [Synrad.com](#) for re-packaging p100/150 laser.

See the drawings located on our website [Synrad.com](#), or in the technical reference chapter in this operation manual mounting sections in the p100/150 Quick Start Guide located on our website. When mounting the laser, use only one metric or SAE fastener per mounting tab on the baseplate. Do not use any type of jackscrew arrangement as this will twist the baseplate and may distort the tube.

## Contents Description (p100 Laser)

Customer Communication Flier– Instead of the laser manual CD, please follow the instructions for our latest laser [manual\(s\)](#) located on our website.

Pulstar p100 Pulsed Laser – The Pulstar p100 laser is a compact laser generating 100 W average power and peak power greater than 390 W with rise times less than 40 microseconds ( $\mu$ s).

Quick Start Plug p100 – Connects to the User I/O connector. Jumpers are built into the plug to enable the laser's interlock circuits for initial start-up and testing.

DC Power Cable Set (not shown) p100 – Connects 48 VDC from the DC power supply to the Pulstar p100 laser. Standard cable length is 1.8 meters (6.0 ft).

Cooling Tubing p100– Carries cooling water from the chiller (not included) to the laser and back. This black polyethylene tubing is 12mm O.D. by 30 feet and must be cut to length.

Mounting Bolts & Metric Mounting Screws (not shown) p100– Three each 1/4–20 × 5/8" UNC capscrews are provided for mounting the Pulstar p100 laser to your mounting surface. Two sets of three (3) M6x1x16mm mounting screws are included.

# Introduction

## Contents Description (p 100 Laser Continued)

Gas Purge Kit p100– Provides a filtering and connection point to the laser from your facility's gas purge system.

Cooling Kit p100– Adapts the laser's straight 1/2-inch coolant fittings to 90° adapter fittings for either 1/2-inch standard or 12-mm metric cooling tubing.

Spare Fuses (not shown) p100– Fast-acting mini ATO-type fuses protects the Pulstar™ internal circuitry.

Final Test Report (not shown) p100– Contains data collected during the laser's final pre-shipment test.

## Contents Description (p150 Laser)

Customer Communication Flier– Instead of the laser manual CD, please follow the instructions for our latest laser [manual\(s\)](#) located on our website.

Pulstar p150 Pulsed Laser- The Pulstar p150 laser is a compact laser generating 150 W average power and peak power greater than 600 W with rise times less than 50 microseconds ( $\mu$ s).

Quick Start Plug p150 – connects to the User I/O connector. Jumpers are built into the plug to enable the laser's interlock circuits for initial start-up and testing.

DC Power Cable Set (not shown) p150 – connects 48 VDC from the DC power supply to the Pulstar p150 laser. Standard cable length is 1.8 meters (6.0 ft).

Cooling Tubing p150– carries cooling water from the chiller (not included) to the laser and back. This black polyethylene tubing is 12mm O.D. by 30 feet and must be cut to length.

Mounting Bolts & Metric Mounting Screws (not shown) p150– Three each 1/4–20 × 5/8" UNC capscrews are provided for mounting the Pulstar p150 laser to your mounting surface. Two sets of three (3) M6x1x16mm mounting screws are included.

Gas Purge Kit p150– provides a filtering and connection point to the laser from your facility's gas purge system.

Cooling Kit p150– adapts the laser's straight 1/2-inch coolant fittings to 90° adapter fittings for either 1/2-inch standard or 12-mm metric cooling tubing.

Spare Fuses (not shown) p150– fast-acting mini ATO-type fuses protects the Pulstar internal circuitry.

Final Test Report (not shown) p150– contains data collected during the laser's final pre-shipment test.

# Introduction

## Contents Description (Continued)

Table 1-1 Pulstar p100 ship kit contents.

Shipping Box Contents	Qty	Shipping Box Contents	Qty
Pulstar p100 Pulsed Laser.....	1	Mounting Bolts .....	3 (Not standard)
Laser Manual url.....	1	Gas Purge Kit.....	1
Quick Start Plug .....	1	Cooling Kit .....	1
Cooling Tubing.....	1	Spare Fuses (not shown).....	2
DC Power Cable Set (not shown) ...	1	Final Test Report (not shown) ....	1

Table 1-2 Pulstar p150 ship kit contents.

Shipping Box Contents	Qty	Shipping Box Contents	Qty
Pulstar p150 Pulsed Laser.....	1	Mounting Bolts .....	3 (Not standard)
Laser Manual url.....	1	Gas Purge Kit.....	1
Quick Start Plug .....	1	Cooling Kit .....	1
Cooling Tubing.....	1	Spare Fuses (not shown).....	2
DC Power Cable Set (not shown) ...	1	Final Test Report (not shown) ....	1

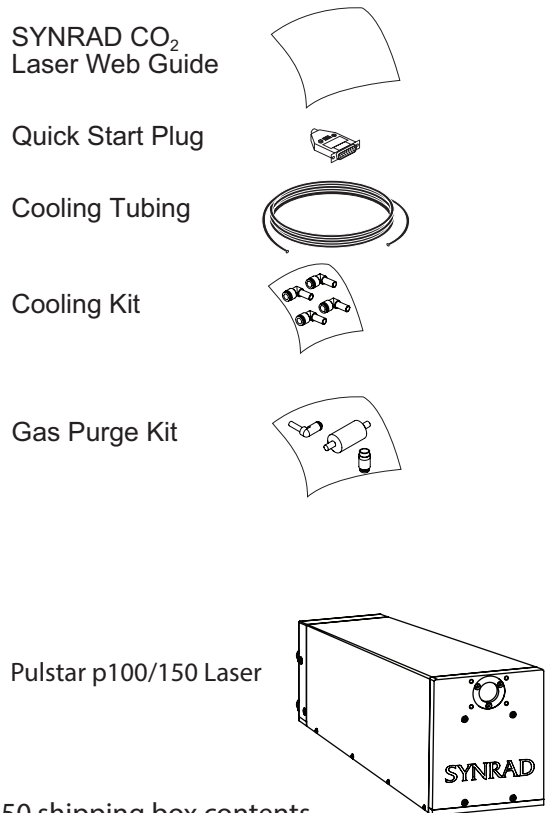

Figure 1-1 Firestar p100/150 shipping box contents

# Introduction

## Pulstar™ nomenclature & model numbers

The Pulstar nomenclature section includes:

- p100/150 laser versions
- Model numbers

The SYNRAD® Pulstar high peak power line of pulse CO<sub>2</sub> lasers includes: p100, p150, p250 and the p400. Pulstar p100 lasers are currently available only as OEM lasers and are designed primarily for integration into larger processing systems by the Original Equipment Manufacturer (OEM) or System Integrator who bears the responsibility for meeting the appropriate laser safety requirements for Class 4 laser systems.

As an Original Equipment Manufacturer or (OEM) laser, the p100/150 do not comply with 21 CFR, Subchapter J or EN 60825-14 without additional safeguards.

Designed primarily for pulse operation, the p100/150 is still controlled by a PWM Command signal; however, the duty is limited to maximum duty cycle of 37.5% and a maximum pulse length of 600 microseconds (µs) typical. The p100/150's pulsed RF design overdrives the laser gas, resulting in substantially higher peak power (600W typical) than our ti-Series CW laser even though the average power output of these two lasers is almost the same. Like our integrated ti-Series lasers, the p100/150 features a built-in RF power supply so no external RF cables are required. This compact, lightweight design mounts easily to flatbed cutters, robotic arms, or gantry systems making integration into your production line simple and fast.

The last three characters in the Pulstar model number serve to designate the functional category, cooling method, and model version. The functional category is indicated by either a "K" for Keyswitch or "S" (Switch-less) for OEM models. The next letter indicates the cooling method: "W" for water-cooled units, "F" for fan-cooled units, and "A" for air-cooled lasers (the "W" is omitted on p-Series lasers because they are all water-cooled). The last letter in the model number indicates the current model version beginning with "B". The Pulstar OEM p100 laser is available only in an OEM water-cooled configuration so model number PSP100SB designates a "B" version OEM water-cooled laser.

# Introduction

## Nomenclature (Continued)

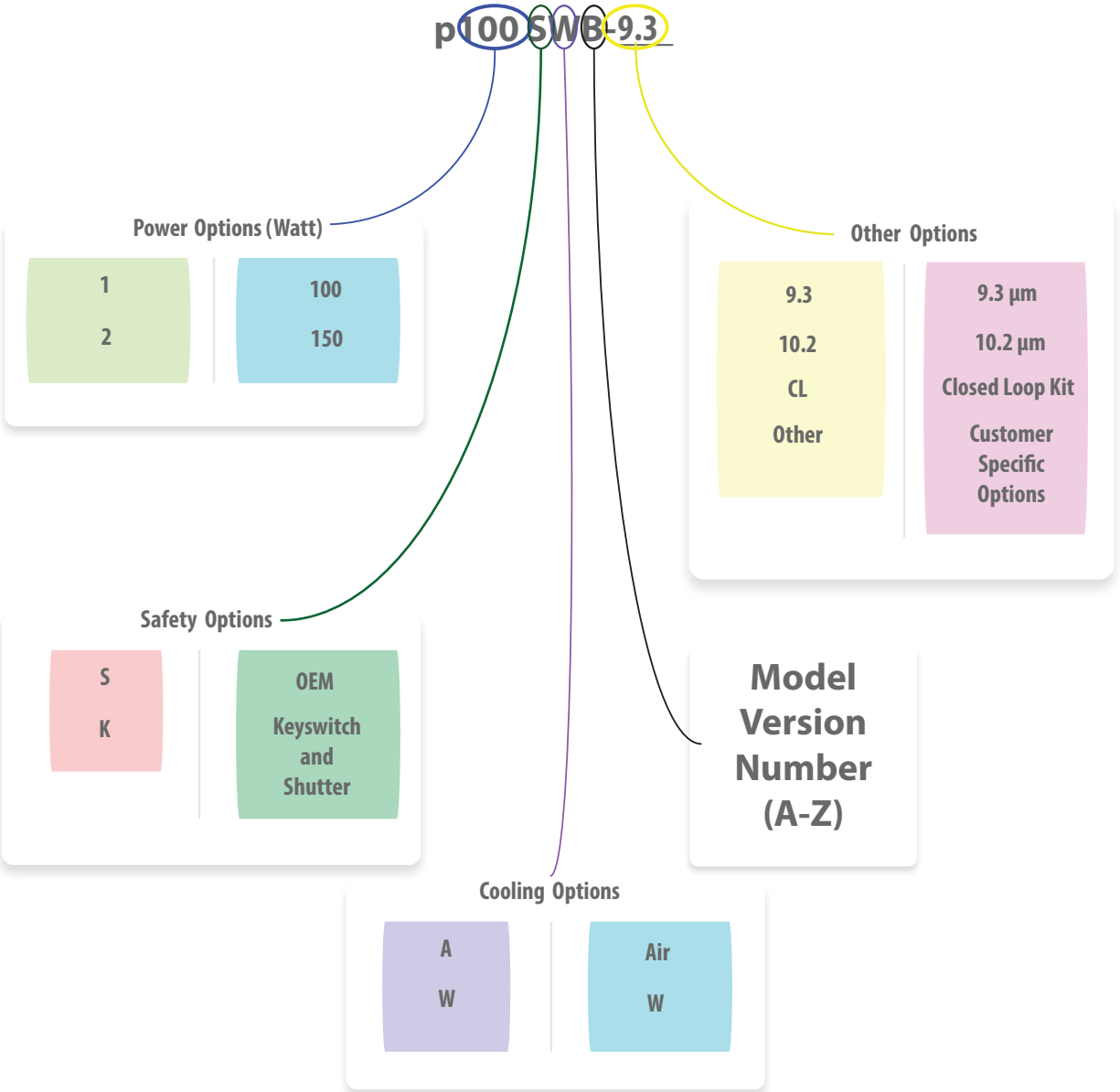

Figure 1-2 Anatomy of a model number.

# Laser Safety

## 2

This chapter contains safety information that you will need to know prior to getting started.

- Hazard Information – includes equipment label terms and hazards, please familiarize yourself with all definitions and their significance.
- General & Other Hazards – provides important information about the hazards and unsafe practices that could result in death, severe injury, or product damage.
- Disposal – information on your p100/150 laser parts and/or components as they pertain to disposal.
- Additional Safety Information – describes how to find additional information about your p100/150 laser.
- Compliance – explains in the subsections therein applicable and appropriate regulation information.

Note: Read the entire safety section. This will ensure you are familiar with the hazards and warnings prior to starting.

### **Warning**

### **Serious personal injury**



**This Class 4 CO<sub>2</sub> laser product emits invisible infrared laser radiation in the 9.3–10.6 μm wavelength band.**

**Because direct or diffuse laser radiation can inflict severe corneal injuries, always wear eye protection when in the same area as an exposed laser beam.**

**Do not allow the laser beam to contact a person!**

**This product emits an invisible laser beam that is capable of seriously burning human tissue.**

**Always be aware of the beam's path and always use a beam block while testing.**

# Laser Safety

## Hazard Information

Hazard information includes terms, symbols, and instructions used in this manual or on the equipment to alert both operating and service personnel to the recommended precautions in the care, use, and handling of Class 4 laser equipment.

## Terms

Certain terms are used throughout this manual or on the equipment labels. Please familiarize yourself with their definitions and significance.









Parameter	Description
 	<p><b>WARNING:</b> Potential &amp; Imminent hazards which, if not avoided, could result in death or serious injury.</p> <p>Alerts operator of serious dangers, hazardous radiation, hazardous voltages, vapor hazard, &amp; reflective dangers.</p>
	<p><b>DANGER:</b> Hazards which, if not avoided, could result in minor or moderate injury.</p> <p>Alerts operator of lifting dangers.</p>
	<p><b>CAUTION:</b> Potential hazards or unsafe practices which, if not avoided, may result in product damage.</p> <p>Alerts operator of equipment dangers.</p>
  	<p><b>IMPORTANT NOTES &amp; TIPS:</b></p> <p>Content specific information and/or recommendations.</p>

Figure 2-1 Labeling terms and definitions.

**Warning**  
**Serious personal injury**



For laser systems being used or sold within the U.S.A., customers should refer to and follow the laser safety precautions described American National Standards Institute (ANSI) document Z136.1-2007, Safe Use of Lasers.



For laser systems being used or sold outside the U.S.A., customers should refer to and follow the laser safety precautions described in European Normative and International Electrotechnical Commission documents IEC/ TR 60825-14:2014, Safety of Laser Products – Part 14: A User's Guide.



# Laser Safety

## General hazards

Following are descriptions of general hazards and unsafe practices that could result in death, severe injury, or product damage. Specific warnings and cautions not appearing in this section are found throughout the manual.

### **Warning**

**Serious  
personal  
injury**



**Do not allow laser radiation to enter the eye** by viewing direct or reflected laser energy.

**CO<sub>2</sub> laser radiation can be reflected from metallic objects** even though the surface is darkened. Direct or diffuse laser radiation can inflict severe corneal injuries leading to permanent eye damage or blindness. All personnel must wear eye protection suitable for CO<sub>2</sub> radiation, e.g. 9.3–10.6 μm when in the same area as an exposed laser beam.

**Eye wear protects against scattered energy** but is not intended to protect against direct viewing of the beam—never look directly into the laser output aperture or view scattered laser reflections from metallic surfaces.

**Enclose the beam path whenever possible. Exposure to direct or diffuse CO<sub>2</sub> laser radiation can seriously burn human or animal tissue, which may cause permanent damage.**

**This product is not intended for use in explosive, or potentially explosive, atmospheres!**

**Materials processing with a laser can generate air contaminants such as vapors, fumes, and/or particles that may be noxious, toxic, or even fatal. Material Safety Data Sheets (MSDS) for materials being processed should be thoroughly evaluated and the adequacy of provisions for fume extraction, filtering, and venting should be carefully considered. Review the following references for further information on exposure criteria:**

**ANSI Z136.1-2014, Safe Use of Lasers, section 7.3.**

**U.S. Government's Code of Federal Regulations: 29 CFR 1910, Subpart Z.**

**Threshold Limit Values (TLV's) published by the American Conference of Governmental Industrial Hygienists (ACGIH).**

**It may be necessary to consult with local governmental agencies regarding restrictions on the venting of processing vapors.**

**The use of aerosol dusters containing difluoroethane causes "blooming", a condition that significantly expands and scatters the laser beam. This beam expansion can effect mode quality and/or cause laser energy to extend beyond the confines of optical elements in the system, possibly damaging acrylic safety shielding. Do not use air dusters containing difluoroethane in any area adjacent to CO<sub>2</sub> laser systems because difluoroethane persists for long time periods over wide areas.**

# Laser Safety

## General hazards (Continued)

Pulstar™ p100/150 lasers should be installed and operated in manufacturing or laboratory facilities by trained personnel only. Due to the considerable risks and hazards associated with the installation and operational use of any equipment incorporating a laser, the operator must follow product warning labels and instructions to the user regarding laser safety. To prevent exposure to direct or scattered laser radiation, follow all safety precautions specified throughout this manual and exercise safe operating practices per ANSI Z136.1-2014, Safe Use of Lasers at all times when actively lasing.

Due to the specific properties of laser light, a unique set of safety hazards that differ from other light sources must be considered. Just like light, lasers can be reflected, refracted, diffracted or scattered.



Figure 2-2 Always wear safety glasses or protective goggles with side shields to reduce the risk of damage to the eyes when operating the laser.

A CO<sub>2</sub> laser is an intense energy source and will ignite most materials under the proper conditions. Never operate the laser in the presence of flammable or explosive materials, gases, liquids, or vapors.

**Warning**  
**Serious personal injury**

“Caution  - The use of controls or adjustments or performance of procedures other than those specified herein may result in hazardous radiation exposure.”



Safe operation of the laser requires the use of an external beam block to safely block the beam from traveling beyond the desired work area. Do not place your body or any combustible object in the path of the laser beam. Use a water-cooled beam dump or power meter, or similar non-scattering, noncombustible material as the beam block. Never use organic material or metals as the beam blocker; organic materials, in general, are apt to combust or melt and metals act as specular reflectors which may create a serious hazard outside the immediate work area.

Always wear safety glasses or protective goggles with side shields to reduce the risk of damage to the eyes when operating the laser.

# Laser Safety

## Other hazards

The following hazards are typical for this product family when incorporated for intended use: (A) risk of injury when lifting or moving the unit; (B) risk of exposure to hazardous laser energy through unauthorized removal of access panels, doors, or protective barriers; (C) risk of exposure to hazardous laser energy and injury due to failure of personnel to use proper eye protection and/or failure to adhere to applicable laser safety procedures; (D) risk of exposure to hazardous or lethal voltages through unauthorized removal of covers, doors, or access panels; (E) generation of hazardous air contaminants that may be noxious, toxic, or even fatal.

## Disposal

This product contains components that are considered hazardous industrial waste. If a situation occurs where the laser is rendered non-functional and cannot be repaired, it may be returned to SYNRAD® who, for a fee, will ensure adequate disassembly, recycling and/or disposal of the product.

## Additional laser safety information

The SYNRAD web site (<http://www.synrad.com/LaserFacts/safetyinfo.html>) contains an online laser safety handbook that provides information on (1) Laser Safety Standards for OEM's/System Integrators, (2) Laser Safety Standards for End Users, (3) References and Sources, and (4) Assistance with Requirements.

In addition, the Occupational Safety and Health Administration (OSHA) provides an online Technical Manual (located at [http://www.osha.gov/dts/osta/otm/otm\\_iii/otm\\_iii\\_6.html](http://www.osha.gov/dts/osta/otm/otm_iii/otm_iii_6.html)). Section III, Chapter 6 and Appendix III are good resources for laser safety information. Another excellent laser safety resource is the Laser Institute of America (LIA). Their comprehensive web site is located at <http://www.lia.org>.

# Laser Safety

## Pulstar™ p100 label locations

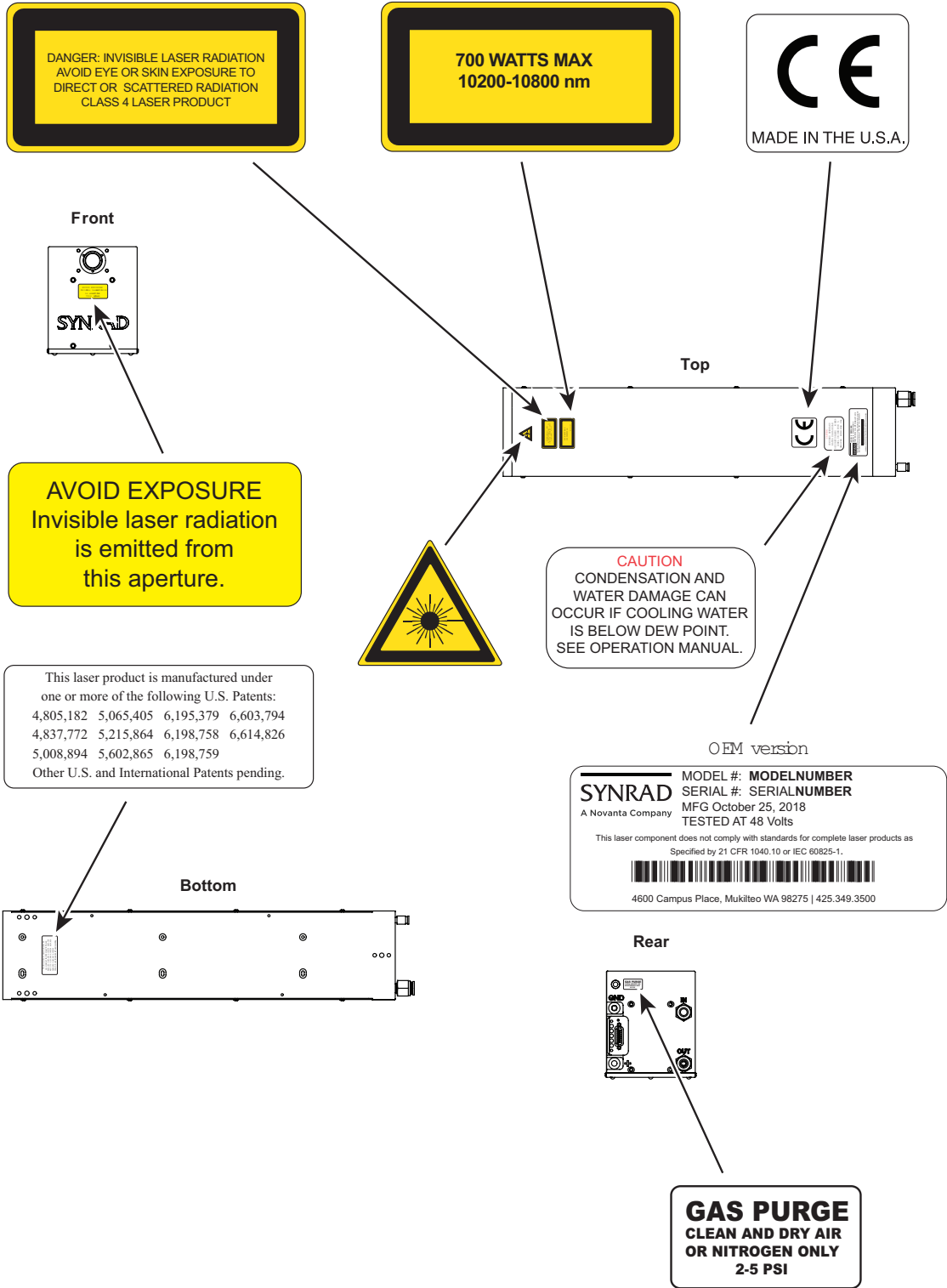

Figure 2-3 Pulstar p100 hazard label locations.

# Laser Safety

## Pulstar™ p150 label locations

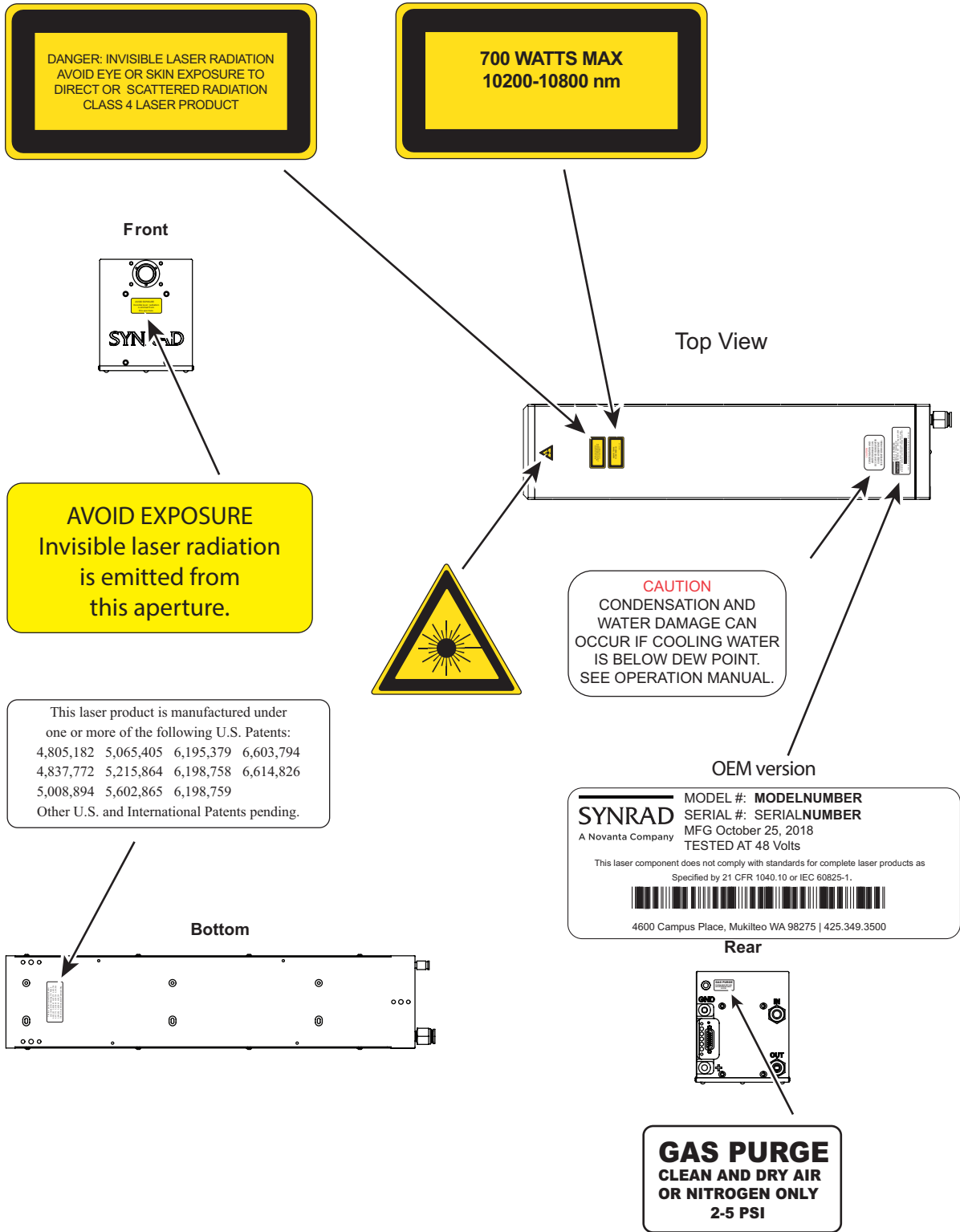

Figure 2-4 Pulstar p150 hazard label locations.

# Laser Safety

## Agency compliance

- Center for Devices and Radiological Health (CDRH) requirements.
- Federal Communications Commission (FCC) requirements.
- European Union (EU) requirements.

SYNRAD® lasers are designed, tested, and certified to comply with certain United States (U.S.) and European Union (EU) regulations. These regulations impose product performance requirements related to electromagnetic compatibility (EMC) and product safety characteristics for industrial, scientific, and medical (ISM) equipment. The specific provisions to which systems containing Pulstar™ p100/150 lasers must comply are identified and described in the following paragraphs. Note that compliance to CDRH, FCC, and EU requirements depends in part on the laser version selected—Keyswitch or OEM.

In the U.S., laser safety requirements are governed by the Center for Devices and Radiological Health (CDRH) under the auspices of the U.S. Food and Drug Administration (FDA) while radiated emission standards fall under the jurisdiction of the U.S. Federal Communications Commission (FCC). Outside the U.S., laser safety and emissions are governed by European Union (EU) Directives and Standards.

In the matter of CE-compliant laser products, SYNRAD, assumes no responsibility for the compliance of the system into which the product is integrated, other than to supply and/or recommend laser components that are CE marked for compliance with applicable European Union Directives.

Because OEM laser products are intended for incorporation as components in a laser processing system, they do not meet all of the Standards for complete laser processing systems as specified by 21 CFR, §1040 or EN 30825-1. SYNRAD, assumes no responsibility for the compliance of the system into which OEM laser products are integrated.

## Center for Devices and Radiological Health (CDRH) requirements

Product features incorporated into the design of Pulstar p100/150 lasers to comply with CDRH requirements are integrated as panel controls or indicators, internal circuit elements, or input/output signal interfaces. Specifically, these features include a laser and laser ready indicators, remote interlock for power on/off, a laser aperture shutter switch, and a five-second delay between power on and lasing. Incorporation of certain features is dependent on the laser version (Keyswitch or OEM). Table 2-1, Class 4 safety features, indicates which features are available on p100/150 lasers, the type and description of the feature, and if the feature is required by CDRH regulations.

## OEM models

Pulstar™ p100/150 OEM lasers are OEM products intended for incorporation as components in laser processing systems. As supplied by SYNRAD, these lasers do not meet the requirements of 21 CFR, Laser Products without additional safeguards. In the U.S., the Buyer of these OEM laser components is solely responsible for the assurance that the laser processing system sold to an end user complies with all laser safety requirements before the actual sale of the system. Under CDRH regulations, the Buyer must submit a report to the CDRH prior to shipping the system. In jurisdictions outside the U.S., it is the sole responsibility of the Buyer of these OEM

# Laser Safety

components to ensure that they meet all applicable local laser safety requirements. In cases where the Buyer is also the end-user of the OEM laser product, the Buyer/end-user must integrate the laser so that it complies with all applicable laser safety standards as set forth above.

## Federal Communications Commission (FCC) Requirements

The United States Communication Act of 1934 vested the Federal Communications Commission (FCC) with the authority to regulate equipment that emits electromagnetic radiation in the radio frequency spectrum. The purpose of the Communication Act is to prevent harmful electromagnetic interference (EMI) from affecting authorized radio communication services. The FCC regulations that govern industrial, scientific, and medical (ISM) equipment are fully described in 47 CFR, §18, §5C.

SYNRAD® Pulstar™ p100/150 lasers have been tested and found to comply by demonstrating performance characteristics that have met or exceeded the requirements of 47 CFR, §18, §5C for Radiated and Conducted Emissions.

## FCC information to the user

**Note:** The following FCC information to the user is provided to comply with the requirements of 47 CFR, §18, §5C 213 Information to the user.

### Interference Potential

In our testing, SYNRAD, has not discovered any significant electrical interference traceable to Pulstar p100/150 lasers.

### System Maintenance

Ensure that all exterior covers are properly fastened in position.

### Measures to Correct Interference

If you suspect that your Pulstar laser interferes with other equipment, take the following steps to minimize this interference:

- 1 Use shielded cables to and from the equipment that is experiencing interference problems.
- 2 Ensure that the Pulstar laser is properly grounded to the same electrical potential as the equipment or system it is connected to.

## FCC caution to the user

The Federal Communications Commission warns the user that changes or modifications of the unit not expressly approved by the party responsible for compliance could void the user's authority to operate the equipment.

# Laser Safety

## European Union (EU) requirements

### RoHS compliance

SYNRAD® Pulstar™ p100/150 lasers meet the requirements of the European Parliament and Council Directive 2015/863/EU on the Restriction of the Use of Certain Hazardous Substances in Electrical and Electronic Equipment that establishes maximum concentration values for certain hazardous substances in electrical and electronic equipment.

### Laser safety standards

Under the Low Voltage Directive, 2014/35/EU, the International Standard specifies the minimum documentation, marking and labeling for all laser products classified in accordance with EN 60825-1:2014 including laser diodes and all laser devices defined in ISO 11145 was developed to provide laser safety guidance and includes clauses on Engineering Specifications, Labeling, Other Informational Requirements, Additional Requirements for Specific Laser Products, Classification, and Determination of the Accessible Emission Level. To develop a risk assessment plan/laser safety program for users, see the EN 60825-14:2004 Standard for the safety of laser products that includes clauses on Administrative Policies, Laser Radiation Hazards, Determining the MPE, Associated Hazards, Evaluating Risk, Control Measures, Maintenance of Safe Operation, Incident Reporting and Accident Investigation, and Medical Surveillance.

### OEM models

Pulstar p100/150 OEM lasers are OEM products intended for incorporation as components in laser processing systems. As supplied by SYNRAD, these lasers do not meet the requirements of EN 60825-1 without additional safeguards. European Union Directives state that “OEM laser products which are sold to other manufacturers for use as components of any system for subsequent sale are not subject to this Standard, since the final product will itself be subject to the Standard.” This means that Buyers of OEM laser components are solely responsible for the assurance that the laser processing system sold to an end-user complies with all laser safety requirements before the actual sale of the system. Note that when an OEM laser component is incorporated into another device or system, the entire machinery installation may be required to conform to EN 60825-1:2004; EN 60204-1:2016, Safety of Machinery; the Machinery Directive, 2006/42/EC; and/or any other applicable Standards and in cases where the system is being imported into the U.S., it must also comply with CDRH regulations.

In cases where the Buyer is also the end-user of the OEM laser product, the Buyer/end-user must integrate the laser so that it complies with all applicable laser safety standards as set forth above. Table 2-1, Class 4 safety features, summarizes Pulstar p100/150 product features, indicating the type and description of features and whether those features are required by European Union regulations.

### Electromagnetic interference standards

SYNRAD Pulstar p100/150 lasers have demonstrated performance characteristics that have met or exceeded the requirements of EMC Directive 2014/30/EU.

The European Union’s Electromagnetic Compatibility (EMC) Directive, 2014/30/EU, is the sole Directive developed to address electromagnetic interference (EMI) issues in electronic



# Laser Safety

equipment. In particular, the Directive calls out European Norm (EN) documents that define the emission and immunity standards for specific product categories. For p100/150 lasers, EN 61000-6-4:2018 defines radiated and conducted RF emission limits while EN 61000-6-2:2016 defines immunity standards for industrial environments.

Table 2-1 Class 4 safety features.

Feature	Location / Description	Required by:		Available on: OEM p100/150
		CDRH	EN60825-14	
Keyswitch <sup>1</sup>	Rear panel control On/Off/Reset Keyswitch controls power to laser electronics. Key cannot be removed from switch in the "On" position.	Yes	Yes	No
Shutter function	Laser control Functions as a beam attenuator to disable RF driver/laser output when closed.	Yes	Yes	Yes
Shutter indicator	Rear panel indicator (Blue) Illuminates blue to indicate shutter is open.	No	No	Yes
Ready indicator	Rear panel indicator (Yellow) Indicates that laser has power applied and is capable of lasing.	Yes	Yes	Yes
Lase indicator the laser output.	Rear panel indicator (Red) Indicates that Pulstar™ is actively lasing. Lase LED illuminates when the duty cycle of Command signal is long enough to produce	No	No	Yes
Five second delay	Pulstar circuit element Disables RF driver/laser output for five seconds after Keyswitch is turned to "On" or remote reset/start pulse is applied when Keyswitch is in "On" position.	Yes	No	Yes
Power fail lockout <sup>1</sup>	Pulstar circuit element Disables RF driver/laser output if input power is removed then later reapplied (AC power failure or remote interlock actuation) while Keyswitch is in "On" position.	Yes	Yes	No
Remote Interlock	Rear panel connection Disables RF driver/laser output when a remote interlock switch on an equipment door or panel is opened.	Yes	Yes	Yes
Remote Interlock indicator	Rear panel indicator (Green/Red) Illuminates green when Remote Interlock circuitry is closed. Illuminates red when interlock circuitry is open.	No	No	Yes
Over temperature protection	Pulstar circuit element Temperature shutdown occurs if temperature of the laser tube rises above safe operating limits.	No	No	Yes
Temp indicator	Rear panel indicator (Green/Red) Illuminates green when laser temperature is within operating limits, changing to red when thermal limits are exceeded.	No	No	Yes
Warning labels	Pulstar exterior Labels attached to various external housing locations to warn personnel of potential laser hazards.	Yes	Yes	Yes

<sup>1</sup> Not available on p400 OEM lasers

# Laser Safety

When integrating SYNRAD® Pulstar™ p100/150 OEM lasers, the Buyer and/or integrator of the end system is responsible for meeting all applicable Standards to obtain the CE mark. To aid this compliance process, SYNRAD testing program has demonstrated that Pulstar p100/150 lasers comply with the relevant requirements of 2014/30/EU, the Electromagnetic Compatibility Directive, as summarized in Table 2-2 below.

Table 2-2 European Union Directives.

Applicable Standards / Norms

2014/30/EU	Electromagnetic Compatibility Directive
2014/35/EU	Low Voltage Directive
2015/863/EU	RoHS Directive
EN 61010-1:2010	Safety Requirements for Electrical Equipment for Measurement, Control, and Laboratory Use - Part 1: General Requirements
EN 61000-6-4	Radiated Emissions Group 1, Class A
EN 61000-6-4	Conducted Emissions Group 1, Class A
EN 61000-6-2	Electrostatic Discharge Immunity
EN 61000-6-2	RF Electromagnetic Field Immunity
EN 61000-6-2	Electrical Fast Transient/Burst Immunity
EN 61000-6-2	Conducted RF Disturbances Immunity

After a laser or laser processing system has met the requirements of all applicable EU Directives, the product can bear the official compliance mark of the European Union as a Declaration of Conformity.

# Laser Safety



Declaration of Conformity	
in accordance with ISO / IEC 17050-2:2004	
We,	
<b>Manufacturer's Name:</b>	SYNRAD® A Novanta® Company
<b>Manufacturer's Address:</b>	4600 Campus Place Mukilteo, WA 98275 U.S.A.
Hereby declare under our sole responsibility that the following equipment:	
<b>Product Name:</b>	Pulstar p100 Laser
<b>Model Number:</b>	PSP100SB (*OEM)
Conforms to the following Directive(s) and Standard(s):	
<b>Applicable Directive(s):</b>	2014/30/EU          Electromagnetic Compatibility Directive 2014/35/EU          Low Voltage Directive (EU) 2015/863        RoHS Directive
<b>Applicable Standard(s):</b>	
EN 61010-1:2010	Safety Requirements for Electrical Equipment for Measurement, Control, and Laboratory Use - Part 1: General Requirements
EN 61000-6-4:2007	Radiated Emissions, Group 1, Class A
EN 61000-6-4:2007	Conducted Emissions, Group 1, Class A
EN 61000-6-2:2005	Electrostatic Discharge Immunity
EN 61000-6-2:2005	Electromagnetic Field Immunity
EN 61000-6-2:2005	Electrical Fast Transient/Burst Immunity
EN 61000-6-2:2005	Conducted RF Disturbances Immunity
*OEM lasers do not comply with EN 60825-1:2014, <i>Safety of Laser Products</i> . Buyers of OEM laser products are solely responsible for meeting applicable Directives and Standards for CE compliance and marking.	
<b>Corporate Officer:</b>	<b>European Contact:</b>
	Novanta Distribution (USD) GmbH Parkring 57-59 85748 Garching bei München, Germany
Tim Freni, Quality Manager of SYNRAD	
Dated: 7/22/19	
	 MADE IN THE U.S.A. 900-20976-08 Rev D

Figure 2-5 p100 Declaration Document.

# Laser Safety

Declaration of Conformity	
in accordance with ISO / IEC 17050-2:2004	
We,	
<b>Manufacturer's Name:</b>	SYNRAD® A Novanta Company
<b>Manufacturer's Address:</b>	4600 Campus Place Mukilteo, WA 98275 U.S.A.
Hereby declare under our sole responsibility that the following equipment:	
<b>Product Name:</b>	Pulstar p150 Laser
<b>Model Number:</b>	PSP 150SB (OEM*)
Conforms to the following Directive(s) and Standard(s):	
<b>Applicable Directive(s):</b>	2014/30/EU          Electromagnetic Compatibility Directive 2014/35/EC          Low Voltage Directive (EU) 2015/863        RoHS Directive
<b>Applicable Standard(s):</b>	
EN 61010-1:2010	Safety Requirements for Electrical Equipment for Measurement, Control, and Laboratory Use - Part 1: General Requirements
EN 61000-6-4:2007	Radiated Emissions, Group 1, Class A
EN 61000-6-4:2007	Conducted Emissions, Group 1, Class A
EN 61000-6-2:2005	Electrostatic Discharge Immunity
EN 61000-6-2:2005	Electromagnetic Field Immunity
EN 61000-6-2:2005	Electrical Fast Transient/burst Immunity
EN 61000-6-2:2005	Conducted RF Disturbances Immunity
*OEM lasers do not comply with EN 60825-1:2014, <i>Safety of Laser Products</i> . Buyers of OEM laser products are solely responsible for meeting applicable Directives and Standards for CE compliance and marking.	
<b>Corporate Officer:</b>	<b>European Contact:</b>
	Novanta Distribution (USD) GmbH Parkring 57-59 85748 Garching bei München, Germany
Tim Freni, Quality Manager of SYNRAD	
Dated: 7/22/19	
	
	MADE IN THE U.S.A. 900-20976-02 Rev E

Figure 2-6 p150 Declaration Document.

# Technical Reference

## 4

Use information in this chapter as a technical reference for your Pulstar™ p100/150 laser. This chapter contains the following information:

- Technical overview – briefly describes Pulstar’s technology, design RF power supply and basic optical setup.
- Controlling laser power – explains various aspects of Pulstar control signals.
- User I/O connections – describes input/output signals and specifications for the 15-pin User I/O connector.
- DC power cables – provides information about p100/150 DC power cables.
- Integrating Pulstar safety features – describes how to integrate Pulstar p100/150 safety features into your automated control system.
- Pulstar p100/150 general specifications – provides specifications for the Pulstar p100/150 laser.
- Pulstar p100/150 outline and mounting drawings – illustrates laser package outline and mounting dimensions for p100/150 lasers.
- Pulstar p100/150 packaging instructions – illustrates how to package Pulstar p100/150 lasers for shipment.

### **Warning**

**Serious  
personal  
injury**



**Remote interlock faults are not latched on Pulstar™ OEM p100/150 lasers. Clearing the fault condition re-enables the RDY indicator and the laser will fire immediately provided the SHT indicator is lit and a PWM Command signal is applied. Because exposure to 10.6 μm CO<sub>2</sub> laser radiation can inflict severe corneal injuries and seriously burn human tissue, the OEM or System Integrator must ensure that appropriate safeguards are in place to prevent unintended lasing.**

**The use of the Quick Start Plug bypasses the laser’s safety interlock function, potentially exposing personnel in the area to invisible infrared laser radiation. The Quick Start Plug is intended only for initial testing and troubleshooting by qualified personnel. In normal operation, the laser’s Remote Interlock input should be connected to the machine’s safety interlock circuitry.**

# Technical Reference

## Technical Overview

### **Warning**

Serious personal injury



Remote Pressing the F1 function key on the computer keyboard causes WinMark Pro to mark immediately without opening the Launcher dialog!

When using WinMark Pro, the F1 key is designated as a “quick mark” key meaning that the mark is lased immediately. To prevent injury, always ensure that all personnel in the area are wearing the appropriate protective eye-wear and are physically clear of the mark area before beginning a mark session.

Using external tickle pulses may cause the laser to fire!

### **Caution**

Possible Equipment Damage



Operating the laser at **coolant temperatures above 22 °C (72 °F)** may result in decreased performance and/or premature failure of electronic components.

The **Flyer 3D Marking Head's** operating system requires approximately 15–20 seconds to boot up. Repeatedly cycling power during the boot up sequence may cause corruption of Flyer 3D's flash memory and operating system.

**Contamination on the laser's output window (or on any beam delivery optic) can absorb enough energy to damage optical components in the beam path.** Periodically inspect the p100/150's output window and all other beam delivery optics for signs of contaminants and then carefully clean as required. In dirty environments, purge laser optics using filtered air or nitrogen to prevent vapor and debris from accumulating on optical surfaces.

### **Important Note!**

Except for bench testing, we do not recommend using a UC-2000 Controller with the Pulstar OEM p100/150 laser. The automatically-generated tickle signal from the UC-2000 may interfere with the lasers pulsing performance.

# Technical Reference

## Technical Overview

### Technical overview

- Laser design
- Optical setup
- RF power supply

### Laser tube and design

The Pulstar™ p100/150 is a pulsed 100/150-watt laser based on SYNRAD® popular t-Series laser developed using new technology patented by SYNRAD. While the average power of the p100 is similar to the ti100 at 100 W, the p100's peak pulsed output power is typically 400 W and the p150's peak pulsed output power is 600 W. The p150 laser is based on the p100 design, providing 50% more power by increasing the resonator length. The p150 uses a hybrid waveguide/unstable resonator design with a sophisticated beam conditioning system to produce a symmetrical beam. This high peak power in combination with a maximum duty cycle of 37.5% provides high-intensity, short duration pulses that are excellent for minimizing the Heat Affected Zone (HAZ) on many materials.

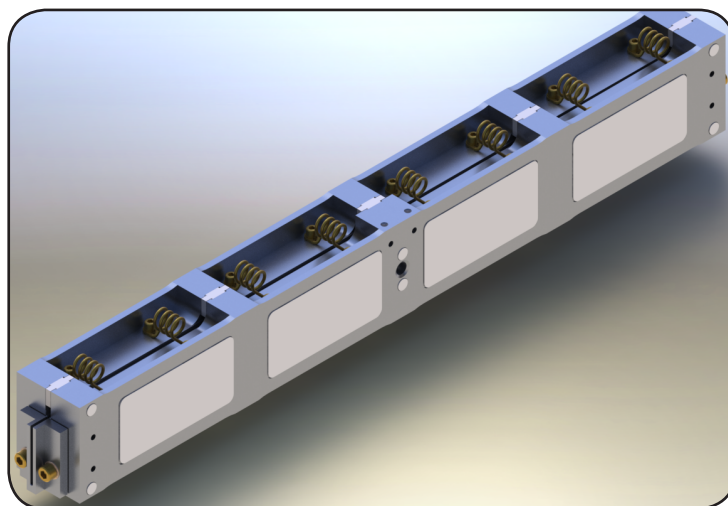

Figure 4-1 Hybrid waveguide/unstable resonator design.

Pulstar's patented "p" technology, include RF components that are integrated within the laser body itself, completely eliminating the need for external RF boxes and cables. The net result is a symmetrical laser beam from a small but powerful laser capable of operating for many years with virtually no maintenance. Based on the same proven technology behind the success of SYNRAD t-Series, the p100/150's peak pulse power takes materials processing a step further by allowing users to cut faster and drill deeper through a variety of materials with minimal heat affect zone and superior cut edge quality. The p150's longer tube design provides excellent power stability, making it ideal for applications that demand the highest levels of consistency and precision. Pulstar's unique extruded aluminum envelope offers excellent heat transfer, long gas life, and low operating costs in contrast to other laser tube technologies. In addition to being the vessel that maintains the lasing environment, the aluminum tube is also the structural platform that integrates the laser's optical, electrical, and cooling components.

# Technical Reference

## Technical Overview

### Heat removal

Heat generated by the plasma is transferred to the bore walls by diffusion. Collected heat is transferred to the water in the cooling tubes by conduction of the electrodes and aluminum envelope. The coolant path is directed through corrosion-resistant copper alloy tubing to regulate laser temperature for maximum stability.

### Optical resonator

The optical resonator, in conjunction with the electrodes and the gas mixture, generates the laser beam. Pulstar™ p100/150 resonators are comprised of three optical elements: a front mirror, a rear mirror, and an output coupler (window). These optical elements are fastened to the tube's exterior and are exposed to its interior through holes in the end caps. O-rings are sandwiched between optical elements and the end cap to form a gas seal and to provide a flexible cushion that allows the slight movement necessary for alignment. All optical elements are aligned and locked into place by factory technicians before the laser is shipped.

The output beam is quite circular as it exits the resonator, transitions to a Gaussian-like mode quality ( $M^2$  factor) of  $< 1.2$ . Beam waist diameter is typically 7.5 mm (p100) – 8 mm (p150) at the output aperture and full-angle divergence due to diffraction is approximately 1.9 milliradians (a 1.9 mrad divergence means that beam diameter increases 1.9 mm over every one meter distance traveled).

### RF and control circuitry

The p100/150 is driven by two compact radio frequency (RF) power supplies mounted internally in the laser chassis. The 48 VDC input voltage is converted into a high-power RF signal using an RF power oscillator. The output from the RF oscillator (nominally at 83.5 MHz) drives the laser directly by exciting carbon dioxide ( $\text{CO}_2$ ) gas in the tube to produce lasing.

Control circuitry built into the laser interrupts operation if any critical parameter is violated. Switches and sensors on the control board monitor various conditions and parameters that, if exceeded, pose a risk of potential damage to the laser. Additionally, laser operation is interrupted in response to the following conditions: (1) the Shutter Open Request input signal is missing; (2) an over temperature condition occurs; (3) the Remote Reset/Start Request input signal is enabled; (4) the Remote Interlock input signal is missing; or (5) any fault is present.

### Beam conditioning

The p100/150 laser incorporates a sophisticated beam conditioning system that cleans up the beam to remove the side lobes and improve beam quality. This is accomplished by turning the laser beam back onto itself after the beam exits the resonator through a 'folding block' that directs the 'beam through' an internal lens system. First the beam is focused through an aperture, a second lens then collimates the beam at an expanded size with lower divergence than the raw beam. Finally, a protective output window on the laser's front plate ensures that the internal beam conditioning optics stay clean. In addition, the beam conditioning system incorporates a beam expander that converts the 2.0 mm diameter resonator beam to a 7.5-8 mm diameter output beam. This larger beam diameter reduces the power density incident on the laser's output window thereby reducing the likelihood of damaged optics.



# Technical Reference

## Technical Overview

### Reflective Phase Retarding Mirror

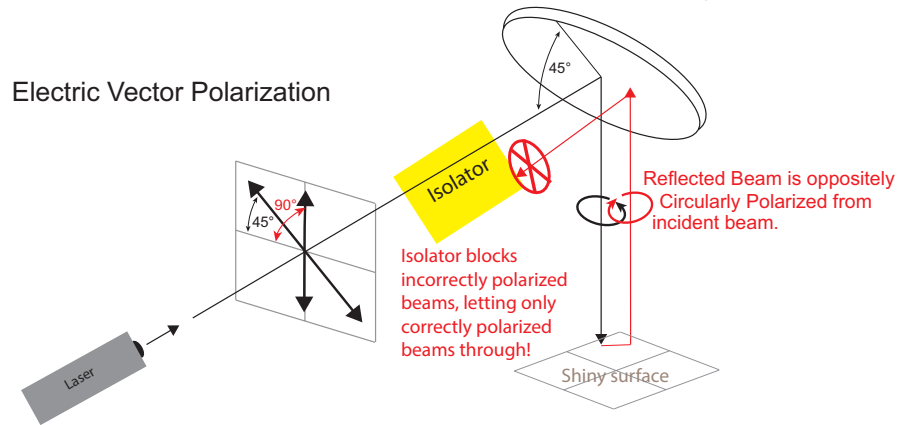

Figure 4-3 Converting 45° linear polarization to circular polarization.

(original Pulstar p150 Operation Manual Version 1 illustration courtesy of II-VI inc.). The Output Beam is Linearly Polarized perpendicular with respect to the Baseplate.

## Polarization

Polarization is important in achieving the best cut quality from a laser and this is usually achieved with linear polarization aligned with the cut direction; however, in most applications where two axes of cut are required, linearly polarized light can lead to differences in cut quality depending on the orientation of the polarization with respect to the cutting direction.

Converting the laser polarization from linear to circularly polarized light gives uniform cut quality in both axes. Circularly polarized light can be generated without significant power loss by using a circular polarizer (also known as a cut quality enhancer or CQE) or a simple phase retarding mirror. For the simplest and most cost-effective solution, a reflective phase retarder, laser polarization must be rotated by 45°.

The p100/p150 is vertically polarized at the faceplate. Rotating the polarization is usually done by mounting the laser at 45° to the horizontal or by using two or more mirrors. A CQE typically incorporates the turning mirrors and phase retarder into one housing.

## Optical setup

After selecting a laser for a CO<sub>2</sub> laser processing system, the two most important elements to consider are: (1) beam delivery optics to transmit the beam to the work area; and (2) focusing optics to focus the beam onto the part or material to be processed. Each element is crucial in the development of a reliable laser-based material processing system and each element should be approached with the same careful attention to detail.

# Technical Reference

## Technical Overview

### **Warning**

Serious  
personal  
injury



The long 10.6  $\mu\text{m}$  wavelength of CO<sub>2</sub> lasers is easily reflected or scattered off metallic surfaces which can lead to personnel injury and/or damage to equipment.

Enclose the processing area in an interlocked enclosure and ensure proper safety glasses are worn.



### **Caution**

Possible  
Equipment  
Damage



Use an **optical isolator** to protect the laser from damage. Failure to do this, may **void the warranty** as equipment damage can occur.

## Optical isolator

An optical isolator is an optical component that allows only the desired linearly polarized light through, preventing unwanted feedback back into the laser. p100/150 lasers do not have internal isolation. If isolation is required, an external third party unit is needed. An optical isolator only works with linearly polarized light and in conjunction with a (quarter wave) phase retarder. Beam delivery manufacturers may package the phase retarder and isolator inside one component commonly marketed as a "Beam Quality Enhancer." Always double check the system with your supplier to ensure the isolator is present.

When laser processing reflective metals like iron, steel or aluminum, problems can occur if CO<sub>2</sub> laser energy is reflected by the workpiece back through the beam-delivery path and into the laser cavity. Back reflection can result in unwanted fluctuations of laser power, or even damage the cavity optics inside the laser. When a reflective material is processed, the use of a back reflection isolator is required.

An optical isolator only works with linearly polarized light and in conjunction with a (quarter wave) phase retarder. The isolator has to be oriented in a very specific rotational orientation relative to the linear polarization. Failure to do so will eliminate the protection of the isolator and incorrectly polarized outgoing lasing energy will not be blocked. Beam delivery manufacturers may package both the phase retarder and the isolator inside one component commonly marketed as a "Beam Quality Enhancer" or BQE. For example, the Haas Laser Technology Part Number [BQE-25-10.6-SYN](#) incorporates both polarization and isolation into one housing that can easily be mounted onto the face plate of the laser. Always double check the system with your supplier to ensure the isolator is present.

# Technical Reference

## Technical Overview

**Note:** Optical components in the beam path must always be aligned to the actual beam path, not the laser faceplate. Because of slight variations in laser construction, the beam path may not always be centered in, or perpendicular to, the aperture in the faceplate.

### Beam delivery

Divergence, or expansion, of the laser beam is important in materials processing since a larger beam entering the focusing optic produces a smaller focused spot.

Expander/collimators are optical devices that reduce beam divergence while at the same time increasing beam diameter by a selectable magnification factor. Adding an expander/collimator substantially reduces beam divergence and any variance in beam diameter caused by the changing optical path length in an XY (“flying optics”) table application. In fixed-length delivery systems where the laser is positioned only one meter away from the focusing optic and a small spot size is required, an expander/collimator is again the best solution to provide the required beam expansion before reaching the focusing optic.

### Focusing optics

When selecting a focusing optic, the primary consideration should be material thickness and any vertical tolerances that occur during final part positioning rather than making a selection based only on minimum spot size. The chosen focal length should create the smallest possible focused spot while providing the depth of field required for the material to be processed.

Optics are fragile and must be handled carefully, preferably by the mounting ring only. Be careful to select optics that are thick enough to withstand the maximum assist gas pressure available for the process. This is especially important in metal cutting applications using high-pressure assist gases.

Cleanliness is another important issue affecting performance; a dirty or scratched lens will under perform and exhibit a vastly shortened lifetime. When the laser application requires air as an assist gas, use only breathing quality air available in cylinders from a welding supply company. Compressed shop air contains minute particles of oil and other contaminants that will damage optical surfaces. If compressed shop air is the only choice available, it must be filtered to the specifications shown in the following table.

### Laser tube

Pulstar™ p100/150 lasers were developed using new technology patented by SYNRAD®. Pulstar’s patented “p” technology, include RF components that are integrated within the laser body itself, completely eliminating the need for external RF boxes and cables. The net result is a symmetrical laser beam from a small but powerful laser capable of operating for many years with virtually no maintenance. Pulstar’s unique extruded aluminum envelope offers excellent heat transfer, long gas life, and low operating costs in contrast to other laser tube technologies. Besides being the vessel that maintains the lasing environment, the aluminum tube is also the structural platform that integrates the laser’s optical, electrical, and cooling components.

# Technical Reference

## Technical Overview

### p100/150 Technology

The p100/150's peak pulse power takes materials processing a step further by allowing users to cut faster and drill deeper through a variety of materials, with minimal heat affect zone and superior cut edge quality.

### Cooling

Heat generated by excited CO<sub>2</sub> molecules is transferred to the bore walls by diffusion. Collected heat is transferred to the water in the cooling tubes by conduction of the electrodes and aluminum envelope. The coolant path is directed through corrosion-resistant copper alloy tubing to regulate temperature for maximum stability. Operating the laser at coolant temperatures above 22 °C may result in decreased performance and/or premature failure of electronic components.

### Cooling guidelines

SYNRAD® recommends that the laser's cooling fluid contain at least 90% water (distilled or tap) by volume. In closed loop systems, use a corrosion inhibitor such as Optishield® Plus or equivalent. Avoid glycol-based additives as they reduce the coolant's capacity and high concentrations may affect power stability. For SYNRAD lasers, the minimum coolant set-point is 18 °C (64) °F so glycol is not necessary unless the chiller is subjected to freezing temperatures.

- In applications where biocides containing chlorides are used, concentrations should not exceed 25 parts per million (PPM).
- Maintain a coolant pH level above 7.0. We recommend the installation of a filter on the chiller's return line, especially in areas where water hardness is a problem.

### Coolant temperature

Set a chiller temperature set-point between 18–22 °C (64–72 °F). The set-point temperature **MUST** be maintained above the dew point temperature. Operating the laser with a coolant temperature below the dew point of the surrounding air may cause condensation to occur that will damage the laser.

### Condensation

Inspect the laser daily for signs of water condensation during operation. Condensation causes damage to electrical and optical components.

Do **NOT** operate the laser in a condensing environment—the laser will be damaged! Refer to the Pulstar p100/150 Technical Reference section in this manual for additional steps you can take to prevent condensation damage.

# Technical Reference

## Technical Overview

Table 4.1a Dew point temperatures in Fahrenheit.

Dew Point Table °F

Air Temp (°F)	Relative Humidity (%)															
	20%	25%	30%	35%	40%	45%	50%	55%	60%	65%	70%	75%	80%	85%	90%	95%
60 °F	-	-	-	32	36	39	41	44	46	48	50	52	54	55	57	59
65 °F	-	-	33	37	40	43	46	48	51	53	55	57	59	60	62	64
70 °F	-	33	37	41	45	48	51	53	56	58	60	62	64	65	67	69
75 °F	-	37	42	46	49	52	55	58	60	62	65	67	68	70	72	73
80 °F	35	41	46	50	54	57	60	62	65	67	69	71	73	75	77	78
85 °F	40	45	50	54	58	61	64	67	70	72	74	76	78	80	82	83
90 °F	44	50	54	59	62	66	69	72	74	77	79	81	83	85	87	88
95 °F	48	54	59	63	67	70	73	76	79	81	84	86	88	90	92	93
100 °F	52	58	63	68	71	75	78	81	84	86	88	91	93	95	97	98

# Technical Reference

## Technical Overview

Table 4.1b Dew point temperatures in Celsius or Centigrade.

**Dew Point Table °C**

Air Temp (°C)	Relative Humidity (%)															
	20%	25%	30%	35%	40%	45%	50%	55%	60%	65%	70%	75%	80%	85%	90%	95%
16 °C	-	-	-	0	2	4	5	7	8	9	10	11	12	13	14	15
18 °C	-	-	1	3	4	6	8	9	11	12	13	14	15	16	17	18
21 °C	-	1	3	5	7	9	11	12	13	14	16	17	18	18	19	21
24 °C	-	3	6	8	9	11	13	14	16	17	18	19	20	21	22	23
27 °C	2	5	8	10	12	14	16	17	18	19	21	22	23	24	25	26
29 °C	4	7	10	12	14	16	18	19	21	22	23	24	26	27	28	28
32 °C	7	10	12	15	17	19	21	22	23	25	26	27	28	29	31	31
35 °C	9	12	15	17	19	21	23	24	26	27	29	30	31	32	33	34
38 °C	11	14	17	20	22	24	26	27	29	30	31	33	34	35	36	37

# Technical Reference

## Technical Overview

### Dew point

The dew point table provides dew point temperatures for a range of air temperature and relative humidity values. Remember that the laser's coolant temperature must be set above the dew point temperatures given in the chart, but should not exceed 22 °C (72 °F).

To use the table, look down the Air Temp column and locate an air temperature in Fahrenheit or Celsius (°C values are shown in parentheses) that corresponds to the air temperature in the area where your laser is operating. Follow this row across until you reach a column matching the relative humidity in your location. The value at the intersection of the Air Temp and Relative Humidity columns is the Dew Point temperature in °F (or °C).

The chiller's temperature set-point must be set above the dew point temperature. For example, if the air temperature is 85 °F (29 °C) and the relative humidity is 60%, then the dew point temperature is 70 °F (21 °C). Adjust the chiller's temperature set-point to 72 °F (22 °C) to prevent condensation from forming inside the laser or RF power supply.

### Temperature set-point

Choosing the correct coolant temperature is important to the proper operation and longevity of your laser. When coolant temperature is lower than the dew point (the temperature at which moisture condenses out of the surrounding air), condensation forms inside the laser housing leading to failure of electronics and damage to optical surfaces.

The greatest risk of condensation damage occurs when the laser is in a high heat/high humidity environment and the chiller's coolant temperature is colder than the dew point of the surrounding air or when the system is shut down, but coolant continues to flow through the laser for extended periods of time.

The chiller's temperature set-point must always be set above the dew point temperature. In cases where this is not possible within the specified coolant temperature range of 18 °C to 22 °C (64 °F to 72 °F), then the following steps **MUST** be taken to reduce the risk of condensation damage.

- Stop coolant flow when the laser is shut down.
- Increase coolant flow by an additional 1.0 GPM. Do not exceed a coolant pressure of 60 PSI (4.1 bar).

Table 4.2 Gas purge specifications.

Purge Gas	Specification
Nitrogen	High Purity Grade 99.9500% purity or better
Air	Breathing Grade 99.9996% purity or better
Air	Compressed 99.9950% purity or better, water-free; oil filtered to 5 mg/m <sup>3</sup> or better; particulate filtered to < 1.0 micron; dried to lower dew point below coolant temperature setpoint

# Technical Reference

## Technical Overview

### Gas Purge port

Apply a gas purge pressure between 0.14–0.34 bar (2–5 PSI) or a flow rate of 849–1699 liters/hour (30–60 SCFH). Do not exceed a pressure of 0.34 bar (5 PSI). Use only nitrogen or CDA (clean dry air) as a purge gas. Do not use any other gas as this could damage the laser.

- Air-condition the room or the enclosure containing the laser.
- Install a dehumidifier to reduce the humidity of the enclosure containing the laser.
- Purge the laser - See Gas Purge Specifications.

### Flow rate

Set coolant flow according to the following table. Ensure that coolant pressure does not exceed 60 PSI (4.1 bar).

Table 4.3 p100/150 water flow rate.

Laser Type	Minimum Water Flow Rate	Recommended Water Flow Rate
p100/150	1.5 GPM (5.7 LPM)	2 GPM (7.58 LPM)

Table 4.4 Assist gas purity specifications.

Assist Gas	Typical Purpose	Specification
Air	Cutting/Drilling	Breathing Grade $\geq 99.9996\%$ purity; filtered to ISO Class 1 particulate level
Air	Cutting/Drilling	Compressed Instrument-grade air filtered and dried to ISO 8573-1:2010 Class 1, 2, 1 ( $\leq 10$ 1.0–5.0 $\mu\text{m}$ particles/ $\text{m}^3$ ; $\leq -40$ °F ( $-40$ °C) dew point; $\leq 0.01$ mg/ $\text{m}^3$ oil vapor)
Argon	Welding	High Purity Grade $\geq 99.998\%$ purity; filtered to ISO Class 1 particulate level
Helium	Welding	High Purity Grade $\geq 99.997\%$ purity; filtered to ISO Class 1 particulate level
Nitrogen	Cutting/Drilling	High Purity Grade $\geq 99.9500\%$ purity; filtered to ISO Class 1 particulate level
Oxygen	Cutting/Drilling	Ultra Pure Grade $\geq 99.9998\%$ purity; filtered to ISO Class 1 particulate level

### RF power supply

Pulstar™ p100/150 lasers are driven by two compact RF modules mounted internally in the laser chassis. Each RF module converts 48 VDC input power into a radio frequency (RF) signal



# Technical Reference

## Technical Overview

that is then amplified and routed to its corresponding electrode structure in the laser tube where it excites the gas mixture in the tube to produce lasing.

Control circuitry built into the laser interrupts operation if any critical parameter is violated. Switches and sensors on the control board monitor various conditions and parameters that, if exceeded, pose a risk of potential damage to the laser. Additionally, laser operation is interrupted in response to the following conditions: (1) the EM shutter is closed; (2) the Shutter Open Request input signal is missing; (3) an over temperature or low coolant flow condition occurs; (4) the Remote Reset/Start Request input signal is enabled; (5) the Remote Interlock input signal is missing; or (6) any fault is present.

# Technical Reference

## Controlling Laser Power

The Controlling laser power section includes subsections:

- Control signals
- Operating modes

### Control signals

Pulstar™'s five user outputs correspond to the status functions described in the following Output Signal Section. These outputs are optoisolated solid-state relays that allow for high-side or low-side switching. The shared connection, Output Common, is separate from the laser's chassis ground to allow high-side or low-side switching and to isolate control signals for optimum EMI performance. The optically-isolated outputs are useful for sending laser status to a Programmable Logic Controller (PLC) or computerized control system. Each of the five outputs: Pin 6, 7, 8, 13, and 14 can source 50 mA at  $\pm 24$  VDC maximum for a total load of 250 mA. When controlling larger loads, use these outputs to drive a control relay.

**Note:** Because all Pulstar OEM p100/150 lasers incorporate a built-in tickle generator (2-6 $\mu$ s pulses at 5kHz), there is no need to supply external tickle pulses. The application of external tickle pulses may affect the p100/150's pulsing performance.

### Tickle pulse

Tickle pulses pre-ionize the laser gas to just below the lasing threshold so that a further increase in pulse width adds enough energy to the plasma to cause laser emission. Tickle pulses cause the laser to respond predictably and almost instantaneously to PWM Command signals, even when there is considerable delay (laser off time) between applied Command signals. All Pulstar p100/150 lasers incorporate a built-in tickle generator, freeing customers from the need to supply external tickle pulses between lasing commands.

#### **Warning!**

**Serious  
Personal  
Injury**



**Caution! Lasing can occur when the READY light is on regardless of RED LED status.**

**Because of phase differences, external tickle pulses may combine with the internally-generated tickle signal causing the LASE LED to flicker during the transition from tickle to lasing. Laser output may occur if the LASE LED flickers.**

Internal circuitry monitors the incoming PWM signal and determines the amount of time the laser was on (lasing) during the last 200 microsecond ( $\mu$ s) interval. If the laser's on time was greater than the preset tickle value, then no tickle pulse is generated because the PWM signal was sufficient to maintain a plasma state. If no PWM signal was applied during the 200- $\mu$ s measurement period (or was shorter than the preset tickle value), internal circuitry generates a tickle pulse such that the laser always receives a pre-set amount of RF drive averaged over any 200- $\mu$ s interval.

# Technical Reference

## Controlling Laser Power

### Operation modes

#### Pulse Width Modulation (PWM)

Pulse Width Modulation, or PWM, controls laser power by varying the duty cycle of Pulstar™'s RF amplifiers, which in turn control the time-averaged RF power applied to the laser. The percentage of optical output increases as duty cycle increases (at a constant PWM frequency) or as PWM frequency decreases (at a constant duty cycle).

Pulstar p100/150 lasers are designed to operate at Command signal base frequencies up to 100 kHz (p100)/200 kHz (p150); however, the choice of PWM frequency depends on the user's specific application. When considering Command frequencies at 5 kHz or below, please review Marking/engraving operation later in this section. For high-speed motion applications that cannot tolerate any ripple in the optical beam response but still need adjustable power levels, we recommend the use of higher PWM frequencies, up to 100 kHz (p100)/200 kHz (p150) maximum.

#### **Warning!**

**Serious**

**Persona**

**Injury**



**Always use shielded cable when connecting to your PWM Command signal source to PWM Input/PWM Return inputs.**

**In electrically-noisy environments, long lengths of unshielded wire act like an antenna and may generate enough voltage to trigger un-commanded lasing.**

#### Command signal

The modulated Command signal applied between Pin 9, PWM Input, and Pin 1, PWM Return, of the User I/O connector on the Pulstar p100/150 laser has two parameters: pulse frequency, and PWM duty cycle. By changing these two parameters, you can command the beam to perform a variety of marking, cutting, welding, or drilling operations.

Signal amplitude, is either logic low—corresponding to laser beam off, or logic high—corresponding to beam on. The laser off voltage, typically 0 V, can range from 0.0 V to +0.8 VDC while the laser on voltage, typically 5 V, can range from +3.5 V to +6.7 VDC. Please refer to the specifications Tables 5.2-5.3. The two parameters below better explains the specification limits.

Pulse frequency, the first command signal parameter, is the repetition rate of the PWM input signal. The p100/150's pulse frequency can range from a single-shot up to a maximum frequency of 100 kHz (p100)/200 kHz (p150) with pulse widths up to 600  $\mu$ s.

The second command signal parameter, PWM duty cycle, is the percentage of the period that the Command signal is high. For example, if the Command signal's amplitude (at 5 kHz) is high for 75  $\mu$ s and low for 125  $\mu$ s, it has a 37.5% duty cycle. The duty cycle is also 37.5% if the amplitude (at 1 kHz) is high for 375  $\mu$ s and low for 625  $\mu$ s. As shown in the following figures, 5.6-5.14 at higher frequencies (625 Hz) and high duty cycles (37.5%).

# Technical Reference

## Controlling Laser Power

**Important Note:** When the Pulstar p100/150 pulsed laser PWM > 37.5% duty cycle, the laser does not stop, it only is limited to 37.5% maximum duty cycle. If this occurs, the status LEDs/outputs will indicate a 'no strike fault' condition (see Maintenance and Troubleshooting chapter for further information).

As the duty cycle is increased from 20% to 37.5% (as seen in the figure below), p100/150 output still reaches full depth of modulation; however, maximum power is lower than peak power because of the loss of tube gain due to plasma heating. As PWM frequency increases beyond 1 kHz (at maximum duty cycle), peak power begins to decrease and average power output becomes a larger factor in materials processing than peak power output.

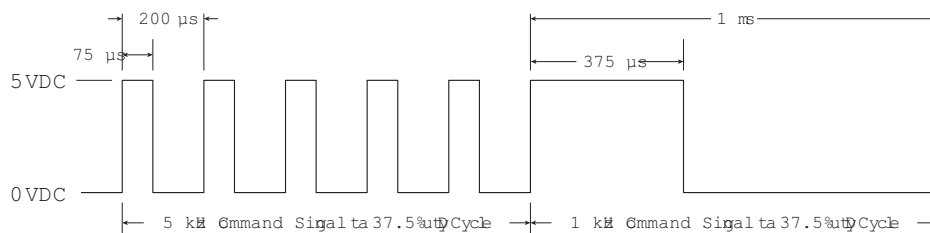

Figure 4-5 PWM command signal wave form.

Laser power is nominally linearly proportional to the PWM duty cycle. As PWM frequency increases, it will take a larger duty cycle before the laser starts to fire. However, at high PWM frequencies there is a significant threshold effect as shown in the figure below.

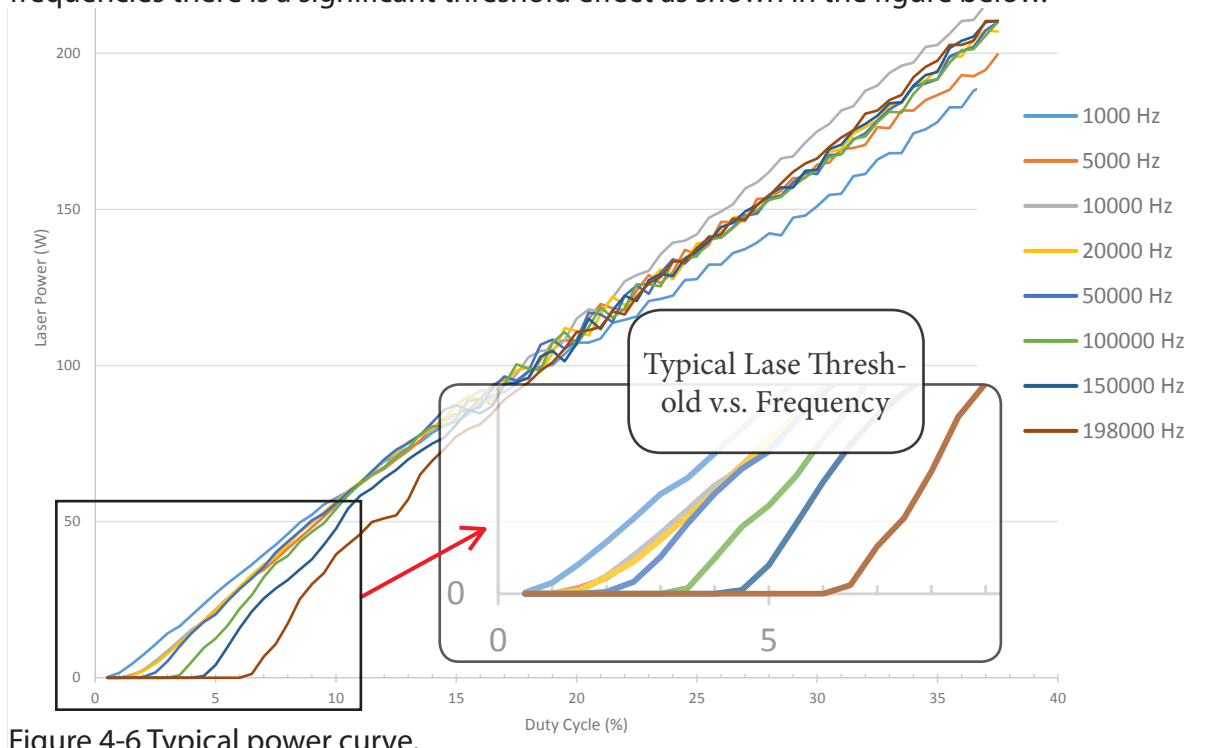

Figure 4-6 Typical power curve.

# Technical Reference

## Controlling Laser Power

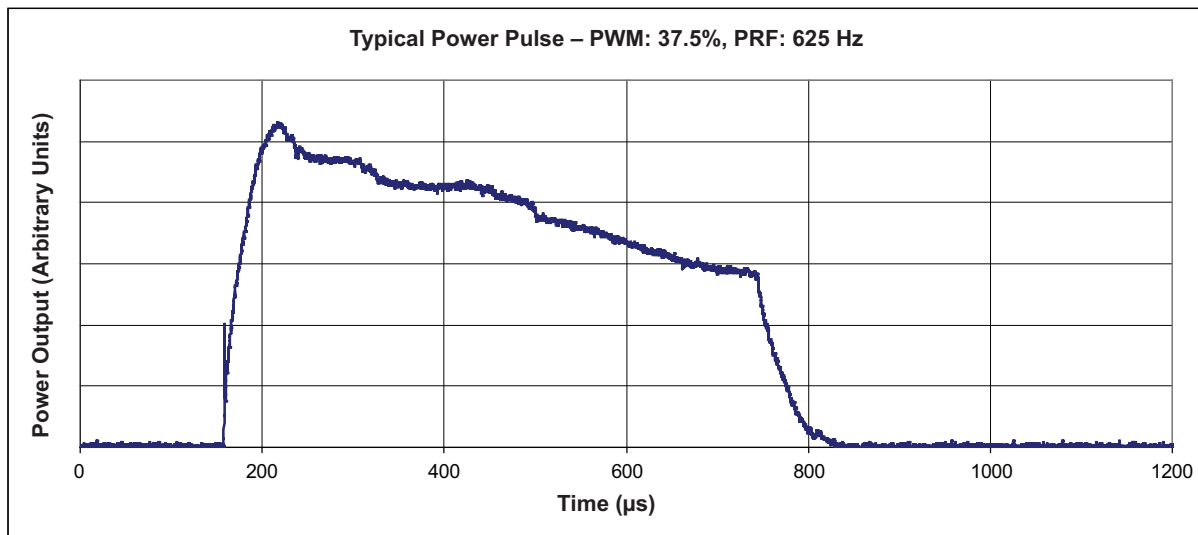

Figure 4-7 Pulstar™ p100 pulse profile – 37.5% duty cycle at 625 Hz.

The figure above and below illustrates the p100/150 laser delivering full peak power (approximately 400W (p100) and 600W (p150) and peak pulse energy (at the maximum 600 µs pulse width) with 100% depth of modulation. The leading edge of the output energy pulse reaches full peak power and then drops off slightly as the tube gain diminishes due to plasma heating.

# Technical Reference

## Controlling Laser Power

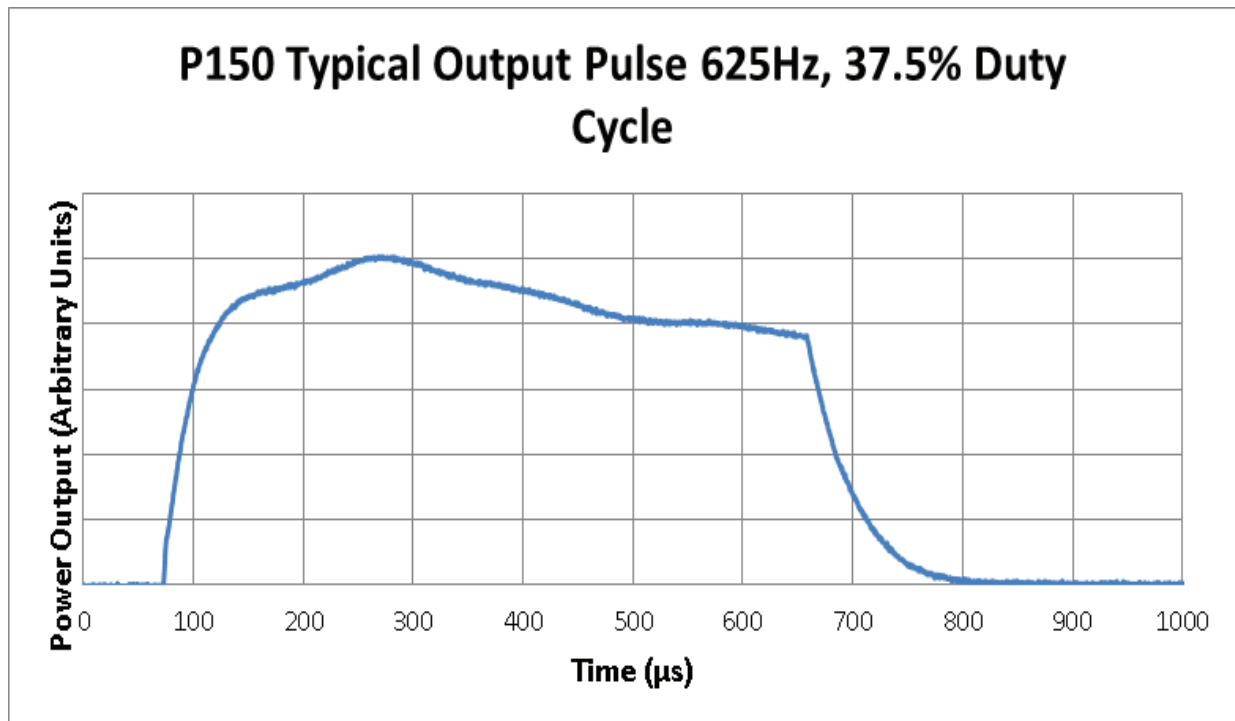

Figure 4-8 Pulstar p150 pulse profile – 37.5% duty cycle at 625 Hz.

These figures illustrate representative temporal pulse profiles of the OEM p100/150 laser at various PWM duty cycles and pulse repetition frequencies (PRF).

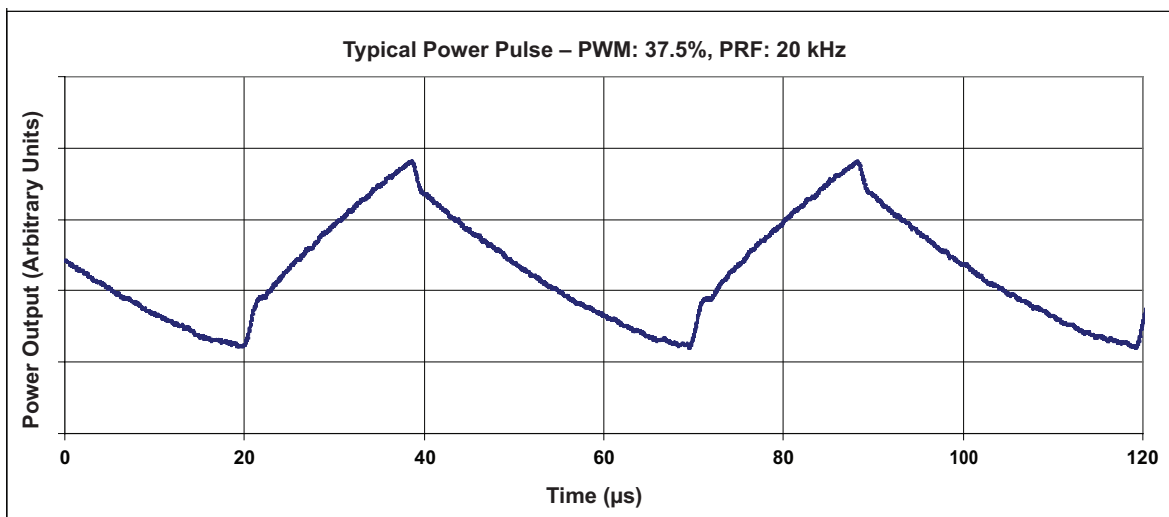

Figure 4-9 Pulstar p100 pulse profile – 37.5% duty cycle at 20 kHz.

# Technical Reference

## Controlling Laser Power

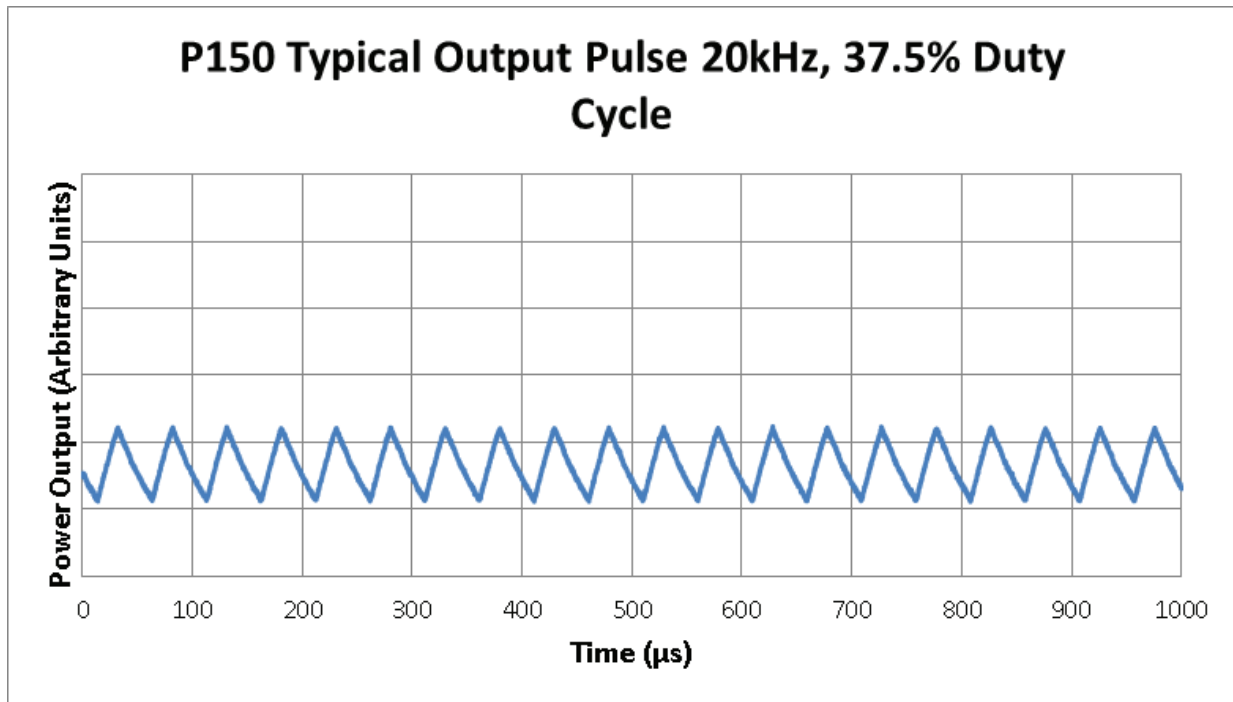

Figure 4-10 Pulstar™ p150 pulse profile – 37.5% duty cycle at 20 kHz.

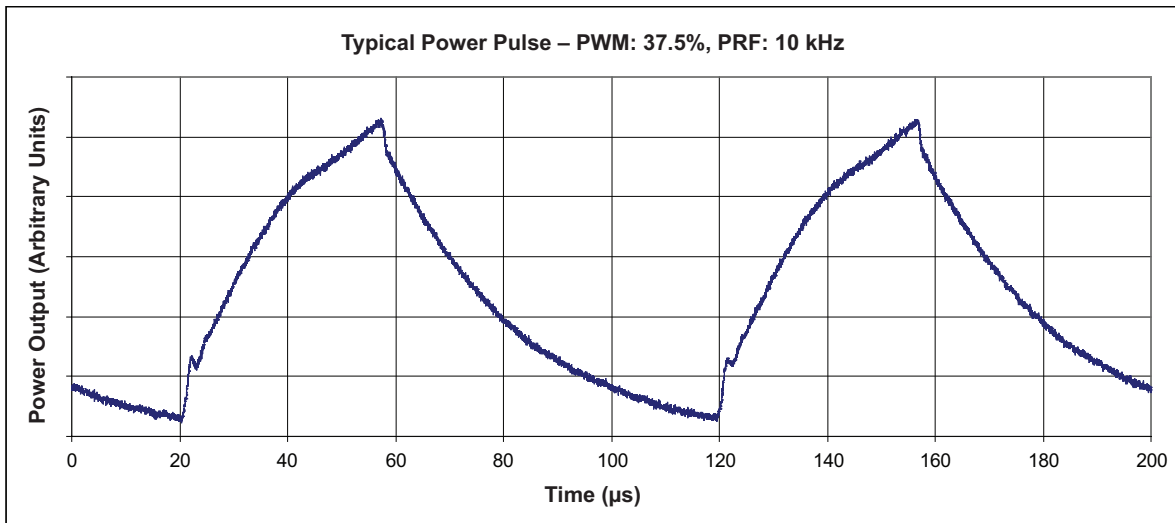

Figure 4-11 Pulstar p100 pulse profile – 37.5% duty cycle at 10 kHz.

# Technical Reference

## Controlling Laser Power

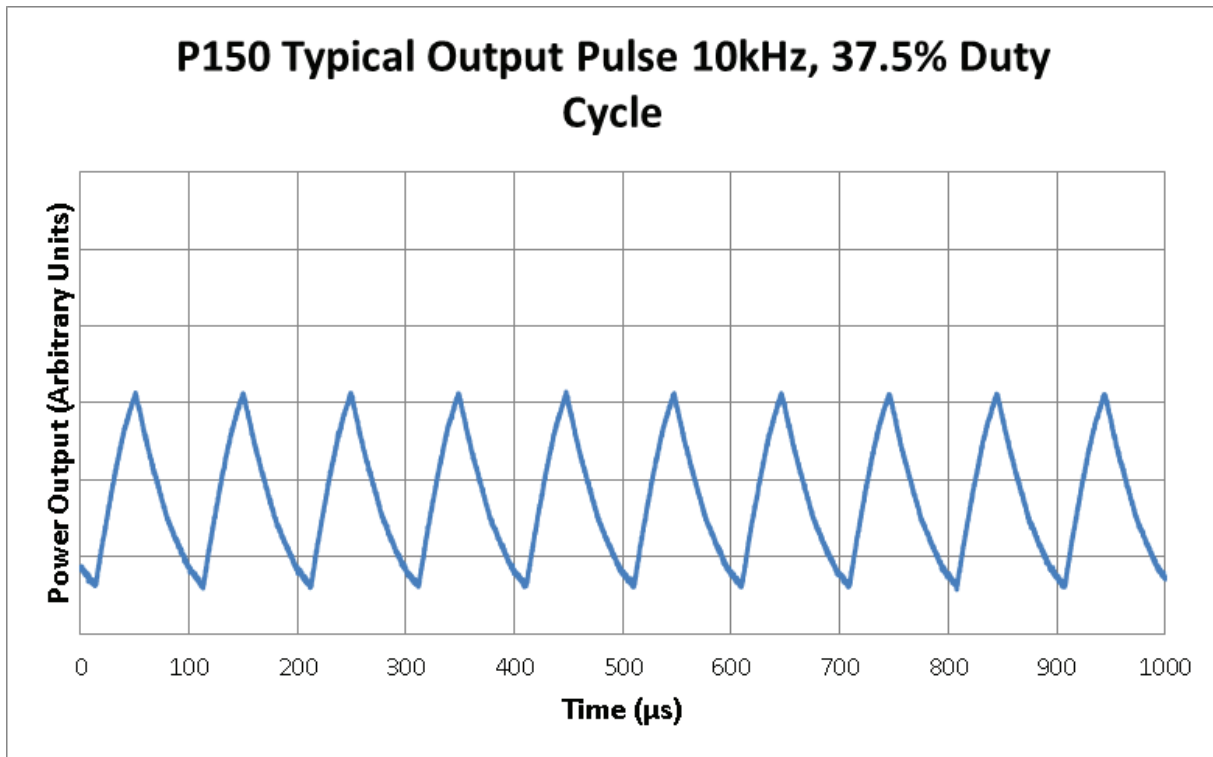

Figure 4-12 Pulstar p150 pulse profile – 37.5% duty cycle at 10 kHz.

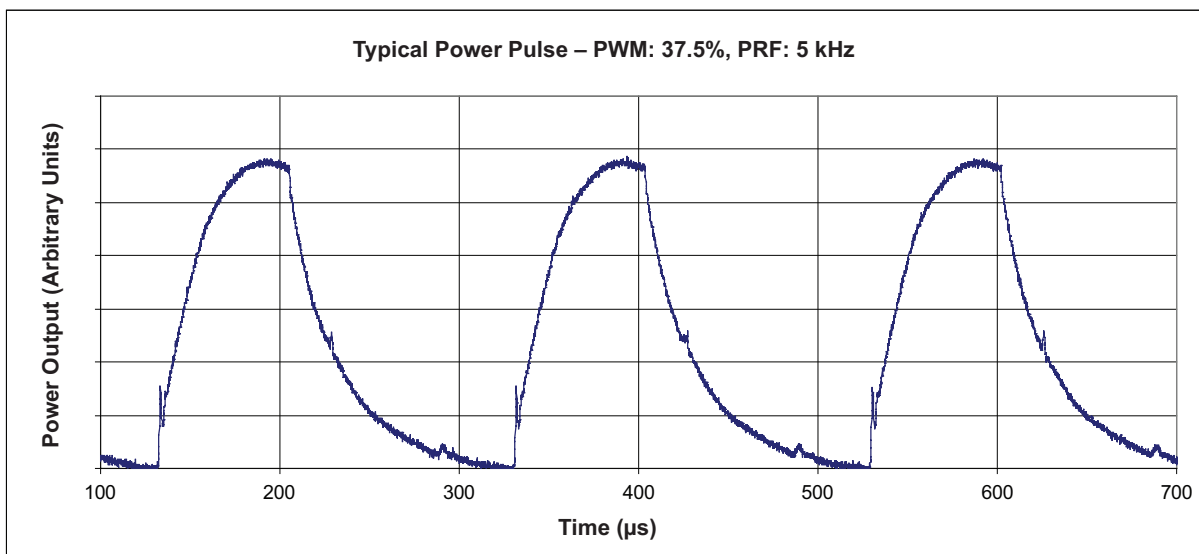

Figure 4-13 Pulstar p100 pulse profile – 37.5% duty cycle at 5 kHz.



# Technical Reference

## Controlling Laser Power

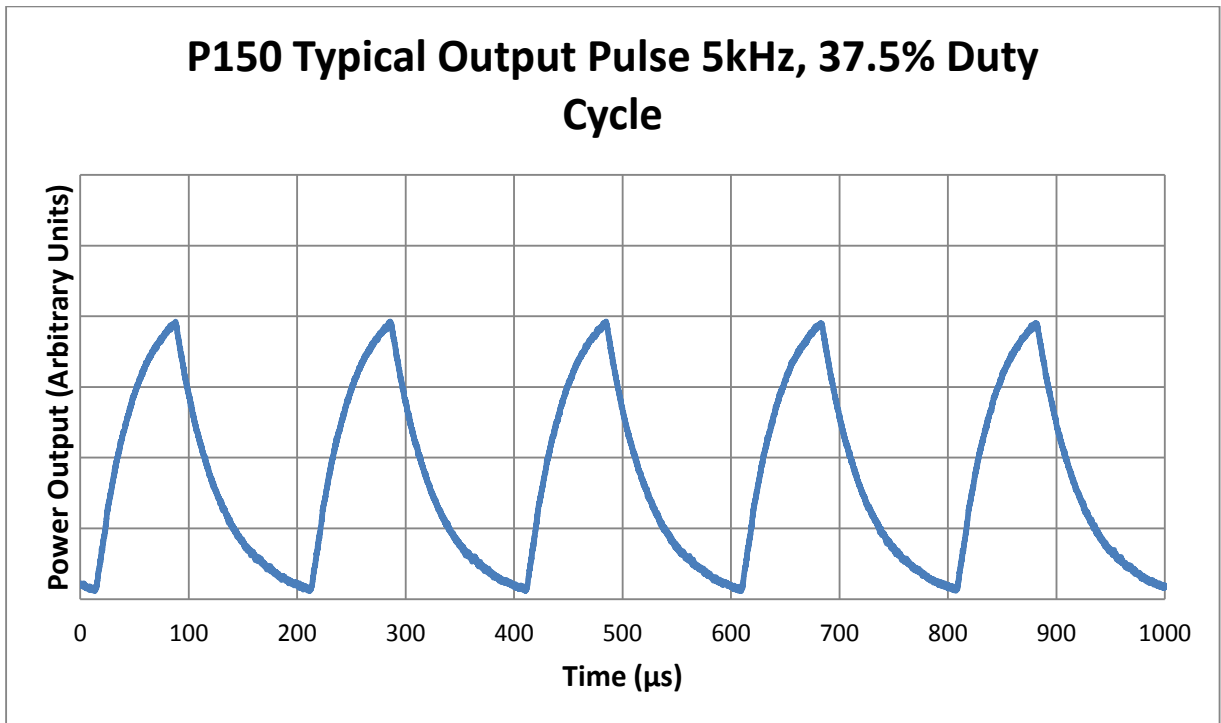

Figure 5-14 Pulstar p150 pulse profile – 37.5% duty cycle at 5 kHz.

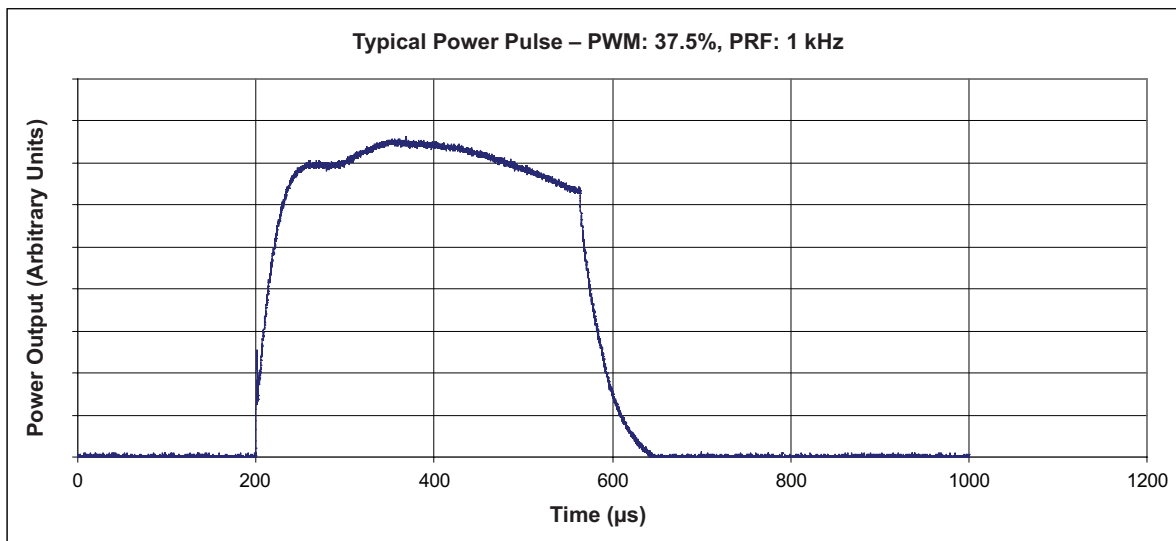

Figure 5-15 Pulstar p100 pulse profile – 37.5% duty cycle at 1 kHz.

# Technical Reference

## Controlling Laser Power

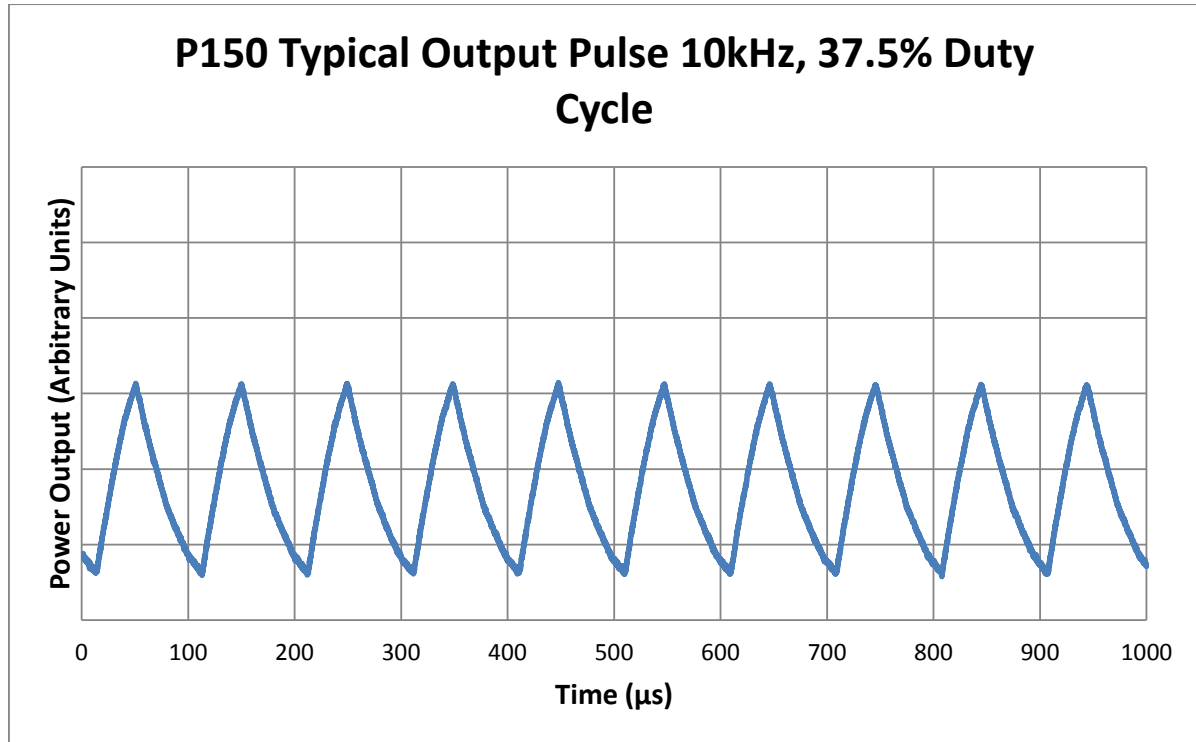

Figure 4-16 Pulstar p150 pulse profile – 37.5% duty cycle at 1 kHz.

Table 4.5 PWM Command signal specifications.

Laser State	Minimum	Nominal	Maximum
Laser Off	0.0 VDC	0.0 VDC	+0.8 VDC
Laser On	+3.5 VDC (3 mA)	+5.0 VDC	+6.7 VDC (10 mA), continuous
Frequency Range	0 Hz (DC)	5 kHz	100 kHz (p100), 200 kHz (p150)
Typical Duty Cycle	1%	— —	37.5%

# Technical Reference

## Controlling Laser Power

### **Warning!**

**Serious**

**Persona**

**Injury**



Always use shielded cable when connecting your PWM Command signal source to PWM Input/PWM Return inputs.

In electrically-noisy environments, long lengths of unshielded wire act like an antenna and may generate enough voltage to trigger uncommanded lasing.

### Marking/engraving operation

When the delay between the end of one PWM Command signal pulse and the beginning of the next PWM pulse exceeds 200 microseconds (less than or equal to 5 kHz), Pulstar's on-board tickle generator sends a tickle pulse to maintain plasma ionization in the tube. Because the on-board tickle generator can not anticipate when the next PWM Command pulse will arrive; the tickle pulse (which typically lasts for 2–6  $\mu$ s depending on the laser) can effectively merge with a PWM signal that follows closely afterwards. When the PWM pulse that follows is short, causing the tickle pulse to become a significant fraction of the PWM pulse duration, then the tickle pulse effectively substantially increases the length of the PWM pulse it has merged with. For subtle marking applications on sensitive, low threshold materials this lengthened PWM pulse may affect mark quality.

While this situation can occur when using PWM Command signal frequencies of 5 kHz and less, it is important to note that it isn't the Command signal frequency itself that is the determining factor but rather this behavior happens only when the off time between PWM pulses exceeds 200 microseconds.

# Technical Reference

## User I/O Connections

The User I/O+ connections section includes subsections:

- User I/O connection summary
- Input/output signals
- Sample I/O circuits

The PWM Command signal and all input/output (I/O) control signals are connected to the User I/O port. Please refer to the figure below for the 15 pin female D-type sub-miniature connector on the p100/150's rear panel. The figure below illustrates the pin arrangement of the User I/O connector.

### Caution

Possible  
Equipment  
Damage



Turn off DC power before installing or removing any plug or cable from the User I/O connector. Ensure that user connections are made to the appropriate pins and that the appropriate signal levels are applied. Failure to do so may damage the laser.

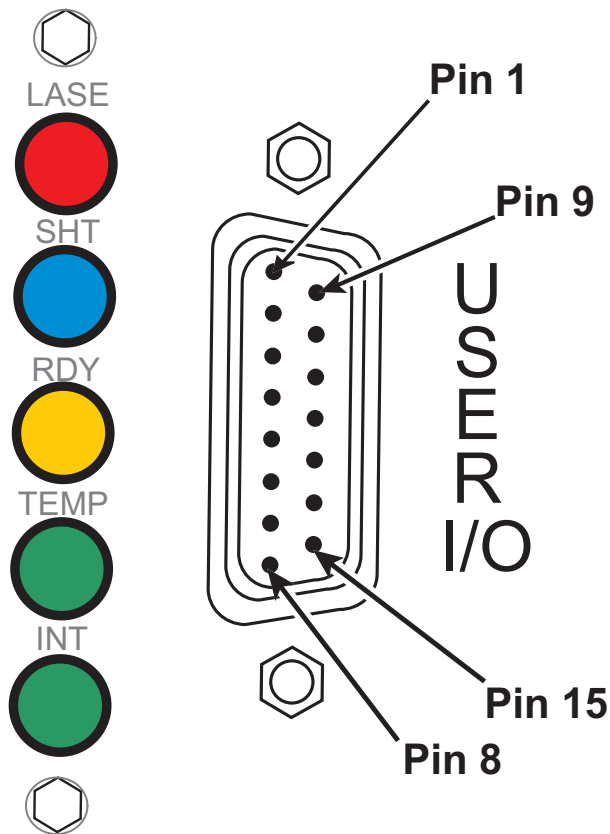

Figure 4-17 User I/O connector pinouts.

# Technical Reference

## User I/O Connections

### User I/O connection summary

The table below provides a quick reference summary to Pulstar™ p100/150 User I/O connections.

Table 4.6 User I/O pin descriptions.

Pin	Function	Description
1	PWM Return	Use this input pin as the return side of the PWM Command signal.
2	Remote Reset/Start Request input	Apply a positive or negative voltage ( $\pm 5$ –24 VDC) with respect to Pin 11, Input Common, to reset or remote keyswitch the laser. The laser remains disabled while voltage is applied. Removing voltage from the Remote Reset/Start Request input causes the laser's RDY indicator to illuminate and begins a five-second countdown after which lasing is enabled.
<b>Note:</b> When connecting field wiring to the Remote Reset/Start Request input, use twisted pair and/or shielded cabling. Refer to SYNRAD® Technical Bulletin #021 for details.		
3	Remote Interlock input	Apply a positive or negative voltage ( $\pm 5$ –24 VDC) with respect to Pin 11, Input Common, to enable lasing. If your system does not use a remote interlock, this pin must be connected to a voltage source in the range of $\pm 5$ –24 VDC. Refer to the prior figure showing how the Remote Interlock input is factory-jumpered on the Quick Start Plug.
4	+ 5 VDC Auxiliary Power	This connection provides +5 VDC for driving external inputs or outputs. The +5 VDC Auxiliary Power output can source up to 0.5 A and is protected by a 0.5 A self-resetting fuse. The return (ground) path must be through Pin 12, Auxiliary DC Power Ground.
5	+ 24 VDC Auxiliary Power	This connection provides +24 VDC for driving external inputs or outputs. The +24 VDC Auxiliary Power output can source up to 0.5 A and is protected by a 0.5 A self-resetting fuse. The return (ground) path must be through Pin 12, Auxiliary DC Power Ground.
6	Laser Active output	This bi-directional switched output is internally connected to Pin 13, Output Common, when the laser is actively lasing (LASE indicator illuminated red). This output is open (high impedance) when no beam is being emitted (LASE indicator Off).
7	Fault Detected output	This bi-directional switched output is internally connected to Pin 13, Output Common, when (1) laser temperature is above safe operating limits (TMP LED illuminated red) or (2) a No-Strike condition has occurred (blue SHT indicator is flashing). The output is open (high impedance) when laser operation is within limits (TMP LED green and SHT LED blue).

# Technical Reference

## User I/O Connections

Pin	Function	Description
8	Laser Ready output	<p>This bi-directional switched output is internally connected to Pin 13, Output Common, when the laser is enabled (RDY LED illuminated yellow), indicating that lasing will occur when a PWM Command signal is applied to Pin 9 and Pin 1. When this output is initially switched closed, there is a five-second delay during which lasing is inhibited. This output is open (high impedance) when the laser is disabled (RDY indicator Off).</p>
9	PWM Input	<p>Connect your PWM Command signal (+5 VDC, 5 kHz nominal, 100 kHz max, pulse width modulated) to this input pin to control laser output power. Refer back to Controlling laser power for further information on laser control signals.</p>
10	Shutter Open Request input	<p>Apply a positive or negative voltage (<math>\pm 5</math>–24 VDC) with respect to Pin 11, Input Common, to enable the laser. This input is also used to actuate the optional EM shutter if your laser is so equipped. If your system does not supply a Shutter Open Request signal, this pin must be connected to a voltage source in the range of <math>\pm 5</math>–24 VDC. Refer to the prior figure for a diagram showing how the Shutter Open Request input is factory-jumpered on the Quick Start Plug. The shutter will not activate until a voltage is also applied to the Remote Interlock input (INT LED illuminated green and RDY LED On).</p>
11	Input Common	<p>Use this input pin to connect return lines for Remote Interlock, Shutter Open Request, and Remote Reset/Start Request lines.</p>
12	Auxiliary DC Power Ground	<p>This connection provides a ground (earth) connection for +5 and +24 VDC auxiliary power outputs. This pin is the only User I/O pin that is connected to chassis ground. Do not use this pin for grounding if DC power to external I/O circuits is supplied from an external customer-supplied DC power source.</p>
13	Output Common	<p>Use this pin to complete the return path for output connections (Pin 6, 7, 8, 14, or 15). The Output Common line is protected by a 0.3 A self-resetting fuse.</p>
14	Shutter Open output	<p>This bi-directional switched output is internally connected to Pin 13, Output Common, when Remote Interlock <u>and</u> Shutter Open Request signals are present (RDY indicator illuminated yellow and SHT indicator blue) to indicate that the shutter is open and lasing is enabled. This output is open (high impedance) when the laser is disabled (SHT indicator Off).</p>
15	Interlock Open output	<p>This bi-directional switched output is internally connected to Pin 13, Output Common, when remote interlock circuitry is open (INT indicator illuminated red), indicating that lasing is disabled. The output is open (high impedance) when lasing is enabled (INT indicator green).</p>

# Technical Reference

## User I/O Connections

### Input/output signals

The Pulstar p100/150's input/output signals are divided into three categories: auxiliary DC power, input signals, and output signals. Signals in each category are fully described in the following sections.

### Auxiliary DC power

Pulstar's User I/O connector provides auxiliary DC power for driving external inputs or outputs connected to the User I/O port. Pin 4, +5 VDC Auxiliary Power, and Pin 5, +24 VDC Auxiliary Power, are protected by self-resetting fuses rated at 0.5 A. Pin 12, Auxiliary DC Power Ground, is connected to chassis ground while all other User I/O pins are floating with respect to chassis ground. The figure below illustrates Pulstar's internal DC supply wiring.

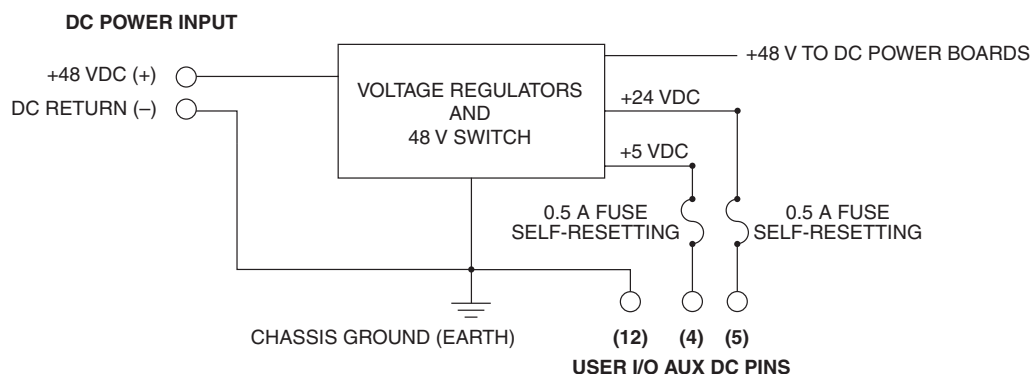

Figure 4-18 Auxiliary DC power diagram.

Table 4-7 User I/O pin descriptions continued.

**Pin 4** + 5 VDC Auxiliary Power

This connection provides +5 VDC for driving external inputs or outputs. The +5 VDC Auxiliary Power output can source up to 0.5 A and is protected by a 0.5 A self-resetting fuse. The return (ground) path must be through Pin 12, Auxiliary DC Power Ground.

**Pin 5** + 24 VDC Auxiliary Power

This connection provides +24 VDC for driving external inputs or outputs. The +24 VDC Auxiliary Power output can source up to 0.5 A and is protected by a 0.5 A self-resetting fuse. The return (ground) path must be through Pin 12, Auxiliary DC Power Ground.

**Pin 12** Auxiliary DC Power Ground

This connection provides a ground (earth) connection for +5 and +24 VDC auxiliary power outputs. This pin is the only User I/O pin that is connected to the laser's chassis ground. Do not use this pin for grounding if I/O circuits are powered from an external customer-supplied DC power source.

### Input signals

A total of four user inputs allow control of Pulstar lasers. Remote Interlock, Shutter Open Request, and Remote Reset/Start Request inputs are optoisolated and bi-directional, allowing for positive or negative polarity signal inputs. These three signals also share a common return

# Technical Reference

## User I/O Connections

connection, Input Common, which is separate from chassis ground to completely isolate control signals for optimal EMI performance. The fourth input, PWM Input, is optoisolated and has a separate return, PWM Return, to fully isolate PWM signals from the other three user inputs. Note that throughout this manual, input voltage levels are specified with respect to their corresponding return line.

**Pin 1** PWM Return

Connect the return side of your PWM Command signal to this pin. Refer to Table 5-4 for input circuit specifications.

**Pin 2** Remote Reset/Start Request

Apply a positive or negative voltage ( $\pm 5\text{--}24$  VDC) with respect to Pin 11, Input Common, to disable the laser. The laser remains disabled while voltage is applied to this pin. Removing voltage from the Remote Reset/Start Request pin causes the laser's RDY lamp to illuminate and begins a five-second countdown after which lasing is enabled. Because all DC power is removed from the laser's RF modules when this input is active, no lasing can occur until voltage is removed from Pin 2. Refer to the following table for input circuit specifications.

**Note:** When connecting field wiring to the Remote Reset/Start Request input, use twisted pair and/or shielded cabling. Refer to SYNRAD® Technical Bulletin #021 for details.

**Pin 3** Remote Interlock

Apply a positive or negative voltage ( $\pm 5\text{--}24$  VDC) with respect to Pin 11, Input Common, to enable lasing. If your system does not use a remote interlock, this pin must be connected to a voltage source in the range of  $\pm 5\text{--}24$  VDC. Refer to the prior figure for a diagram showing how the Remote Interlock input is factory-jumpered on the Quick Start Plug to enable lasing and for troubleshooting purposes. Because all DC power is removed from the laser's RF modules when this input is inactive, no lasing can occur until voltage is applied to Pin 3. See the following table for input circuit specifications.

Remote Interlock faults (INT LED illuminates red) are not latched. Re-applying a voltage to Pin 3 enables the RDY indicator and lasing is possible after the five-second delay, provided that the SHT indicator is also lit.

**Note:** Use the interlock function to provide maximum operator safety. When the Remote Interlock input is opened (voltage source removed), the internal shutter automatically closes to block the beam path, the RDY LED turns Off, the SHT LED turns Off (regardless of the state of the Shutter Open Request input), and all DC power is removed from the RF boards.

**Pin 9** PWM Input

Connect your PWM Command signal (+5 VDC, 5 kHz nominal, 100 kHz max) to Pin 9. This pulse width modulated Command signal controls laser output so that a duty cycle of 22.5% corresponds to a laser output of approximately one-half rated output power and a duty cycle of 37.5% corresponds to approximately full output power. Refer to Controlling laser power in this chapter for further information on laser control signals. Connect the PWM signal source return to Pin 1, PWM Return. See the following table for input circuit specifications.



# Technical Reference

## User I/O Connections

### Pin 10 Shutter Open Request

Apply a positive or negative voltage ( $\pm 5$ –24 VDC) with respect to Pin 11, Input Common, to open the internal EM shutter assembly (when the Remote Interlock input is active). If your system does not supply a Shutter Open Request signal, then this pin must be connected to a voltage source in the range of  $\pm 5$ –24 VDC. Refer to the figure below for a diagram showing how the Shutter Open Request input is factory-jumpered on the Quick Start Plug. See the following table for input circuit specifications.

**Note:** Shutter Open Request and Remote Interlock inputs are dependent control functions. The internal shutter mechanism will not activate (open) until a voltage is also applied to the Remote Interlock input (causing INT LED to illuminate green and RDY LED to turn On)

### Pin 11 Input Common

Use this pin to connect return lines for Remote Interlock, Shutter Open Request, and Remote Reset/Start Request lines. Refer to Table 5-4 for input circuit specifications.

**Warning!** The use of the Quick Start Plug bypasses the laser's safety interlock function, potentially exposing personnel in the area to invisible infrared laser radiation. The Quick Start Plug is intended only for initial testing and troubleshooting by qualified personnel. In normal operation, the laser's Remote Interlock input should be connected to the machine's safety interlock circuitry.

**Serious  
Personal  
Injury**



Figure below illustrates how Remote Interlock and Shutter Open Request inputs are factory-jumpered on the Quick Start Plug to enable lasing for initial testing and troubleshooting purposes.

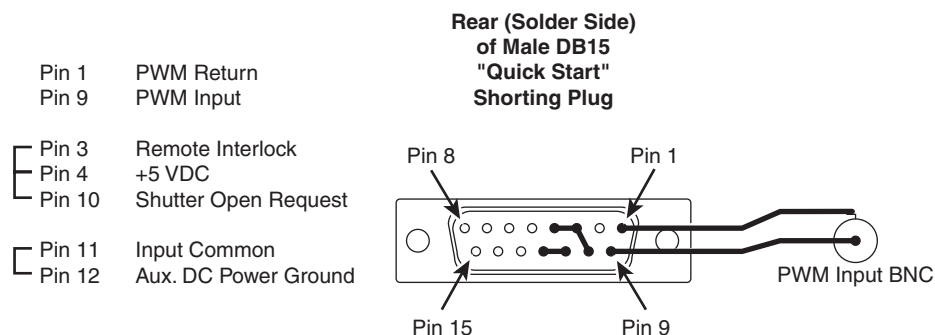

Figure 4-19 Quick Start Plug wiring diagram.

# Technical Reference

## User I/O Connections

The figure below illustrates the input circuit's equivalent internal schematic while the table below provides Pulstar p100/150 input circuit specifications.

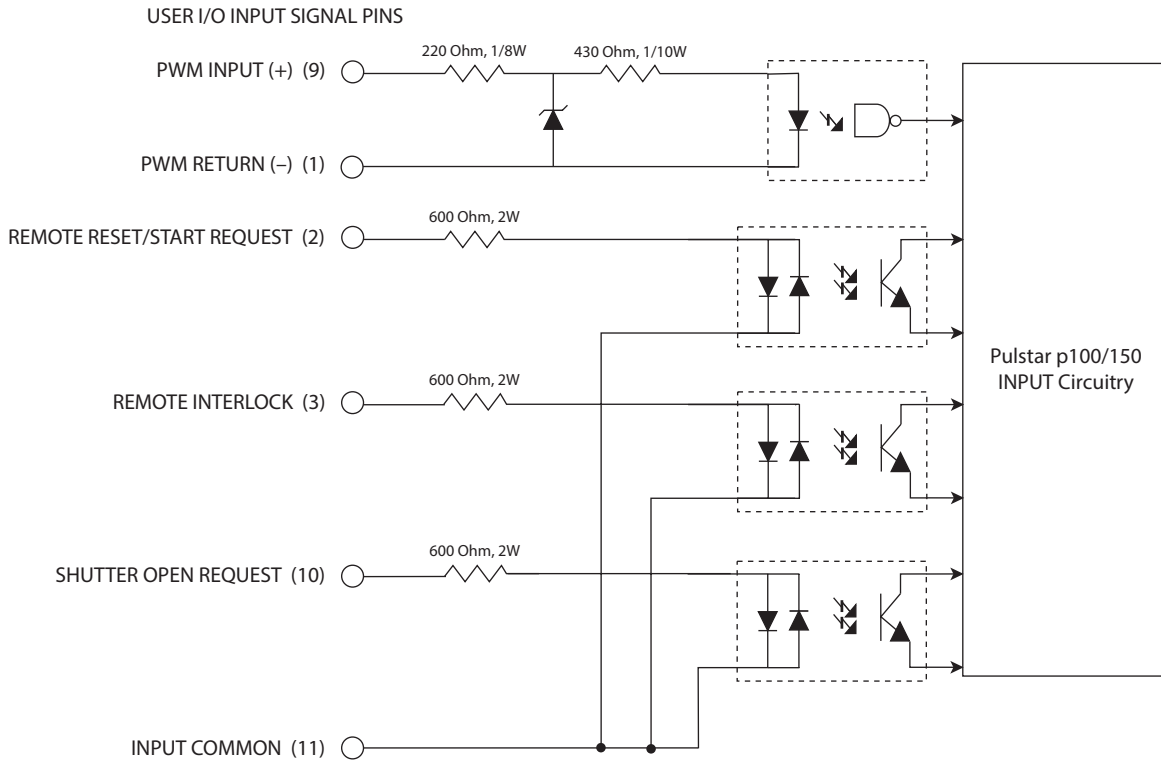

Figure 4-20 Input equivalent schematic.

Table 4.8 Input circuit specifications.

Input Signal Name	Input Device Type and Specifications
PWM Input	High-speed optoisolator LED, forward voltage drop ( $V_f$ ) 1.5 VDC Off state $V_{max}$ +0.8 VDC On state $V_{min}$ +3.5 VDC @ 3 mA On state (continuous) $V_{max}$ +6.7 VDC @ 10 mA Frequency, max. 100 kHz (p100) 200kHz (p150) Max PWM = 37.5% Max Pulse Length = 600 microseconds
Remote Reset/Start Request	Bi-directional optoisolator LED, forward voltage drop ( $V_f$ ) 1.15 VDC
Remote Interlock	Off state $V_{max}$ < 1.0 VDC
Shutter Open Request	On state $V_{min}$ ±5.0 VDC @ 7 mA On state (continuous) $V_{max}$ ±24.0 VDC @ 40 mA

**Note:** The Remote Reset/Start Request input must not be sent until Pulstar's +5 VDC power supply has stabilized (approximately 200 ms after DC power-up).

# Technical Reference

## User I/O Connections

### Output signals

Pulstar's five user outputs correspond to the status functions described below. These outputs are optoisolated solid-state relays that allow for high-side or low-side switching. The shared connection, Output Common, is separate from the laser's chassis ground to allow high-side or low-side switching and to isolate control signals for optimum EMI performance.

Pulstar's optically-isolated outputs are useful for sending laser status to a Programmable Logic Controller (PLC) or computerized control system. Each of the five outputs can source 50 mA at  $\pm 24$  VDC maximum for a total load of 250 mA. For controlling larger loads, use these outputs to drive a control relay.

**Note:** Interlock Open and Shutter Open output signals are dependent control functions. The Shutter Open output will not close (SHT LED On) until a Shutter Open Request signal is applied and the Interlock Open output opens (causing INT LED to illuminate green and RDY LED to turn On).

**Pin 6** Laser Active

This bi-directional switched output is internally connected to Pin 13, Output Common, when the laser is actively lasing (LASE indicator red). This output is open (high impedance) when no beam is being emitted (LASE indicator Off). Refer to Table 4-5 for output circuit specifications.

**Pin 7** Fault Detected

This bi-directional switched output is internally connected to Pin 13, Output Common, when (1) an over-temperature fault (TMP LED is red) or (2) a No-Strike condition (blue SHT indicator is flashing) has occurred. The output is open (high impedance) when laser operation is within limits (TMP LED green and SHT LED blue). Refer to Table 5-5 for output circuit specifications.

**Pin 8** Laser Ready

This bi-directional switched output is internally connected to Pin 13, Output Common, when the laser is enabled (RDY indicator On), indicating that lasing will occur when a PWM Command signal is applied to Pin 9 and Pin 1. When this output is initially switched closed, there is a five-second delay during which lasing is inhibited. This output is open (high impedance) when the laser is disabled (RDY LED Off). Refer to following output circuit specifications table.

**Pin 13** Output Common

Use this pin to complete the return (ground) path for any output connection (Pin 6, 7, 8, 14, or 15). The Output Common line is protected by a 0.3 A self-resetting fuse.

**Pin 14** Shutter Open

This bi-directional switched output is internally connected to Pin 13, Output Common, when Remote Interlock and Shutter Open Request signals are present (SHT LED blue and RDY LED yellow), indicating that lasing is enabled. This output is open (high impedance) when the laser is disabled (SHT LED Off). Refer to following output circuit specifications table.

# Technical Reference

## User I/O Connections

### Pin 15 Interlock Open

This bi-directional switched output is internally connected to Pin 13, Output Common, when remote interlock input circuitry is open (INT indicator red), indicating that lasing is disabled. This output is open (high impedance) when the laser is enabled (INT indicator green). When this output is initially switched open, there is a five-second delay during which lasing is inhibited. See Table 5-5 for output circuit specifications.

Figure below illustrates the output circuit's equivalent internal schematic and the table below provides Pulstar p100/150 output circuit specifications.

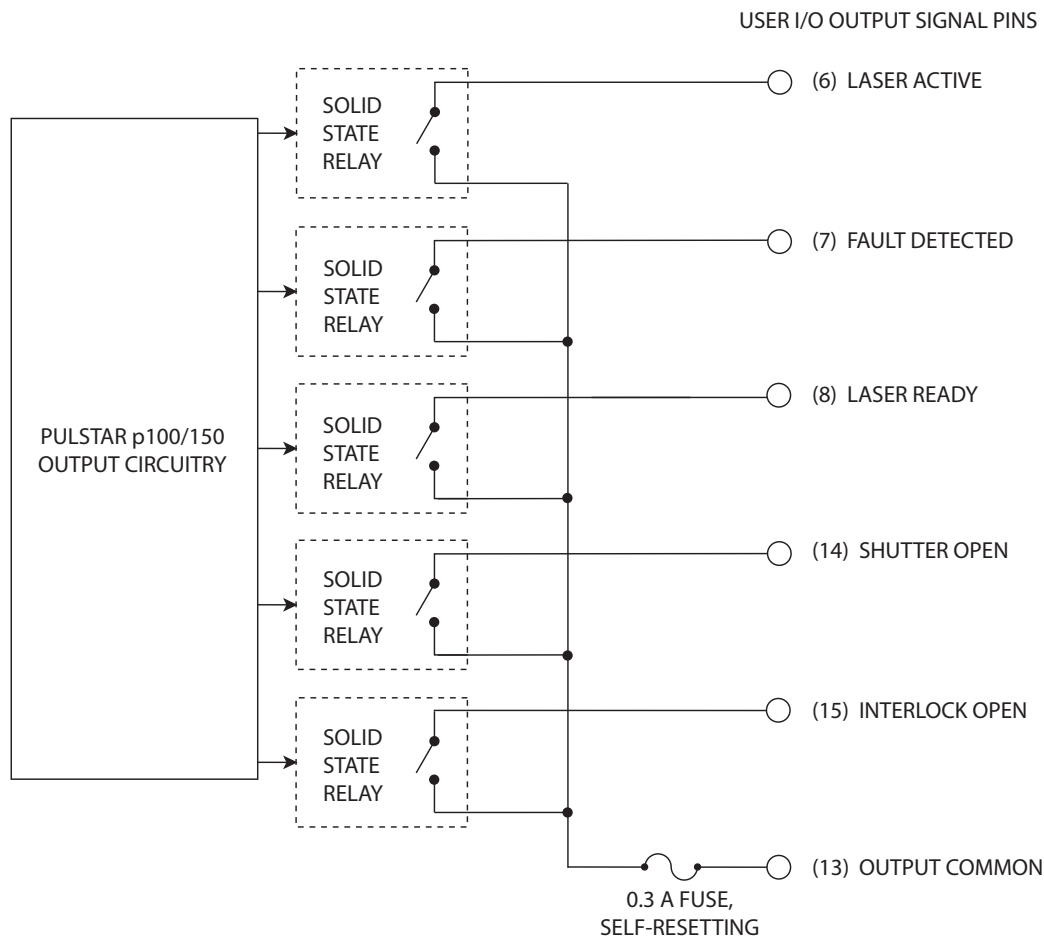

Figure 4-21 Output equivalent schematic.

Table 4.9 Output circuit specifications.

Output Device	Specifications
Bi-directional MOSFET	2.5 Ohms Rdson 10 MOhms Off Voltage $\pm 24$ VDC, max. Current 50 mA, max.

# Technical Reference

## User I/O Connections

### Sample I/O circuits

#### Sample inputs

Figure below illustrates one method of supplying a Remote Interlock signal using a customer-supplied limit switch. Pulstar's +24 VDC Auxiliary Power output powers the circuit. Note that Pin 4, +5 VDC Auxiliary Power, could have been used instead, depending on circuit voltage requirements.

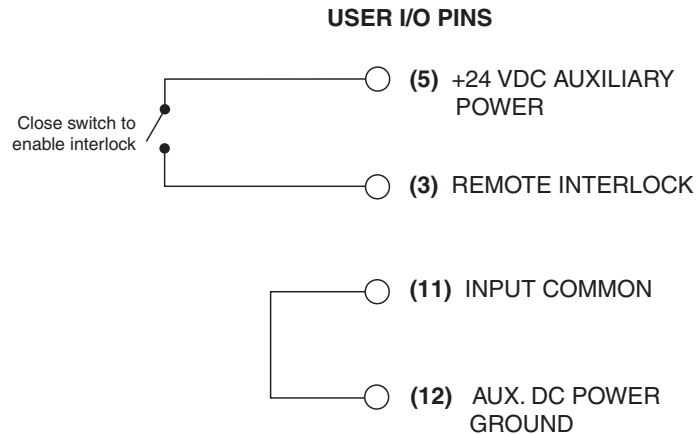

Figure 4-22 Customer-supplied interlock.

The figure below shows another variation for supplying a Remote Interlock signal to the laser. In this case, the customer is using a limit switch and supplying a negative voltage to drive Pulstar's input circuit.

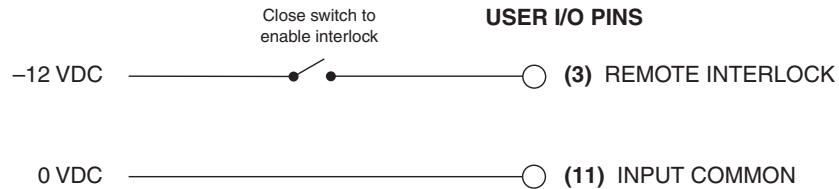

Figure 4-23 Customer-supplied interlock, negative voltage.

# Technical Reference

## User I/O Connections

A Programmable Logic Controller (PLC) can also drive Pulstar inputs. Figure below shows a typical method for connecting to a PLC output module when only one Pulstar input is used.

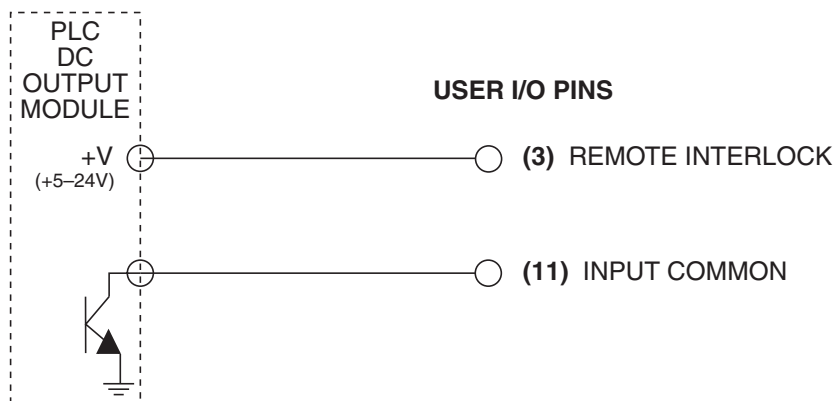

Figure 4-24 PLC driven interlock signal.

When multiple PLC outputs are used, connect Pulstar inputs to the PLC as shown in the figure below. By supplying voltage (+VDC) to Pin 11, Input Common, and pulling individual inputs to ground, each input can be independently activated by the PLC's output module.

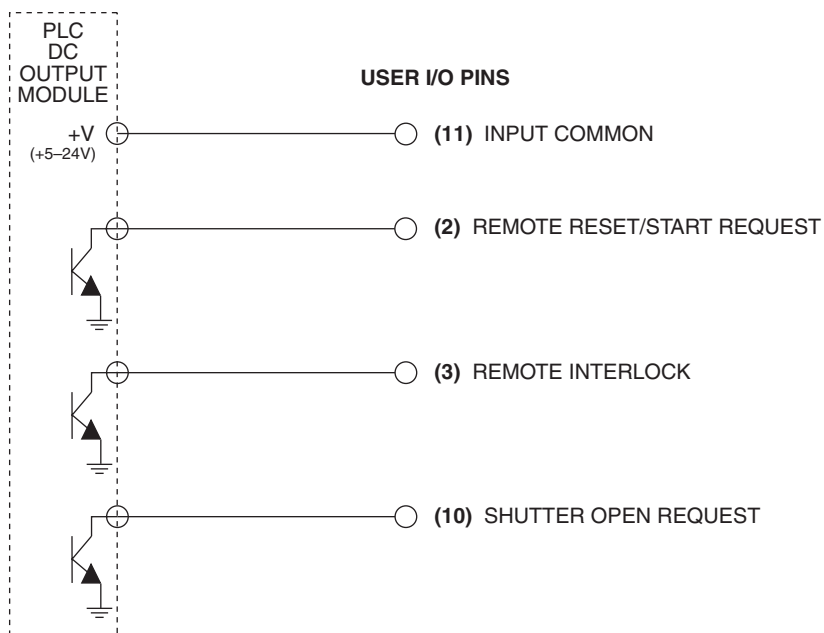

Figure 4-25 Multiple PLC driven inputs.

# Technical Reference

## User I/O Connections

### Sample outputs

Pulstar's optoisolated, bi-directional switched outputs can drive small loads (50 mA max), PLC inputs, or relays that can control higher current loads. The following figure illustrates one method of controlling a remote warning lamp using power supplied by Pulstar's +24 VDC Auxiliary Power output. Remember to size current-limiting resistor, R1, so that the current draw does not exceed 50 mA.

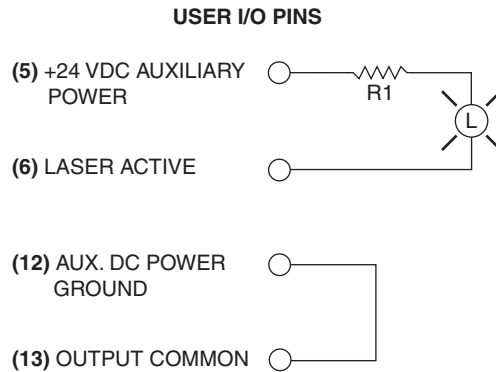

Figure 4-26 Pulstar output driving warning lamp.

The figure below illustrates a method for controlling a higher voltage, higher current load by using a 24V control relay. Ensure that the relay coil's pull-in current does not exceed 50 mA. A diode or surge suppressor must be installed across the relay coil to prevent voltage spikes from damaging Pulstar outputs.

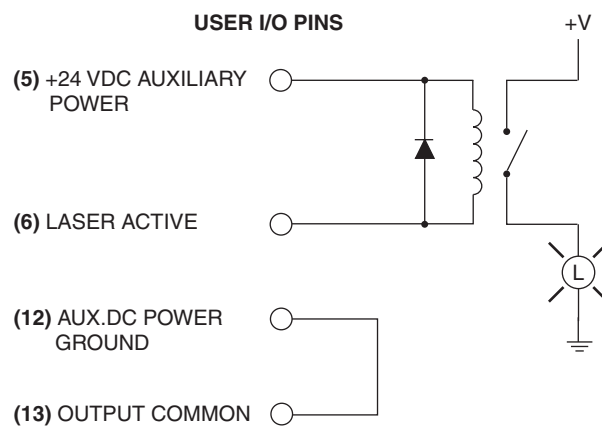

Figure 4-27 Pulstar output driving relay.

# Technical Reference

## User I/O Connections

The figure below illustrates how Pulstar's outputs can drive the DC Input Module of a Programmable Logic Controller (PLC). By supplying voltage (+VDC) to Pin 13, Output Common, each Pulstar output is independently switched to activate individual PLC inputs.

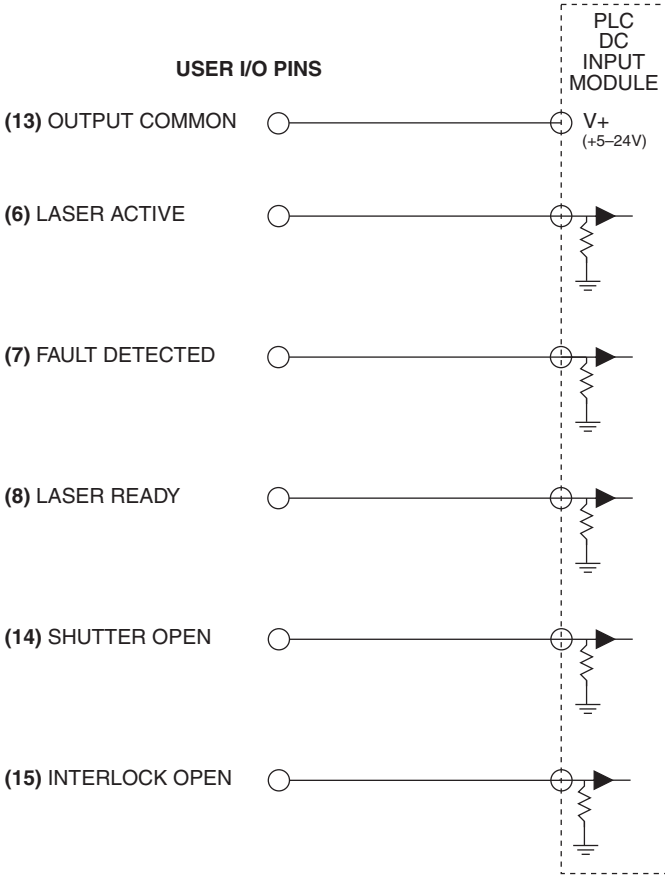

Figure 4-28 Pulstar output driving PLC input module.



# Technical Reference

## DC Power Cables

The DC power cable section:

- DC power cables

### DC power cables

The DC power cables shipped with the Pulstar p100/150 lasers are manufactured with 6 AWG wire to a standard length of 1.8 m (6.0 ft). Diameter 0.162 in requires a minimum bend radius of 1.944 in. Terminals on the laser end of the cables fit the laser's M6 studs while terminals on the power supply ends are sized to fit M6 (0.25") bolts.

When using a power supply other than the PS-48-4000, you can fabricate your own DC voltage sense cable or you can remove the 26-pin HD D-subminiature connector and terminate the sense cable to match your power supply's DC voltage sense connections. Please refer to the power source manual for details.

#### **Warning!** Serious Personal Injury



**Hazardous DC voltages exist on DC power supply output terminals when the power supply is energized.**

**Contacting energized terminals may result in serious personal injury or death.**

**Protect all 48 VDC connections from incidental contact in accordance with local, state, and national code requirements for electrical insulation and labeling.**

**All AC input wiring and fusing to the DC power supply must be sized and connected in accordance with applicable local, state, and National Electrical Code (NEC) requirements.**

**Local, state, and national code requirements supersede any recommendations provided in this manual.**

#### **Caution**

Possible  
Equipment  
Damage



Do not plug and unplug the DC Power cable on the rear of the laser to switch DC power to the laser. Switching power under load causes arcing that will damage the connector and laser control board.

To properly cycle power to the laser, switch the AC power source controlling the DC power supply.

Do not reverse polarity when connecting the DC Power cable to your DC power source. Reversed DC polarity may damage the laser's internal circuitry.

#### **Important Note:**



If you lengthen the DC Power Cables shipped with the p100/150 laser, you must calculate and measure the additional voltage drop to ensure that 48.0 VDC is available at the laser's +48V POWER terminal under full-load conditions. Keep in mind, depending on the additional length required, you may need to use larger gauge (2/0) wire.

# Technical Reference

## Integrating Pulstar Safety Features

The Integrating Pulstar™ safety features section includes subsections:

- Keyswitch functions
- Shutter functions
- Remote interlock functions

Pulstar's DB-15 User I/O connector allows system integrators or end-users to integrate Pulstar safety features into their control system. Pulstar's keyswitch, shutter, and remote interlock functions serve to enable or disable DC power to Pulstar's RF drive. Without DC power, the RF driver cannot supply RF energy to the resonator, causing the CO<sub>2</sub> gas to remain in a zero-energy state. Pulstar status indicators provide users with a quick visual indication of the laser's operational status. All power to the laser's RF board is removed when the RDY indicator is Off (Laser Ready output open).

## Keyswitch functions

### OEM Lasers

On p100/150 OEM lasers, the RDY LED illuminates on DC power-up (when the Remote Interlock input is enabled) and five seconds later, DC power is applied to the RF driver. When the Shutter Open Request input is inactive (SHT indicator Off) no tickle pulse is applied to the laser. PWM Command signals are enabled only when voltage is applied to both Shutter Open Request and Remote Interlock inputs (INT LED green, RDY LED On, and SHT LED On). Over temperature faults are reset by removing and then re-applying DC power after the laser has cooled. Remote interlock faults are not latched; the RDY LED illuminates yellow as soon as the interlock circuit is closed (when the INT LED turns from red to green) and five seconds later lasing is enabled.

Although a Remote Reset/Start Request input is not required to reset OEM faults, it can be used to inhibit (disable) lasing. Disable the laser by applying a voltage in the range of  $\pm 5-24$  VDC to Pin 2, the Remote Reset/Start Request input. Removing voltage allows power to reach the RF driver and begins a five-second countdown after which lasing is enabled (RDY LED illuminates yellow). The RF driver is disabled as long as voltage is applied to Pin 2.

Your control system can monitor the laser's ready status on the User I/O connector by connecting your system's input between Pin 8, Laser Ready, and Pin 13, Output Common (see the figure above).

**Note:** When connecting field wiring to the Remote Reset/Start Request input, use twisted pair and/or shielded cabling. Refer to SYNRAD® Technical Bulletin #021 for details. After the Laser Ready output closes, a five-second delay occurs before lasing is enabled.

The Laser Ready output closes when the laser is enabled (RDY LED illuminated yellow), indicating that lasing is possible. The output is open (RDY LED off) when lasing is disabled.

# Technical Reference

## Integrating Pulstar Safety Features

### Shutter functions

An internal EM shutter is optional for p100/150 lasers, but the electronic shutter is available on all lasers. Lasing is enabled when the shutter is open (SHT LED illuminated blue) and disabled when the shutter is Closed (SHT LED off).

For p100/150 OEM lasers in automated systems, shutter actuation is provided by the (EM) Shutter Open Request signal via Pin 10 on the User I/O connector. To use this feature, apply a voltage in the range of  $\pm 5$ –24 VDC to Pin 10, Shutter Open Request. This input signal causes the SHT LED to illuminate (provided the RDY indicator is On) and opens the physical shutter to allow lasing. Removing voltage from the Shutter Open Request input causes the physical shutter to close and block the beam path, extinguishing the SHT lamp and allowing only tickle signals to reach the tube.

Your control system can monitor the laser's shutter status on the User I/O connector by connecting your system's input to Pin 14, Shutter Open, and Pin 13, Output Common (see Figure 3-16). The Shutter Open output closes when a Shutter Open Request signal is present (SHT LED illuminated blue) and the Laser Ready output is closed (RDY LED is On). The output is open (SHT LED Off) when the Shutter Open Request signal is removed or the Laser Ready output is open (RDY LED is Off).

### Remote interlock functions

Interlock circuits are often used to disable machinery when a shield, panel, or door is opened. Pulstar's remote interlock function allows you to connect into an external remote interlock circuit and prevent lasing by removing DC power from the laser's RF driver boards when the circuit is electrically "open".

Lasing is enabled when a Remote Interlock signal is present (INT LED illuminated green), if the RDY LED is illuminated and a Shutter Open Request signal is applied. Lasing is disabled when the Remote Interlock signal is removed (INT LED red, RDY LED off). DC power is applied to the RF driver only when the INT LED is green and the RDY LED is yellow. Remote interlock functionality is provided by the Remote Interlock signal via Pin 3 on the User I/O connector.

To use Pulstar's remote interlock feature to initiate lasing, apply a voltage in the range of  $\pm 5$ –24 VDC to Pin 3, Remote Interlock. Applying a Remote Interlock signal causes the INT LED to turn green, the RDY indicator to turn yellow, and sends DC power to the laser's RF boards. After a five-second delay, a tickle signal is applied to the tube. When a Shutter Open Request signal is present, PWM Command signals are enabled to begin lasing. Removing voltage stops DC power from reaching the RF driver, causing the INT LED to turn red and the RDY LED to turn Off. Lasing remains disabled until a voltage is reapplied to Pin 3.

Your control system can monitor the laser's remote interlock status on the User I/O connector by connecting your system's input to Pin 15, Interlock Open, and Pin 13, Output Common (see Figure 4-25). This output is closed when remote interlock circuitry is open (INT LED illuminated red). The output is open (INT LED green) when interlock circuitry is closed.

# Technical Reference

## Integrating Pulstar Safety Features

Table 4.10 Pulstar p100 general specifications.

Parameter	p100 (10.2 $\mu\text{m}$ )	p100 (10.6 $\mu\text{m}$ )
<b>Output Specifications</b>		
Wavelength typical ( $\mu\text{m}$ )	10.25 $\pm$ 0.1	10.6 $\pm$ 0.1
Average Power Output (minimum) <sup>2</sup>	90 W	100 W
Peak Power, typ <sup>1</sup>	375 W	400 W
Peak Pulse Energy, (maximum)	180 mJ (tested at 625 Hz, 37.5% Duty Cycle)	190 mJ (tested at 625 Hz, 37.5% Duty Cycle)
Power Stability, from cold start (typ) <sup>3</sup>	$\pm$ 7%	
Power Stability, after 3 min (typ) <sup>3</sup>	$\pm$ 5%	
Mode Quality <sup>3</sup>	$M^2 \leq 1.2$	
Beam Waist Diameter (at $1/e^2$ ) <sup>3</sup>	7.5 mm $\pm$ 1.1 mm	
Beam Waist Diameter at faceplate (at $1/e^2$ ) <sup>3</sup>	7.5 mm $\pm$ 1.1 mm	8.0 mm $\pm$ 1.0 mm
Beam Divergence, full angle (at $1/e^2$ ) <sup>3</sup>	1.8 mrad $\pm$ 0.4 mrad	2.0 mrad $\pm$ 0.4 mrad
Ellipticity <sup>3</sup> & Ellipticity far field <sup>3</sup>	$\leq 1.2$	
Polarization	Linear, vertical	
Rise and Fall Time <sup>1</sup>	< 40 $\mu\text{s}$ (Rise) < 80 $\mu\text{s}$ (Fall)	< 40 $\mu\text{s}$ (Rise) < 100 $\mu\text{s}$ (Fall)
<b>Input Specifications</b>		
Power Supply		
Input Voltage / Current (maximum)	48 VDC / 40 A	
Peak Current Amps	75 A (for < 700 $\mu\text{s}$ )	
Command Input Signal		
Voltage	+3.5 to +6.7 VDC (5V nominal)	
Current	10 mA @ +6.7 VDC	
Frequency Range	Single shot to 100 kHz	
Duty Cycle Range <sup>1</sup>	$\leq 37.5\%$	
Pulse Length, max	600 $\mu\text{s}$	
Logic Low State (Vmin–Vmax)	0.0 to +0.8 VDC	
Logic High State (Vmin–Vmax)	+3.5 to +6.7 VDC	
<b>Environmental Specifications</b>		
Operating Temperature <sup>7</sup>	15 $^{\circ}\text{C}$ –40 $^{\circ}\text{C}$	
Humidity	0-95%, non-condensing	

# Technical Reference

## Pulstar p100 /150 General Specifications

Table 4.10 Pulstar p100 general specifications. (Continued)

Parameter	p100 (10.2 μm)	p100 (10.6 μm)
<b>Cooling Specifications</b>		
Maximum Heat Load, laser	2000 Watts	
Flow Rate	1.5–2.0 GPM, < 60 PSI (5.7-7.6 LPM, <414 kPa)	
Pressure Drop (Supply Input)	18 PSI @ 1.5 GPM/32 PSI @ 2.0 GPM, (124 kPa @ 5.7 LPM/221 kPa @ 7.6 LPM)	
Coolant Temperature <sup>4</sup>	18–22 °C	
Coolant Temperature Stability	± 1.0 °C	
Coolant	Water	
<b>Physical Specifications</b>		
Length	23.2 in (590 mm)	
Width	5.2 in (132 mm)	
Width	6.1 in (155 mm)	
Weight	30.0 lb (13.6 kg)	
<p>* Specifications subject to change without notice. Measurements performed at 5 kHz, 37.5% duty cycle unless otherwise noted.</p> <p>1 Measured at 1kHz, 10% Duty Cycle.</p> <p>2 Power level guaranteed for 24 months from date of shipment, regardless of hours, provided laser is operated within the recommended coolant flow-rate and operating temperature range.</p> <p>3 At coolant temperatures above 22 °C, derate power 0.5 W/°C to 1 W/°C up to a coolant temperature of 28 °C.</p>		

# Technical Reference

## Pulstar p100 /150 General Specifications

Table 4.11 Pulstar p150 general specifications.

Parameter	p150 (9.3 $\mu\text{m}$ )	p150 (10.2 $\mu\text{m}$ )	p150 (10.6 $\mu\text{m}$ )
<b>Output Specifications</b>			
Wavelength typical <sup>†</sup>	9.3 $\mu\text{m} \pm 0.1 \mu\text{m}$	10.25 $\mu\text{m} \pm 0.1 \mu\text{m}$	10.60 $\mu\text{m} \pm 0.1 \mu\text{m}$
Average Power Output (minimum) <sup>2</sup>	150 W		
Peak Power, typ <sup>1</sup>	600 W	550 W	600 W
Peak Pulse Energy, (maximum)	335 mJ <small>Tested at 625Hz, 37.5% Duty Cycle</small>		
Power Stability, from cold start	$\pm 5\%$	$\pm 6\%$	
Power Stability, after 3 min (typ)	$\pm 3\%$		
Mode Quality	$M^2 \leq 1.2$		
Beam Waist Diameter (at $1/e^2$ )	8.0 mm $\pm 1.1$ mm		
Beam Waist Diameter at faceplate (at $1/e^2$ )	8.5 mm $\pm 1.0$ mm		
Beam Divergence, full angle (at $1/e^2$ )	1.9 mrad $\pm 0.4$ mrad		
Ellipticity <sup>3</sup> & Ellipticity far field	$\leq 1.2$		
Polarization	Linear, vertical		
Rise and Fall Time <sup>1</sup>	$< 50 \mu\text{s}$ <small>(Rise)</small> $< 100 \mu\text{s}$ <small>(Fall)</small>		
<b>Input Specifications</b>			
Power Supply			
Input Voltage / Current	48 VDC / 65 A		
Peak Current Amps	100 A for $< 700 \mu\text{s}$		
Command Input Signal			
Voltage	+3.5 to +6.7 VDC (5V nominal)		
Current	10 mA @ +6.7 VDC		
Frequency Range	Single shot to 160 kHz		
Duty Cycle Range <sup>1</sup>	$\leq 37.5\%$		
Pulse Length, max	600 $\mu\text{s}$		
Logic Low State (Vmin–Vmax)	0.0 to +0.8 VDC		
Logic High State (Vmin–Vmax)	+ 3.5 to + 6.7 VDC		
<b>Environmental Specifications</b>			
Operating Temperature	15 °C–40 °C		
Humidity	0-95%, non-condensing		

# Technical Reference

## Pulstar p100 /150 General Specifications

Table 4.11 Pulstar p150 general specifications. (Continued)

Parameter	p150 (9.3 μm)	p150 (10.2 μm)	p150 (10.6 μm)
<b>Cooling Specifications</b>			
Maximum Heat Load, laser	3500 W		
Flow Rate	2.0 GPM at < 60 PSI (15.1 LPM at <414 kPa)		
Pressure Drop	19 PSI @ 1.5 GPM/34 PSI @ 2.0 GPM, (131 kPa @ 5.7 LPM/234 kPa @ 7.6 LPM)		
Coolant Temperature <sup>3</sup>	18–22 °C		
Coolant Temperature Stability	± 1.0 °C		
Coolant	Water		
<b>Environmental Specifications</b>			
Length	31.4 in (798 mm)		
Width	5.2 in (132 mm)		
Height	6.1 in (155 mm)		
Weight	40.0 lb (18.1 kg)		
<p>* Specifications subject to change without notice. Measurements performed at 5 kHz, 37.5% duty cycle unless otherwise noted.</p> <p>† Typical wavelength band for 10.6 μm nominal, but laser can operate in 10.2–10.7 μm range.</p> <p>1 Measured at 1kHz, 10% Duty Cycle.</p> <p>2 Power level guaranteed for 24 months from date of shipment, regardless of hours, provided laser is operated within the recommended coolant flow-rate and operating temperature range.</p> <p>3 At coolant temperatures above 22 °C, derate power 0.5 W/°C to 1 W/°C up to a coolant temperature of 28 °C.</p>			

# Technical Reference

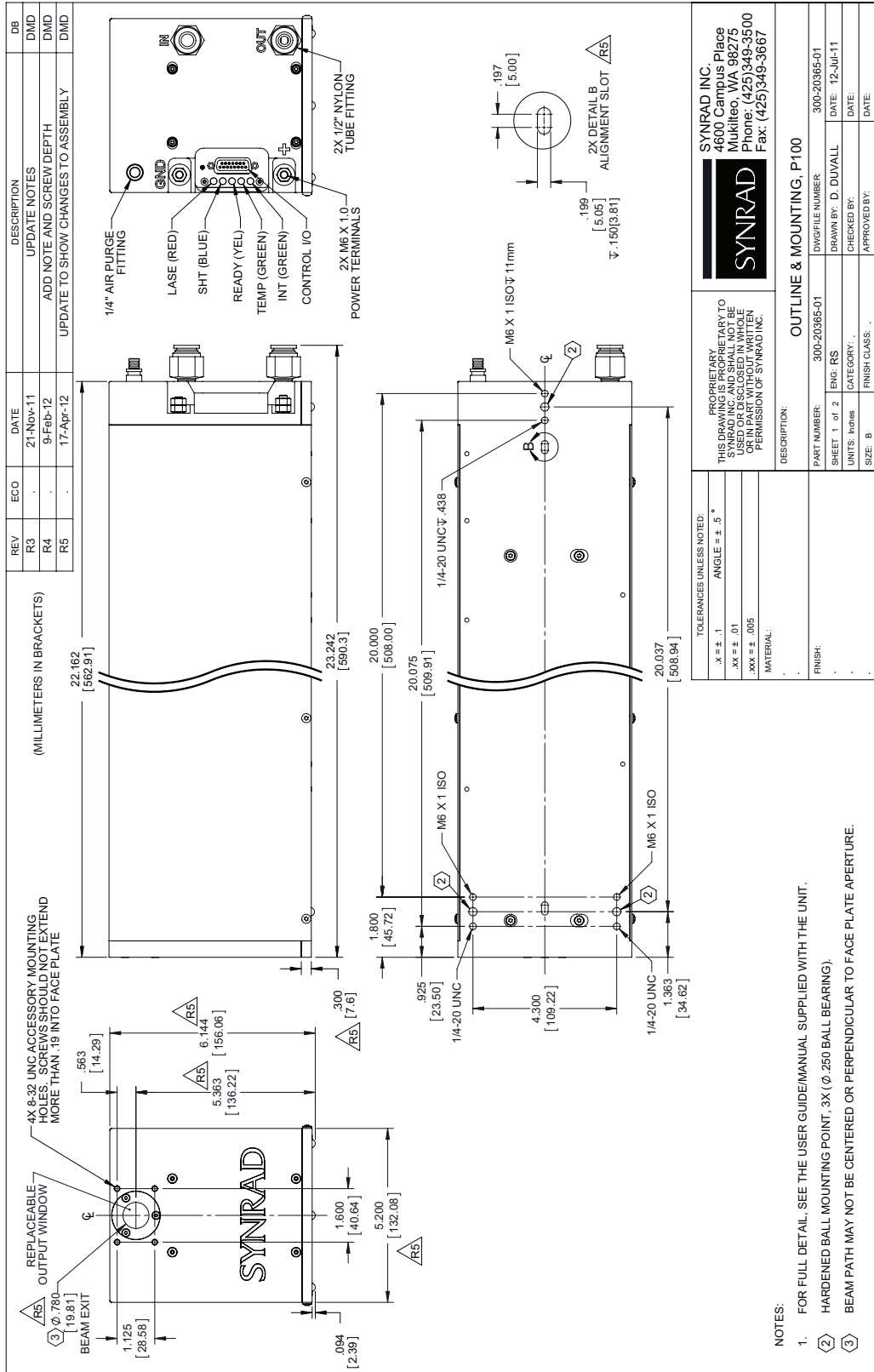

Figure 4-29 Pulstar p100/150 outline & mounting drawings pg 1 of 2.



# Technical Reference

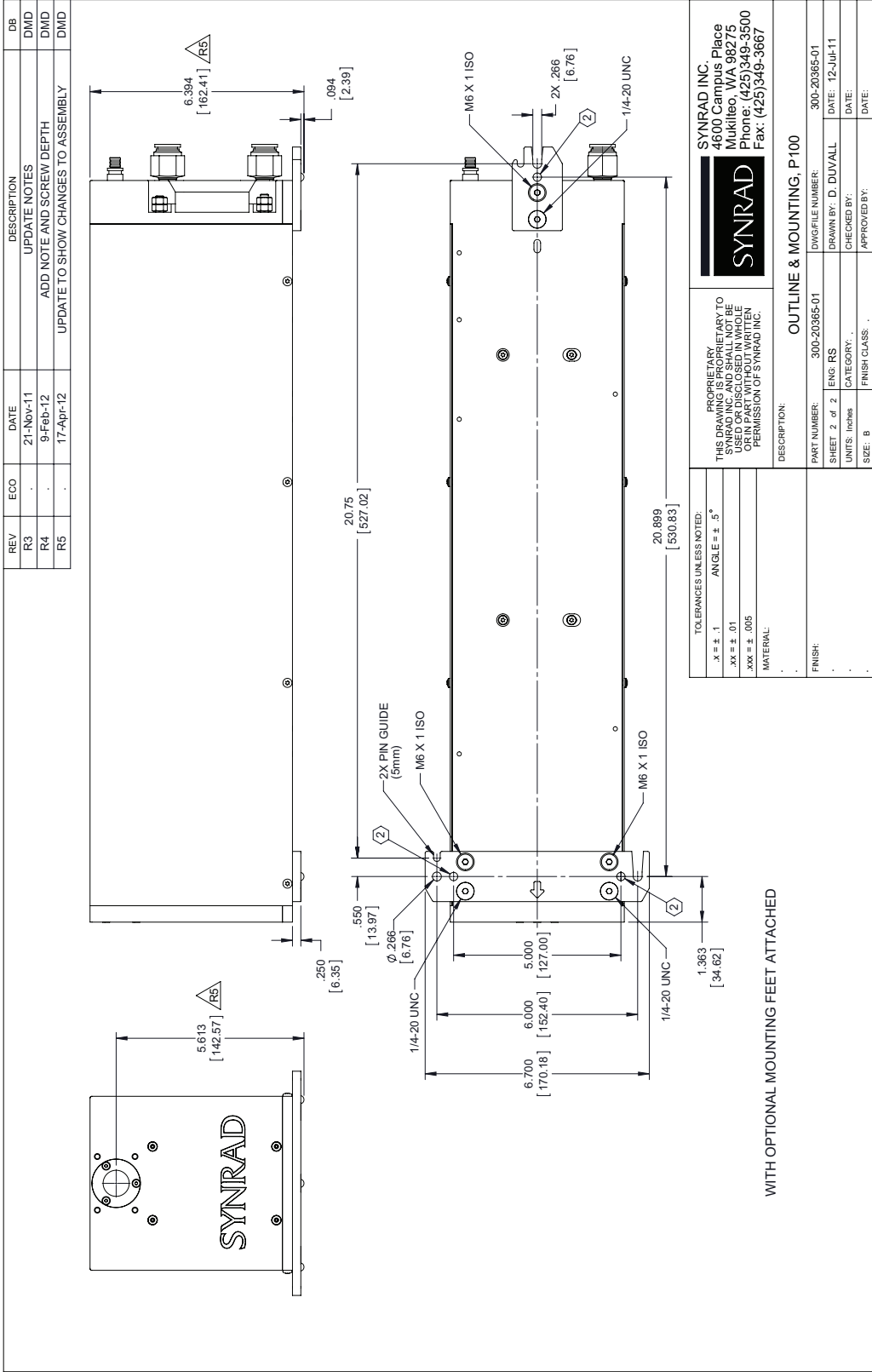

Figure 4-30 Pulstar p100 outline and mounting drawings pg 2 of 2.

# Technical Reference

REV	ECO	DATE	DESCRIPTION	DB
R1	.	7-Mar-12	PRELIMINARY DRAWING	DMD
.	.	.	.	.
.	.	.	.	.

**STEP BY STEP PACKAGING INSTRUCTIONS:**

1. POSITION BOX SO LOGO ON TOP FLAP IS FACING YOU (LOGO WILL BE ON THE LEFT SIDE).
2. POSITION BOTTOM FOAM INSIDE BOX AS SHOWN.
3. PLACE LASER INSIDE FOAM CAVITIES AS SHOWN.
4. MAKING SURE FRONT OF LASER IS ON THE LEFT SIDE. PLACE TOP FOAM OVER LASER AND SECURE INTO BOTTOM FOAM NOTCHES AS SHOWN.
5. WRITE SYNRAD RETURN AUTHORIZATION NUMBER ON OUTSIDE OF SHIPPING BOX.

<b>MATERIAL:</b> SEE BOM	<b>PROPRIETARY</b> THIS DRAWING IS PROPRIETARY TO SYNRAD INC. AND SHALL NOT BE USED OR DISCLOSED IN WHOLE OR IN PART WITHOUT WRITTEN PERMISSION OF SYNRAD INC.	<b>SYNRAD INC.</b> 4600 Campus Place Mukilteo, WA 98275 Phone: (425)349-3500 Fax: (425)349-3667	
<b>FINISH:</b>	<b>DESCRIPTION:</b> PACKAGING, P100/150		
	<b>PART NUMBER:</b> 900-20434-01	<b>DWG/FILE NUMBER:</b> 900-20434-01	
	<b>SHEET 1 of 1</b>	<b>ENG.:</b> D. DUVAL	<b>DATE:</b> 7-Mar-12
	<b>UNITS:</b> Inches	<b>CATEGORY:</b> I	<b>CHECKED BY:</b>
	<b>SIZE:</b> A	<b>FINISH CLASS:</b>	<b>APPROVED BY:</b>
			<b>DATE:</b>

**IMPORTANT NOTE:** FAILURE TO PROPERLY PACKAGE LASER USING SYNRAD SHIPPING BOX AND FOAM/CARDBOARD INSERTS AS SHOWN MAY VOID WARRANTY. CUSTOMERS MAY INCUR ADDITIONAL REPAIR CHARGES DUE TO SHIPPING DAMAGE CAUSED BY IMPROPER PACKAGING.

Figure 4-31 Pulstar p100/150 packaging instructions.

# Technical Reference

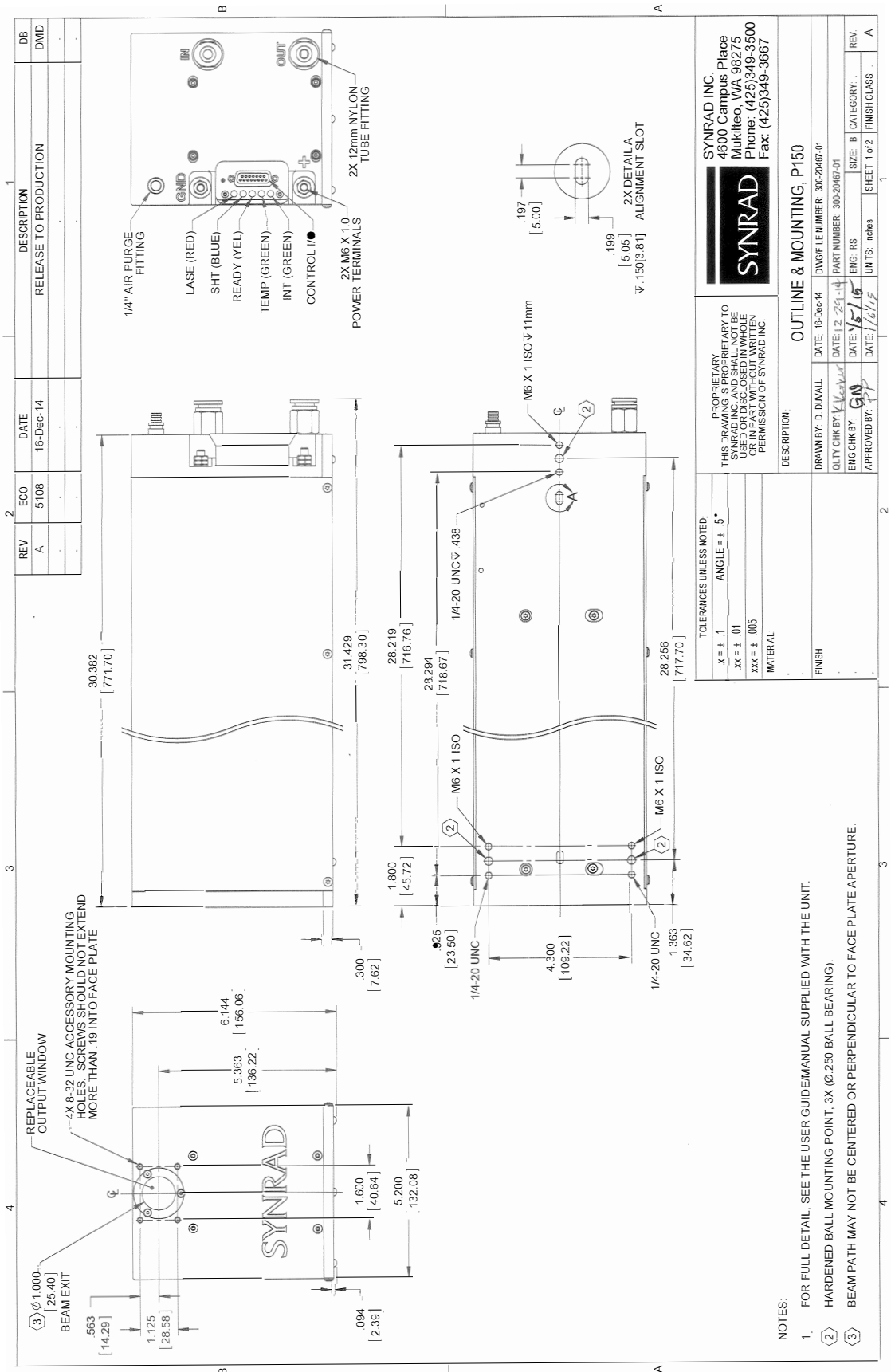

Figure 4-32 Pulstar p150 outline and mounting.

# Maintenance/ Troubleshooting

## 6

Use information in this chapter to perform maintenance or troubleshoot your Pulstar™ p100/150 laser.

This chapter contains the following information:

- Maintenance – describes typical Pulstar p100/150 maintenance procedures.
- Troubleshooting – explains how to troubleshoot common Pulstar p100/150 problems.

**Important Note:**



This section of the Operation Manual explains how to conduct regular maintenance and/or basic troubleshooting to Pulstar p100/150 lasers. If you cannot attend to the unit using the information described in this manual, contact SYN-RAD®, (+.425.349.3500) or an authorized SYN-RAD Distributor.

**Caution**  
Possible  
Equipment  
Damage



**Inlet cooling water temperature must always be maintained above the dew point to prevent condensation and water damage to your Pulstar laser.**

-Or-

**Use purge gas to prevent condensation damage if the dew point is over 22°C**

**Do not exceed a gas purge pressure of 34.5 kPa (5 PSI).** Excessive pressure may damage the purge assembly or other internal laser components.

**Do not use argon as a purge gas.** Use only nitrogen or clean, dry air as described in the in this chapter.

# Maintenance/ Troubleshooting

The Maintenance section includes subsections:

- Disabling the p100/150 laser
- Daily inspections
- Storage/shipping
- Cleaning optical components

## Disabling the p100/150 laser

Before performing any maintenance on your Pulstar™ p100/150 laser, be sure to completely disable the laser by disconnecting the DC Power Cables from the DC power supply.

## Daily inspections

Perform the following steps daily to keep your Pulstar p100/150 laser in optimum operating condition. Except for the procedures described below, no other service is required or should be attempted.

**Caution**  
Possible  
Equipment  
Damage



If you operate the laser in dirty or dusty environments, contact SYNRAD® about the risks of doing so and precautions you can take to increase the longevity for the laser system and associated optical components.

**Warning**  
Serious  
personal  
injury



A risk of exposure to toxic elements, like zinc selenide, may result when certain optical or beam delivery components are damaged.

In the event of damage to the laser or beam delivery optics, contact SYNRAD® or the optics manufacturer for handling instructions.

- 1 Inspect all cooling tubing connections for signs of leakage. Check for signs of condensation that may indicate the cooling water temperature has been set below the dew point temperature. Condensation will damage electrical and optical components inside the laser.
- 2 When using compressed air as a purge gas on your p100/150 laser, empty water traps and oil separators on each filter and/or dryer between the laser and your compressed air source. Compressed & purge gas purity must meet the specifications shown in the Technical References chapter.

# Maintenance/ Troubleshooting

- 3 Inspect beam delivery components for signs of dust or debris and clean as required. When cleaning the optical surfaces of beam delivery components, carefully follow the manufacturer's instructions.
- 4 Inspect external beam delivery components for signs of dust or debris and clean as required. When cleaning the optical surfaces, carefully follow the manufacturer's instructions. Visually inspect the exterior housing of the laser to ensure that all warning labels are present. Refer to the Laser Safety chapter for p100/150 label types and locations.

## Storage/shipping

When preparing the laser for storage or shipping, remember to drain cooling water from the laser. In cold climates, any water left in the cooling system may freeze, which could damage internal components. After draining thoroughly, use compressed shop air at no more than 200 kPa (29 PSI)—Wear safety glasses!—to remove any residual water. When finished, cap all connectors to prevent debris from entering the cooling system.

When shipping SYNRAD® lasers to another facility, we highly recommend that you ship the unit in its original SYNRAD shipping container. If you no longer have the original shipping box and inserts, contact SYNRAD Customer Service about purchasing replacement packaging. Refer to Packaging instructions in the Technical Reference chapter for detailed instructions on properly packaging the laser for shipment.

### **Warning**

**Serious  
personal  
injury**



**Ensure that DC power to the laser is turned off and locked out before inspecting optical components in the beam path.**

**Invisible CO<sub>2</sub> laser radiation is emitted through the aperture. Corneal damage or blindness may result from exposure to laser radiation.**

**Caution**  
**Possible  
Equipment  
Damage**



Even small amounts of contamination on optics in the beam path can absorb enough energy to damage the optic. Inspect beam delivery optics periodically for signs of contaminants and carefully clean as required. In dirty environments, purge laser optics using filtered air or nitrogen to prevent vapor and debris from accumulating on optical surfaces.

**Important** – Pulstar™ p100/150 lasers have several beam conditioning optics between the output aperture and the faceplate. To prevent dust and debris from damaging these optical surfaces, always connect nitrogen or filtered air to the laser's Gas Purge port.

**Important  
Note:**



Failure to properly package the laser using SYNRAD®-supplied shipping boxes and foam/cardboard inserts as shown in the Packaging instructions may void the warranty. Customers may incur additional repair charges for shipping damage caused by improper packaging.

# Maintenance/ Troubleshooting

## Cleaning optical components

Debris or contaminants on external beam delivery components may affect laser processing and lead to damage or failure of the optics and/or the laser. Carefully follow the steps below to inspect and clean the optical components in the beam path. Before beginning the cleaning process, read this entire section thoroughly to ensure that all cleaning materials are available and that each step is completely understood.

**Important Note:**  Exercise great care when handling infrared optics; they are much more fragile than common glass materials. Optical surfaces and coatings are easily damaged by rough handling and improper cleaning methods.

## Cleaning guidelines

- Wear latex gloves or finger cots (powder-free) to prevent contamination of optical surfaces by dirt and skin oils.
- Never handle optics with tools; always use gloved hands or fingers.
- Hold optics by the outer edge; never touch the coated surface.
- Always place optics lens on a tissue or suitable equivalent material for protection; never place optics on hard or rough surfaces.
- It may be necessary to use a cotton ball or fluffed cotton swab instead of a lens wipe to uniformly clean the entire surface of small-diameter mounted optics.
- Before using any cleaning agents, read Material Safety Data Sheets (MSDS) and observe all necessary safety precautions.

## Required cleaning materials

The table below lists the type and grade of materials required to properly clean optical surfaces.

Table 6.1 Required cleaning materials.

Cleaning Material	Requirements
Latex gloves or finger cots	Powder-free
Air bulb	Clean air bulb
Ethyl or isopropyl alcohol	Spectroscopic or reagent grade
Acetone	Spectroscopic or reagent grade
Lens wipe (preferred)	Optical (clean-room) quality
Cotton balls or cotton swabs	High-quality surgical cotton/high-quality paper-bodied

# Maintenance/ Troubleshooting

## **Caution** Possible Equipment Damage



Do not allow the nozzle of the air bulb to touch the optical surface. Any contact may damage the optic by scratching coatings on the optical surface.

Do not use compressed shop air to blow contamination from the optic. Compressed air contains significant amounts of water and oil that form adsorbing films on the optical surface.

Do not exert pressure on the surface of the optic during cleaning. Optical surfaces and coatings are easily scratched by dislodged contaminants.

Use a new lens wipe on each pass as contaminants picked up by the wipe may scratch the optical surface.

## Cleaning optics

- 1 Shut off and lock out all power to the laser. You must verify that the laser is OFF (in a zero-energy state) before continuing with the optical inspection!
- 2 Visually inspect all optical surfaces in the beam path for contaminants.
- 3 Remove loose contaminants from the optic by holding a clean air bulb at an angle to the optic and blow a stream of air at a glancing angle across the lens surface. Repeat as necessary.

### **Important Note:**

If acetone is used as a cleaning solvent, a second follow-up cleaning of the optical surface using alcohol is required.

- 4 Dampen a lens wipe with the selected cleaning agent. Alcohol (least aggressive) is best for initial surface cleaning. Acetone (moderately aggressive) is best for oily residue or minor baked-on vapors and debris.
- 5 Gently, and without applying pressure, drag the damp lens wipe across the optical surface in a single pass. Do not rub or apply any pressure, especially when using a cotton swab. Drag the wipe without applying any downward pressure. Use a clean lens wipe on each pass. The wipe will pick up and carry surface contaminants that may scratch optical surfaces or coatings.

**Note:** To prevent streaking during the final alcohol cleaning, drag the lens wipe slowly across the surface so that the cleaning liquid evaporates right behind the wipe.

- 6 Carefully examine the optic under suitable lighting. Certain contaminants or damage such as pitting cannot be removed. In these cases the optic must be replaced to prevent catastrophic failure.
- 7 Repeat Steps 4 through 6 as required, removing all traces of contaminants and deposits.



# Maintenance/ Troubleshooting

The Troubleshooting section includes subsections:

- Operational flowchart
- Functional block diagram
- Status LEDs
- Laser fault indications

The Troubleshooting section is designed to help isolate problems to the module level only. Problems on circuit boards or the laser tube are outside the scope of this guide because they are not user-serviceable assemblies; do not attempt to repair them. Contact SYNRAD® or a SYNRAD Authorized Distributor for repair information.

To troubleshoot Pulstar™ p100/150 lasers, it is necessary to understand the sequence of events that must happen before the laser can operate. Before attempting any service, we advise you to read the entire troubleshooting guide and review both the operational flowchart and the functional block diagram.

## **Warning** **Serious personal injury**



This Class 4 laser product emits invisible infrared laser radiation in the 10.6  $\mu\text{m}$  CO<sub>2</sub> wavelength band. Since direct or diffuse laser radiation can inflict severe corneal injuries, always wear eye protection when in the same area as an exposed laser beam. Do not allow the laser beam to contact a person. This product emits an invisible laser beam that is capable of seriously burning human tissue.

Always be aware of the beam's path and always use a beam block while testing.

## **Caution** **Possible Equipment Damage**



Attempting repair of a SYNRAD Pulstar laser without the express authorization of SYNRAD, will void the product warranty. If troubleshooting or service assistance is required, please contact SYNRAD Customer Service.

# Maintenance/ Troubleshooting

## Operational flowchart

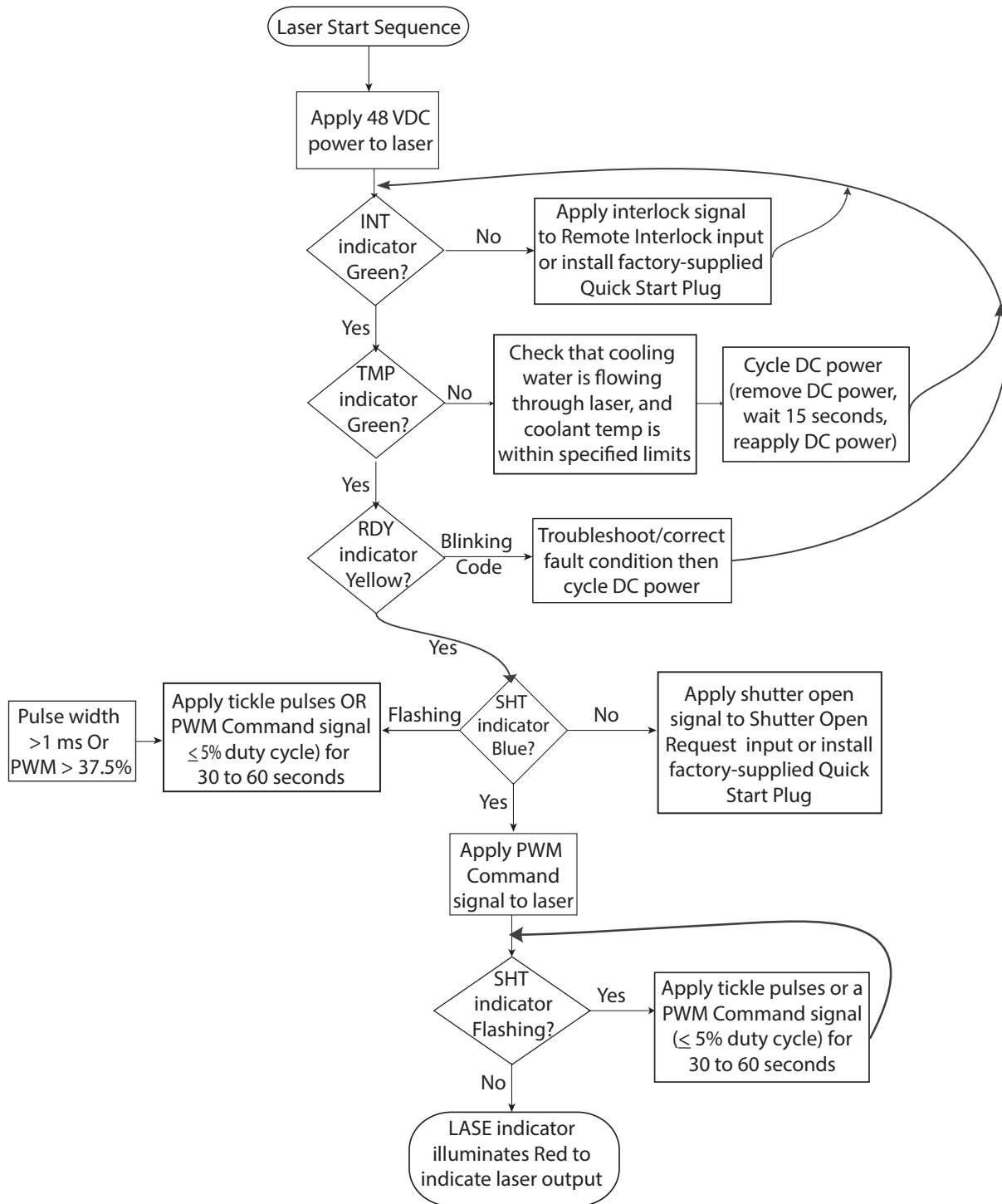

Figure 6-1 Pulstar p100/150 operational flowchart.

# Maintenance/ Troubleshooting

## Status LEDs

LED and I/O States, Pulstar series, P100 and P150 only

LASER CONDITION / FAULT	INPUT STATUS				LED STATUS					OUTPUT STATUS				COMMENTS	
	Remote Interlock	Remote Reset/ Start Request	Shutter Open Request	PWM	INT	TMP	RDY	SHT	LASE	Interlock Open	Fault Detected	Laser Ready	Shutter Open		Laser Active
DC Power Off	x	x	x	x	○	○	○	○	○					No RF to tube	
DC Power Applied, Laser Disabled	0	x	x	x	●	○	○	○	○	C				No RF to tube	
	x	1	x	x	●	○	○	○	○					Tickle applied to tube for 5 seconds, then laser may fire	
	x	x	0	x	●	○	○	○	○						
DC Power Applied, Laser Enabled	1	0	1	0	●	○	○	○	○		C	C	C	Normal laser operation	
Laser Firing	1	0	1		●	○	○	○	○					No RF to tube	
Interlock Open	0	0	1	x	●	○	○	○	○	C				Cooling problem	
Over Temperature	1	0	1	x	●	○	○	○	○		C			Voltage below 46VDC	
Under Voltage	1	x	1	x	●	○	○	○	○					Voltage over 50VDC	
Over Voltage	1	x	1	x	●	○	○	○	○					Laser service required	
RF Drive Switch Fault	1	x	1	x	●	○	○	○	○					Laser service required	
PWM Drive Fault	1	x	1	x	●	○	○	○	○					Laser service required	
Internal Humidity; Laser Quits Lasing	1	0	1	x	●	○	○	○	○					>95% Relative Humidity inside laser chassis	
No Strike Fault	1	0	1	x	●	○	○	○	○					Output limited to 5%	
Frequency Limit Condition	1	0	1	x	●	○	○	○	○					Lower PWM frequency below 100kHz to clear fault	
Duty Cycle / Pulse Width Limit Condition	1	0	1	x	●	○	○	○	○					Lower Duty Cycle below 37.5% or Pulse Width below 600µs	
<b>TABLE KEY:</b>	0 = Input OFF 1 = Input ON x = Does not matter LED 1: Solid green LED 2: Blinking green LED 3: Solid red LED 4: Solid blue LED 5: Solid yellow LED 6: Solid orange LED 7: Solid purple LED 8: Solid pink LED 9: Solid light blue LED 10: Solid light green LED 11: Solid light yellow LED 12: Solid light orange LED 13: Solid light pink LED 14: Solid light purple LED 15: Solid light blue LED 16: Solid light green LED 17: Solid light yellow LED 18: Solid light orange LED 19: Solid light pink LED 20: Solid light purple LED 21: Solid light blue LED 22: Solid light green LED 23: Solid light yellow LED 24: Solid light orange LED 25: Solid light pink LED 26: Solid light purple LED 27: Solid light blue LED 28: Solid light green LED 29: Solid light yellow LED 30: Solid light orange LED 31: Solid light pink LED 32: Solid light purple LED 33: Solid light blue LED 34: Solid light green LED 35: Solid light yellow LED 36: Solid light orange LED 37: Solid light pink LED 38: Solid light purple LED 39: Solid light blue LED 40: Solid light green LED 41: Solid light yellow LED 42: Solid light orange LED 43: Solid light pink LED 44: Solid light purple LED 45: Solid light blue LED 46: Solid light green LED 47: Solid light yellow LED 48: Solid light orange LED 49: Solid light pink LED 50: Solid light purple LED 51: Solid light blue LED 52: Solid light green LED 53: Solid light yellow LED 54: Solid light orange LED 55: Solid light pink LED 56: Solid light purple LED 57: Solid light blue LED 58: Solid light green LED 59: Solid light yellow LED 60: Solid light orange LED 61: Solid light pink LED 62: Solid light purple LED 63: Solid light blue LED 64: Solid light green LED 65: Solid light yellow LED 66: Solid light orange LED 67: Solid light pink LED 68: Solid light purple LED 69: Solid light blue LED 70: Solid light green LED 71: Solid light yellow LED 72: Solid light orange LED 73: Solid light pink LED 74: Solid light purple LED 75: Solid light blue LED 76: Solid light green LED 77: Solid light yellow LED 78: Solid light orange LED 79: Solid light pink LED 80: Solid light purple LED 81: Solid light blue LED 82: Solid light green LED 83: Solid light yellow LED 84: Solid light orange LED 85: Solid light pink LED 86: Solid light purple LED 87: Solid light blue LED 88: Solid light green LED 89: Solid light yellow LED 90: Solid light orange LED 91: Solid light pink LED 92: Solid light purple LED 93: Solid light blue LED 94: Solid light green LED 95: Solid light yellow LED 96: Solid light orange LED 97: Solid light pink LED 98: Solid light purple LED 99: Solid light blue LED 100: Solid light green LED 101: Solid light yellow LED 102: Solid light orange LED 103: Solid light pink LED 104: Solid light purple LED 105: Solid light blue LED 106: Solid light green LED 107: Solid light yellow LED 108: Solid light orange LED 109: Solid light pink LED 110: Solid light purple LED 111: Solid light blue LED 112: Solid light green LED 113: Solid light yellow LED 114: Solid light orange LED 115: Solid light pink LED 116: Solid light purple LED 117: Solid light blue LED 118: Solid light green LED 119: Solid light yellow LED 120: Solid light orange LED 121: Solid light pink LED 122: Solid light purple LED 123: Solid light blue LED 124: Solid light green LED 125: Solid light yellow LED 126: Solid light orange LED 127: Solid light pink LED 128: Solid light purple LED 129: Solid light blue LED 130: Solid light green LED 131: Solid light yellow LED 132: Solid light orange LED 133: Solid light pink LED 134: Solid light purple LED 135: Solid light blue LED 136: Solid light green LED 137: Solid light yellow LED 138: Solid light orange LED 139: Solid light pink LED 140: Solid light purple LED 141: Solid light blue LED 142: Solid light green LED 143: Solid light yellow LED 144: Solid light orange LED 145: Solid light pink LED 146: Solid light purple LED 147: Solid light blue LED 148: Solid light green LED 149: Solid light yellow LED 150: Solid light orange LED 151: Solid light pink LED 152: Solid light purple LED 153: Solid light blue LED 154: Solid light green LED 155: Solid light yellow LED 156: Solid light orange LED 157: Solid light pink LED 158: Solid light purple LED 159: Solid light blue LED 160: Solid light green LED 161: Solid light yellow LED 162: Solid light orange LED 163: Solid light pink LED 164: Solid light purple LED 165: Solid light blue LED 166: Solid light green LED 167: Solid light yellow LED 168: Solid light orange LED 169: Solid light pink LED 170: Solid light purple LED 171: Solid light blue LED 172: Solid light green LED 173: Solid light yellow LED 174: Solid light orange LED 175: Solid light pink LED 176: Solid light purple LED 177: Solid light blue LED 178: Solid light green LED 179: Solid light yellow LED 180: Solid light orange LED 181: Solid light pink LED 182: Solid light purple LED 183: Solid light blue LED 184: Solid light green LED 185: Solid light yellow LED 186: Solid light orange LED 187: Solid light pink LED 188: Solid light purple LED 189: Solid light blue LED 190: Solid light green LED 191: Solid light yellow LED 192: Solid light orange LED 193: Solid light pink LED 194: Solid light purple LED 195: Solid light blue LED 196: Solid light green LED 197: Solid light yellow LED 198: Solid light orange LED 199: Solid light pink LED 200: Solid light purple LED 201: Solid light blue LED 202: Solid light green LED 203: Solid light yellow LED 204: Solid light orange LED 205: Solid light pink LED 206: Solid light purple LED 207: Solid light blue LED 208: Solid light green LED 209: Solid light yellow LED 210: Solid light orange LED 211: Solid light pink LED 212: Solid light purple LED 213: Solid light blue LED 214: Solid light green LED 215: Solid light yellow LED 216: Solid light orange LED 217: Solid light pink LED 218: Solid light purple LED 219: Solid light blue LED 220: Solid light green LED 221: Solid light yellow LED 222: Solid light orange LED 223: Solid light pink LED 224: Solid light purple LED 225: Solid light blue LED 226: Solid light green LED 227: Solid light yellow LED 228: Solid light orange LED 229: Solid light pink LED 230: Solid light purple LED 231: Solid light blue LED 232: Solid light green LED 233: Solid light yellow LED 234: Solid light orange LED 235: Solid light pink LED 236: Solid light purple LED 237: Solid light blue LED 238: Solid light green LED 239: Solid light yellow LED 240: Solid light orange LED 241: Solid light pink LED 242: Solid light purple LED 243: Solid light blue LED 244: Solid light green LED 245: Solid light yellow LED 246: Solid light orange LED 247: Solid light pink LED 248: Solid light purple LED 249: Solid light blue LED 250: Solid light green LED 251: Solid light yellow LED 252: Solid light orange LED 253: Solid light pink LED 254: Solid light purple LED 255: Solid light blue LED 256: Solid light green LED 257: Solid light yellow LED 258: Solid light orange LED 259: Solid light pink LED 260: Solid light purple LED 261: Solid light blue LED 262: Solid light green LED 263: Solid light yellow LED 264: Solid light orange LED 265: Solid light pink LED 266: Solid light purple LED 267: Solid light blue LED 268: Solid light green LED 269: Solid light yellow LED 270: Solid light orange LED 271: Solid light pink LED 272: Solid light purple LED 273: Solid light blue LED 274: Solid light green LED 275: Solid light yellow LED 276: Solid light orange LED 277: Solid light pink LED 278: Solid light purple LED 279: Solid light blue LED 280: Solid light green LED 281: Solid light yellow LED 282: Solid light orange LED 283: Solid light pink LED 284: Solid light purple LED 285: Solid light blue LED 286: Solid light green LED 287: Solid light yellow LED 288: Solid light orange LED 289: Solid light pink LED 290: Solid light purple LED 291: Solid light blue LED 292: Solid light green LED 293: Solid light yellow LED 294: Solid light orange LED 295: Solid light pink LED 296: Solid light purple LED 297: Solid light blue LED 298: Solid light green LED 299: Solid light yellow LED 300: Solid light orange LED 301: Solid light pink LED 302: Solid light purple LED 303: Solid light blue LED 304: Solid light green LED 305: Solid light yellow LED 306: Solid light orange LED 307: Solid light pink LED 308: Solid light purple LED 309: Solid light blue LED 310: Solid light green LED 311: Solid light yellow LED 312: Solid light orange LED 313: Solid light pink LED 314: Solid light purple LED 315: Solid light blue LED 316: Solid light green LED 317: Solid light yellow LED 318: Solid light orange LED 319: Solid light pink LED 320: Solid light purple LED 321: Solid light blue LED 322: Solid light green LED 323: Solid light yellow LED 324: Solid light orange LED 325: Solid light pink LED 326: Solid light purple LED 327: Solid light blue LED 328: Solid light green LED 329: Solid light yellow LED 330: Solid light orange LED 331: Solid light pink LED 332: Solid light purple LED 333: Solid light blue LED 334: Solid light green LED 335: Solid light yellow LED 336: Solid light orange LED 337: Solid light pink LED 338: Solid light purple LED 339: Solid light blue LED 340: Solid light green LED 341: Solid light yellow LED 342: Solid light orange LED 343: Solid light pink LED 344: Solid light purple LED 345: Solid light blue LED 346: Solid light green LED 347: Solid light yellow LED 348: Solid light orange LED 349: Solid light pink LED 350: Solid light purple LED 351: Solid light blue LED 352: Solid light green LED 353: Solid light yellow LED 354: Solid light orange LED 355: Solid light pink LED 356: Solid light purple LED 357: Solid light blue LED 358: Solid light green LED 359: Solid light yellow LED 360: Solid light orange LED 361: Solid light pink LED 362: Solid light purple LED 363: Solid light blue LED 364: Solid light green LED 365: Solid light yellow LED 366: Solid light orange LED 367: Solid light pink LED 368: Solid light purple LED 369: Solid light blue LED 370: Solid light green LED 371: Solid light yellow LED 372: Solid light orange LED 373: Solid light pink LED 374: Solid light purple LED 375: Solid light blue LED 376: Solid light green LED 377: Solid light yellow LED 378: Solid light orange LED 379: Solid light pink LED 380: Solid light purple LED 381: Solid light blue LED 382: Solid light green LED 383: Solid light yellow LED 384: Solid light orange LED 385: Solid light pink LED 386: Solid light purple LED 387: Solid light blue LED 388: Solid light green LED 389: Solid light yellow LED 390: Solid light orange LED 391: Solid light pink LED 392: Solid light purple LED 393: Solid light blue LED 394: Solid light green LED 395: Solid light yellow LED 396: Solid light orange LED 397: Solid light pink LED 398: Solid light purple LED 399: Solid light blue LED 400: Solid light green LED 401: Solid light yellow LED 402: Solid light orange LED 403: Solid light pink LED 404: Solid light purple LED 405: Solid light blue LED 406: Solid light green LED 407: Solid light yellow LED 408: Solid light orange LED 409: Solid light pink LED 410: Solid light purple LED 411: Solid light blue LED 412: Solid light green LED 413: Solid light yellow 														

# Maintenance/ Troubleshooting

Pulstar p100/150 LED indicators, also mirrored as output signals on the User I/O connector, provide status information to the user. Table 6-2 shows Pulstar input/output signal and LED indicator states during normal and fault conditions. User I/O outputs are Closed when the state indicated by the signal name is logically True.

On DC power-up, the RDY lamp illuminates yellow when INT and TMP indicators illuminate green. After the RDY indicator illuminates an internal tickle is enabled. There is a five-second delay before lasing is permitted. When a Shutter Open Request signal is applied; the internal shutter opens, the SHT LED illuminates blue, and application of a PWM Command signal causes the LASE indicator to illuminate red as lasing begins.

For safety reasons, the shutter function on p100/150 lasers is dependent on the state of the Remote Interlock input. The Remote Interlock Input status is reflected by the state of INT and RDY indicators. Although a Shutter Open Request signal may be applied, the SHT LED will not illuminate while the INT LED is red (RDY LED Off). Therefore, no power is applied to the RF boards until the INT indicator is green (and the RDY LED is yellow).

The following section illustrates the dependencies of various operating parameters based on the state of the Remote Interlock input. The conditions shown in bold are those required for lasing to be enabled.

## Possible Causes:

- No voltage is applied to Pin 3 (Remote Interlock) of the User I/O connector.

On systems using remote interlocks, check to see that a positive or negative voltage in the range of  $24 \pm 5$  VDC is applied to Pin 15. For remote Interlocks, with respect to Pin 11 and Input Common on the User I/O Connector please refer to User I/O connections in the Technical Reference chapter for details. For systems not using interlocks, wire a male DB-15 connector to the User I/O connector so that Pin 11 (Input Common) is jumpered to Pin 12 (Auxiliary DC Power Ground) and Pin 15 (Remote Interlock) is jumpered to Pin 4 (+5 VDC Auxiliary Power).

On DC power-up of a p100/150 laser, the RDY lamp illuminates yellow provided INT and TMP indicators illuminate green. Once the RDY indicator illuminates yellow, an internal tickle is enabled and after a five-second period lasing is then permitted. When the Shutter Open Request signal is applied, the internal (EM) shutter opens, the SHT LED illuminates blue, and an application of a PWM Command signal causes the LASE indicator to illuminate red as lasing begins.

## Remote interlock condition

A remote interlock condition occurs when the Remote Interlock input opens. The INT LED is red and the Interlock is closed. The (EM) internal shutter mechanism closes and lasing is halted immediately. On OEM p100/150 lasers, a remote interlock condition is not latched. Re-apply the Remote Interlock signal by reapplying input voltage to that pin and enabling the INT LED to change from red to green. The the interlock (shutter) opens to enable the RDY indicator. Lasing can begin after the five-second delay provided the SHT indicator is illuminated blue and a PWM Command signal is applied.

# Maintenance/ Troubleshooting

## Possible Causes:

- No voltage is applied to Pin 14 (Shutter open) of the User I/O connector.

Verify  $24 \pm 5$  VDC is applied to Pin 14 (Shutter Open Request). For Pin 15 Input Common on the User I/O Connector please refer to the User I/O connections section in the Technical Reference chapter for details. If your system does not provide a Shutter Open Request signal, wire a male DB-15 connector to the User I/O connector so that Pin 15 (Input Common) is jumpered to Pin 12 (Auxiliary DC Power Ground) and Pin 14 (Shutter Open Request) is jumpered to Pin 4 (+5 VDC Auxiliary Power).

When a Shutter Open Request signal is applied to the laser, PWM Command signals are inhibited until the shutter is fully open. It takes approximately 30 ms for the EM shutter to fully open. When the Shutter Open Request signal is removed from Pin 10, PWM Command signals are inhibited immediately even though it takes approximately 120 ms for the EM shutter to fully close. Tickle pulses signals continue to be applied to the RF modules during the close/open EM shutter interval.

## Possible Causes:

- The (Optional) Quick Start Plug or Remote Interlock/Shutter Open Request inputs are not connected to the User I/O connector.

Connect the Quick Start Plug or interlock/shutter input field wiring to the DB-15 User I/O connector. See User I/O connections in the Technical Reference chapter for wiring details.

## Laser fault indications

Pulstar™ p100/150 lasers have the ability to indicate eight specific fault conditions. In the event of certain faults, the RDY LED will blink an error code, pause four seconds, and then repeat the error code. This sequence continues until the fault is corrected and the laser is reset by cycling DC power to the laser. If a No-Strike condition occurs, the SHT LED flashes continuously until the gas breaks down into a plasma state.

Refer to the p100, p150 Input/Output & LED Status Signals table above for a status list, corresponding fault, and description in the comments for basic corrective action.

### **Warning** **Serious** **personal** **injury**



**On Pulstar p100/150 OEM lasers, remote interlock faults are not latched. Clearing the fault condition re-enables the RDY indicator and the laser will fire after the five-second delay provided the SHT indicator is lit and a PWM Command signal is applied. Because exposure to  $10.6 \mu\text{m CO}_2$  laser radiation can inflict severe corneal injuries and seriously burn human tissue, the OEM or System Integrator must ensure that appropriate safeguards are in place to prevent unintended lasing.**

# Maintenance/ Troubleshooting

## Possible Causes:

- Coolant temperature is above 28 °C (82 °F) or there is inadequate coolant flow through the laser. Check that your chiller is maintaining a water temperature between 18 °C–28 °C (64 °F–82 °F) at a flow rate of 7.57 liters per minute (2.0 GPM).

**Note:** OEM lasers can be operated at coolant temperatures up to 28 °C (64 °F to 82 °F) at a flow rate of 11.4 liters per minute (3.0 GPM).

If water temperature is OK, check the flow rate. If a flow meter is not available, disconnect the cooling tubing from the chiller inlet (or the drain) and run the cooling water for 30 seconds into a five-gallon bucket. After 30 seconds, a minimum of 1.5 gallons or (5.8 L) should be collected. If there is less than 1.5 gallons or (5.8 L), check the cooling path for kinked or pinched cooling tubes or check the chiller for a clogged or dirty filter.

On p100/150 lasers, the over-temperature fault is indicated by a red TMP indicator (latched status). If an over-temperature condition occurs, the TMP indicator will turn red, the Fault Detected output will latch, and the RDY indicator light will turn off. Lasing will become disabled. Due to the latched condition, the TMP indicator will remain red even after the laser has cooled sufficiently to begin operation. To reset an over temperature fault, lower coolant temperature below 28 °C and then cycle DC power (remove DC power, wait 30 seconds, reapply DC power). When the RDY indicator illuminates, lasing is enabled after the five-second delay. If the TMP indicator remains red after cycling power, continue to flow cooling water through the laser for a few more minutes and/or verify the coolant flow rate and then cycle DC power again.

## Under Voltage fault

An under voltage fault occurs when DC input voltage falls below a preset limit of 46.5 VDC. This fault is indicated by the RDY LED flashing 1 blink. The Laser Ready output Opens under these conditions. To reset an under voltage fault, first correct the voltage problem and ensure that 48 VDC is measured at the laser's DC power terminals. Next, cycle DC power off and then on again. When the RDY LED illuminates, the Laser Ready output Closes, and lasing is enabled after the five-second delay. Apply a PWM Command signal, provided the SHT indicator is illuminated blue.

## Over Voltage fault

An over voltage fault occurs when DC input voltage rises above a preset limit of 49.5 VDC. This fault is indicated by the RDY LED flashing 2 blinks. Under these conditions the Laser Ready output Opens. To reset an over voltage fault first correct the voltage problem and ensure 48 VDC is measured at the laser's DC power terminals. Next, cycle DC power off and then on again. When the RDY LED illuminates, the Laser Ready output Closes, and lasing is enabled (after a five-second delay) provided a PWM Command signal is applied, and the SHT indicator is illuminated blue.

# Maintenance/ Troubleshooting

## RF Drive Switch fault

An RF Drive Switch fault occurs during power-up. RF drive switch faults are triggered by either of the following: the tube fails to breakdown, or the RF Driver's 48-volt switching circuitry fails. A RF drive switch fault is indicated when the RDY LED flashes 3 blinks and the Laser Ready output Closes. If a RF Drive Switch fault occurs, the laser requires service—Contact SYNRAD® Customer Service or a SYNRAD Authorized Distributor.

## PWM Drive fault

A PWM Drive fault signals a problem in the laser's internal RF circuitry and is indicated by a flashing RDY LED that blinks 4 times. If a PWM Drive fault appears, the laser requires service—please contact SYNRAD Customer Service or a SYNRAD Authorized Distributor.

## DC Pre-Charge fault

A DC Pre-Charge fault indicates that 48 VDC is not available at the input of one or more of the RF modules. The RDY LED will flash in a 5 blink pattern. When this occurs, the Laser Ready output Opens. If a DC Pre-Charge fault appears, the laser requires service—please contact SYNRAD Customer Service or a SYNRAD Authorized Distributor.

## No-Strike fault

A No-Strike fault occurs when the laser discharge does not strike (gas does not breakdown). During No-Strike faults lasing is limited to a maximum 6.25% duty cycle (at a PWM Command frequency of 5 kHz), or 5% at the user's specified frequency during PWM signal application. In addition to the SHT indicator flashing continuously an error message appears on the p100/150's web page.

## Humidity fault

During laser operation, monitor information on the p100/150's web page including the relative humidity (RH) value. When properly conditioned purge gas is flowing, the measured RH value should drop below 10% within 10-15 minutes. If the RH value doesn't drop below approximately 10% increase the gas flow rate to the maximum specified value. Refer to purge gas specifications in the Getting Started chapter within the connection section. If the RH value continues to rise and reach 95%, lasing is halted. See the prior p100, p150 Input/Output & LED Status Signals table.

## Blinking Shutter LED fault

### Possible Causes:

- A No-Strike fault has occurred, possibly due to cold environmental conditions (common when overnight temperatures are low) that may prevent the gas from breaking down into a plasma state.

# Maintenance/ Troubleshooting

When this occurs, it may take 30 to 60 seconds for gas breakdown so the laser can begin normal daily operation. There are three methods to force breakdown and clear the no-strike fault: (1) Apply tickle pulses or a PWM Command signal ( $\leq 6.25\%$  duty cycle) for 30 to 60 seconds. When the gas breaks down into a plasma state, the laser will recover and begin lasing at the commanded power level without cycling DC power. (2) Apply a single 20  $\mu\text{s}$  PWM pulse (at 5 kHz) while monitoring the Fault Detected output. If the output closes, wait a minimum of 52 ms for the output to open and then apply another 20  $\mu\text{s}$  PWM pulse. Repeat this sequence until no fault is detected—which typically occurs in less than one second. Be aware that applying 20  $\mu\text{s}$  breakdown pulses in rapid succession may cause laser output. (3) Apply a PWM Command signal (at  $< 5\%$  duty cycle) until the fault clears—typically less than 30 seconds. With either method, when breakdown does occur, lasing will begin immediately at the commanded PWM parameters without cycling DC power. If the No-Strike condition persists, contact SYNRAD® or a SYNRAD Authorized Distributor.

## Frequency Limit fault

### Possible Causes:

- The 100 kHz PWM frequency limit has been exceeded.

Lasing is disabled when the input frequency limit is exceeded. When the input drops below 100 kHz, the laser will begin lasing immediately at the commanded PWM parameters without cycling DC Power.

## Duty Cycle/Pulse Width Limit fault

### Possible Causes:

- The applied PWM Command signal is outside the laser's operating parameters.

Lasing is disabled when a constant 5V signal (100% duty cycle) is applied. When the PWM duty cycle drops below 100%, the laser will begin lasing immediately at its 50% PWM duty cycle limit. If the commanded duty cycle is above 50% or the PWM pulse length exceeds 1000  $\mu\text{s}$ , adjust the pulse length until the PWM input is brought within limits. The laser will then lase at the commanded PWM parameters.

When a duty cycle or pulse width limit fault is detected, the SHT LED flashes 3 blinks and the Fault Detected output Closes to indicate (1) a constant 5V PWM signal is applied, forcing the PWM duty cycle to 100%—full continuous wave operation; (2) the applied duty cycle is above the 37.5% limitation; or (3) the applied pulse length exceeds 1000  $\mu\text{s}$  in duration. When condition 1 occurs, the laser begins lasing immediately at 50% once the PWM duty cycle drops below 100%. For condition 2, the laser begins lasing immediately at the commanded PWM parameters, the duty cycle is automatically limited to 50%. For condition 3, the laser begins lasing immediately at the commanded PWM parameters, the pulse duration is automatically limited to 600  $\mu\text{s}$ .



# Maintenance/ Troubleshooting

## Cleaning optical components

Debris or contaminants on external beam delivery components may affect laser processing and lead to damage or failure of the optics and/or the laser. Please refer to the Optics Cleaning and Inspection within section 4 inside this Service Manual.

### **Caution** Possible Equipment Damage



Even small amounts of contamination on optics in the beam path can absorb enough energy to damage the optic. Inspect beam delivery optics periodically for signs of contaminants and carefully clean as required. In dirty environments, purge laser optics using filtered air or nitrogen to prevent vapor and debris from accumulating on optical surfaces.

**Important** – Pulstar™ p100/150 lasers have several beam conditioning optics between the output aperture and the faceplate. To prevent dust and debris from damaging these optical surfaces, always connect nitrogen or filtered air to the laser's *Gas Purge* port.

### **Warning**

### **Serious personal injury**



**Ensure that DC power to the laser is turned off and locked out before inspecting optical components in the beam path.**

**Invisible CO<sub>2</sub> laser radiation is emitted through the aperture. Corneal damage or blindness may result from exposure to laser radiation.**

**A risk of exposure to toxic elements, like zinc selenide, may result when certain optical or beam delivery components are damaged. In the event of damage to laser, marking head, or beam delivery optics, contact SYNRAD®, or the optics manufacturer for handling instructions.**

# Maintenance/ Troubleshooting

## Symptom:

- The laser loses power over time; laser output power must be increased to maintain performance.

## Possible Causes:

- Beam delivery optics are coated by vapor residue or debris.

Shut down the laser and carefully inspect each optic in the beam delivery path. If the optic requires cleaning, refer back to Maintenance for cleaning instructions. Use only recommended cleaning materials (see Table 3-1) to prevent scratching delicate optical surfaces. If the focusing optic is pitted, it must be replaced immediately. Because of the extremely high power density of Pulstar™ lasers, pits or debris on the lens surface may absorb enough energy from the focused beam to crack the lens. If this happens, other optics in the beam path may be contaminated or damaged as well.

When the application requires air (instead of nitrogen) as an assist gas, we recommend the use of breathing quality air available in cylinders from a welding supply company. Because compressed shop air contains minute particles of oil and other contaminants that will damage optical surfaces, it must be carefully filtered and dried before use as a purge or assist gas. Refer to the purge gas specifications, in the Introduction chapter of this manual and the getting started chapter in the Operation Manual for filtering and drying specifications.

# Tables and Figures

# index

## Symbols

- +5 VDC Auxiliary Power 53
- +5 VDC output 55
  - signal description, 55
- +24 VDC 63
- +24 VDC Auxiliary Power 53
- +24 VDC output 55
  - signal description, 55

## A

- American National Standards Institute (ANSI) 18
- Assist gas purity
  - specifications, 31, 40, 44
- Aux. DC Power Ground 55
  - signal description, 55
- Auxiliary DC power 55
  - +5 VDC, 55, 56
  - +24 VDC 55
  - +24 VDC, 55
  - Aux. DC Power Ground 55
  - Aux. DC Power Ground, 55
  - internal wiring diagram, 55
- Auxiliary DC Power Ground
  - pin description, 54

## C

- Caution
  - condensation, 5, 30, 34, 76, 77, 78, 80, 81, 89
  - single-phase operation, 52, 65
- CDRH 22
- Class IV safety features 25
- Code of Federal Regulations (CFR) 22, 23
- Collimator 35
- Command signal 43, 51
  - base frequency, 43
  - duty cycle, 43
- Condensation damage 77
- Contact information
  - European headquarters, 8
- Control signals 42–43
  - Tickle pulse, 42
- Copyright information 6
- Customer Service 8

## D

- Daily inspections 77
- Danger
  - laser radiation, 15, 16, 17, 18, 77, 78, 81, 85, 89
- DC Power cable 77
- DC Power Cables 65
- Delivery optics 35
- Disabling Firestar 77

## E

- European headquarters 8

Expander/collimator 35

## F

- Flowchart
  - laser start-up, 82
- Flow rate 86
- Food and Drug Administration (FDA) 22

## H

- Hazard information 16
  - label locations, 20, 21
  - terminology, 16

## I

- Input circuit
  - equivalent schematic, 58
  - specifications, 58
- Input Common 57
  - pin description, 54
- Input signals
  - PWM Return, 56
  - Remote Interlock, 56
- Inspections
  - daily, 77
- Interlock Open
  - pin description, 54, 60

## K

- Keystwitch functions
  - integrating, 66

## L

- Label locations 20, 21
- Laser Active 53
  - pin description, 59
- Laser Institute of America (LIA) 19
- Laser Ready 59
  - pin description, 54, 59

## M

- Maintenance
  - daily inspections, 77
  - disabling Firestar, 77
  - storage/shipping, 78
- MSDS 79

## O

- Occupational Safety and Health Administration (OSHA) 19
- Output circuit
  - equivalent schematic, 60
  - specifications, 60
- Output Common 41, 42, 59, 64, 67
  - pin description, 54, 59
- Output signals

# index

Laser Ready, 59  
Output Common, 59  
Over Temperature, 59  
Over Temperature 59  
Over Temperature output 86

## P

PLC  
multiple inputs, 64  
multiple outputs, 62  
Remote Interlock output, 62  
PWM  
signal levels, 50  
PWM Input 43, 56  
pin description, 54  
PWM Input signal  
description, 56  
specifications, 58  
PWM Return 43, 53, 56  
PWM Return signal  
description, 56

## Q

Quick Start Plug  
wiring diagram, 57

## R

Ready indicator 86  
Reference materials 8  
Remote Interlock 53, 56  
customer-supplied circuit, 61  
from PLC, 62  
Remote Interlock functions 67  
Remote Interlock indicator 67  
Remote Interlock input 66, 67, 84  
Remote Interlock (INT) indicator 84  
Remote Interlock signal  
specifications, 58  
Remote Reset/Start Request 53, 56  
Remote Reset/Start Request signal  
specifications, 58  
RoHS 24

## S

Sales and Applications 8  
Shutter Open  
pin description, 54, 59  
Shutter Open request  
pin description, 54  
Shutter Open Request 57  
Shutter Open Request signal  
specifications, 58  
Specifications  
assist gas purity, 31, 40, 44  
Storage/shipping 78

## T

Technical overview  
laser tube, 31  
Technical Support 8  
Temp indicator 86  
Tickle pulse 42  
Trademark information 6  
Troubleshooting 79  
operational flowchart, 82

## U

User I/O  
connection summary, 52  
pin descriptions, 53, 55  
User I/O connections 52  
input/output signals 52  
sample input circuits, 61  
User I/O connector 66, 67, 84

## W

Warning  
air contaminants, 5, 6, 29, 30, 34  
Warranty information 7