

32-1 Operator's Manual



SYNRAD[®]

A Novanta Company

4600 Campus Place
Mukilteo, WA 98275

1.800.SYNRAD1

tel 1.425.349.3500

fax 1.425.349.3667

e-mail synrad@synrad.com

web www.synrad.com

32-1 Operator's Manual

Model 32-1

Version 2.4

SYNRAD is a registered trademark of Novanta Corporation. ©Novanta Corporation 2018. All Rights Reserved. No reproduction without written authorization.

DATE: July 2019

Table of contents

Introduction 1

Figure 2-2 Always wear safety glasses.	18
Figure 2-3 38-1 Hazard label locations.	20
Table 2-1 Class 4 safety features as required by CDRH and EN.	24
Table 2-2 European Union Directives.	25
Figure 2-5 32-1 Declaration Document.	26

Laser Safety 2

Laser Safety.....	14
Hazard Information	15
Terms.....	15
General Hazards	17
Additional laser safety information	19
32-1 label locations.....	20
Compliance.....	21
Center for Devices and Radiological Health (CDRH) requirements.....	21
European Union (EU) requirements.....	23
OEM models.....	23
Electromagnetic interference standards	23

Operation 3

Controls and Indicators	28
32-1 front panel	28
32-1 rear panel	28
Side panel.....	29

Technical Reference 4

Technical reference summary.....	27
Technical overview	28
Introduction	28
Plasma section.....	28
Optical resonator.....	28
Controlling Circuitry.....	29
Cooling.....	30
Optical setup.....	30
Control signals.....	33
Operating modes	38
UC-2000 Universal Laser Controller.....	39
Continuous wave (CW) operation.....	39
DB-9 connections.....	41
User I/O connections.....	42
I/O Fault Diagrams	43

Table of contents

Technical Reference 4

Sample DB-9 Connector I/O circuits45
Sample output circuits46
Integrating 32-1 safety features47
General Specifications48
Outline and Mounting Diagrams.....49

Maintenance & Troubleshooting 5

Maintenance and Troubleshooting50
Introduction50
Maintenance51
Disabling the 32-1 laser51
Daily inspections51
Storage/shipping.....52
Cleaning guidelines.....53
Cleaning optics54
Troubleshooting55
Troubleshooting Introduction.....55
Beam delivery optics.....56
Possible Causes:56
Input/Output/Fault Conditions.....57

Index

Index58

Introduction

1

Introduction

- Trademark, Copyright & Warranty information
- Guidelines and contents description
- 32-1 Nomenclature

Important Note:



This Operation Manual explains operation activities related to 32-1 lasers. If you cannot operate the unit using the information described in this manual, contact SYNRAD® (+1.425.349.3500) or an authorized SYNRAD Distributor.

Do not lift or support the laser by its cooling fittings.

Failure to properly package the laser using SYNRAD shipping box and foam/cardboard inserts as shown in Packaging Instructions may void the warranty. Customers may incur additional repair charges due to shipping damage caused by improper packaging.

Before beginning any maintenance or inspections of your 32-1 laser, be sure to completely disable the laser by disconnecting the DC Power cable (or cables) from the rear of the laser.

Caution Possible Equipment Damage



SYNRAD does not recommend vertical or head down configurations.

Please contact the factory for limitations as a vertical orientation increases the risk of damage to the lasers optics.

A **risk of exposure** to toxic elements may result when certain optical or beam delivery components are damaged. In the event of damage to laser, marking head, or beam delivery optics, contact SYNRAD®, or the optics manufacturer for handling instructions.

If you **operate your laser dirty or dusty environments**, contact SYNRAD about the risks of doing so and precautions you can take to increase the longevity of your laser, marking head, and associated optical components.

Introduction

Trademark/copyright information

Trademark, Warranty & Copyright Information

SYNRAD® and 32-1 are registered trademarks of SYNRAD.

All other trademarks or registered trademarks are the property of their respective owners.

2018 by SYNRAD.
All rights reserved.

Introduction

Warranty information

This is to certify that 32-1 lasers are guaranteed by SYNRAD® to be free of all defects in materials and workmanship for one year from the date of shipment. This warranty does not apply to any defect caused by negligence, misuse (including environmental factors), accident, alteration, or improper maintenance. This includes, but is not limited to, damage due to corrosion, condensation, or failing to supply properly conditioned purge gas.

We request that you examine each shipment within 10 days of receipt and inform SYNRAD of any shortage or damage. If no discrepancies are reported, SYNRAD shall assume the shipment was delivered complete and defect-free.

If, within one year from the date of shipment, any part of the 32-1 laser should fail to operate, contact the SYNRAD Customer Service department at 1.800.SYNRAD1 (outside the U.S. call 1.425.349.3500) and report the problem. When calling for support, please be prepared to provide the date of shipment, model number and serial number of the unit, and a brief description of the problem. When returning a unit for service, a Return Authorization (RA) number is required; this number must be clearly marked on the outside of the shipping container in order for the unit to be properly processed. If replacement parts are sent to you, then you are required to send the failed parts back to SYNRAD for evaluation unless otherwise instructed.

If your 32-1 laser fails within the first 45 days after shipment, SYNRAD will pay all shipping charges to and from SYNRAD when shipped as specified by SYNRAD Customer Service. After the first 45 days, SYNRAD will continue to pay for the costs of shipping the repaired unit or replacement parts back to the customer from SYNRAD. The customer, however, will be responsible for shipping charges incurred when sending the failed unit or parts back to SYNRAD or a SYNRAD Authorized Distributor. In order to maintain your product warranty and to ensure the safe and efficient operation of your 32-1 laser, only authorized SYNRAD replacement parts can be used. This warranty is void if any parts other than those provided by SYNRAD are used.

SYNRAD and SYNRAD Authorized Distributors have the sole authority to make warranty statements regarding SYNRAD products. SYNRAD and its Authorized Distributors neither assumes nor authorizes any representative or other person to assume for us any other warranties in connection with the sale, service, or shipment of our products. SYNRAD reserves the right to make changes and improvements in the design of our products at any time without incurring any obligation to make equivalent changes in products previously manufactured or shipped. Buyer agrees to hold SYNRAD harmless from any and all damages, costs, and expenses relating to any claim arising from the design, manufacture, or use of the product, or arising from a claim that such product furnished buyer by SYNRAD, or the use thereof, infringes upon any Patent, foreign or domestic.

Introduction

Sales, Application, & Support

SYNRAD Sales & Support

SYNRAD Headquarters

SYNRAD® worldwide headquarters are located north of Seattle in Mukilteo, Washington. U.S.A. Our mailing address is:

SYNRAD
4600 Campus Place
Mukilteo, WA 98275
U.S.A.

Phone us at: 1.800.SYNRAD1 (1.800.796.7231)
Outside the U.S.: +1.425.349.3500
Fax: +1.425.349.3667
E-mail: synrad@synrad.com

Sales and Applications

SYNRAD Regional Sales Managers work with customers to identify and develop the best CO₂ laser solution for a given application. Because they are familiar with you and your laser application, use them as a first point of contact when questions arise. Regional Sales Managers also serve as the liaison between you and our Applications Lab in processing material samples per your specifications. To speak to the Regional Sales Manager in your area, call SYNRAD at 1.800.SYNRAD1.

Customer Service

For assistance with order or delivery status, service status, or to obtain a Return Authorization (RA) number, contact SYNRAD at 1.800.SYNRAD1 and ask to speak to a Customer Service representative, or you can email us by sending a message to customercare@synrad.com.

Technical Support

SYNRAD Regional Sales Managers are able to answer many technical questions regarding the installation, use, troubleshooting, and maintenance of our products. In some cases, they may transfer your call to a Laser, Marking Head, or Software Support Specialist. You may also e-mail questions to the Technical Support Group by sending your message to synradtechsupport@synrad.com.

Reference materials

Your Regional Sales Manager can provide reference materials including Outline & Mounting drawings, Operator's Manuals, Technical Bulletins, and Application Newsletters. Most of these materials are also available directly from the SYNRAD web site at <http://www.synrad.com>.

Introduction

European headquarters

For assistance in Europe, contact SYNRAD® at:

©Novanta Distribution (USD) GmbH
Parkring 57-59
85748 Garching bei München, Germany

Phone: +49 89 31707-0

Fax: +49 (0) 89 31707-222

E-mail: service-europe@synrad.com

web: www.synrad.com

For assistance in China, contact SYNRAD® at:

©Novanta SYNRAD China Sales and Service Center
2401-J, Bak Building, Hi-tech Park, Nanshan District
Guangdong, PRC 518057

Phone: +86 (755) 8280 5395

Fax: +86 (755) 8672 1125

E-mail: sales-china@synrad.com

web: www.synrad.com

Introduction

Guidelines & Content Description

Guidelines & Content

See the drawings within this Operation Manual when installing and operating your 32-1 laser.

- Unpacking/Packing, Storage/Shipping, Mounting, Connecting, Cooling
- 32-1 Nomenclature/Features

Unpacking/packing, storage/shipping, mounting, connecting, cooling

SYNRAD® recommends saving all of the laser's original packaging. It's unique design assists in preventing damage to your laser during storage, relocation and/or shipping. Additional information can also be found in the Technical Reference chapter within this manual.

Contents description

Each item below is also listed in tables that follow:

SYNRAD OEM 32-1 Laser – for cutting, welding, drilling, and marking a wide variety of products and materials.

Customer Communication Flier – Instead of the laser manual CD, please follow the instructions for our latest laser manual(s) located here: <http://synrad.com/synrad/docroot/resources/libraries/manuals>.

Spare Fuse- Fuses protect internal circuitry. A 10 A fuse is included with our 32-1 lasers.

Final Test Report (not shown) – Contains data collected during the laser's final pre-shipment test.

Introduction

Guidelines & Content Description

SYNRAD® CO₂
Web Flier

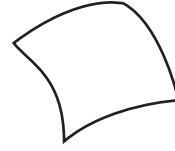

Spare Fuse(s)

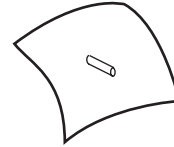

Figure 1-1 32-1 Ship kit contents.

Table 1-1 32-1 ship kit contents.

Shipping Box Contents	Qty	Shipping Box Contents	Qty
32-1 Laser	1	Mounting Bolts	3
Customer flier	1	Final Test Report (not shown)	1
Spare Fuses	(As Required)		

Introduction

Guidelines & Content Description

32-1 nomenclature

The 32-1 nomenclature section includes:

- Model numbers

- 32-1 laser versions

The last three characters in the 32-1 model number serve to designate the functional category, cooling method, and model version. The functional category is indicated by a "S" for Standard (OEM) models. The next letter indicates the cooling method: "A" for air-cooled lasers (where the customer must provide the proper cooling via fans or blowers). OEM and Air cooled models are the only options available for the 32-1. The last letter in the model number indicates the current model version "C". For example, the model number 32-1 SAC designates the 32-1 laser as a Standard OEM, Air-cooled version C.

Introduction

Features & Nomenclature

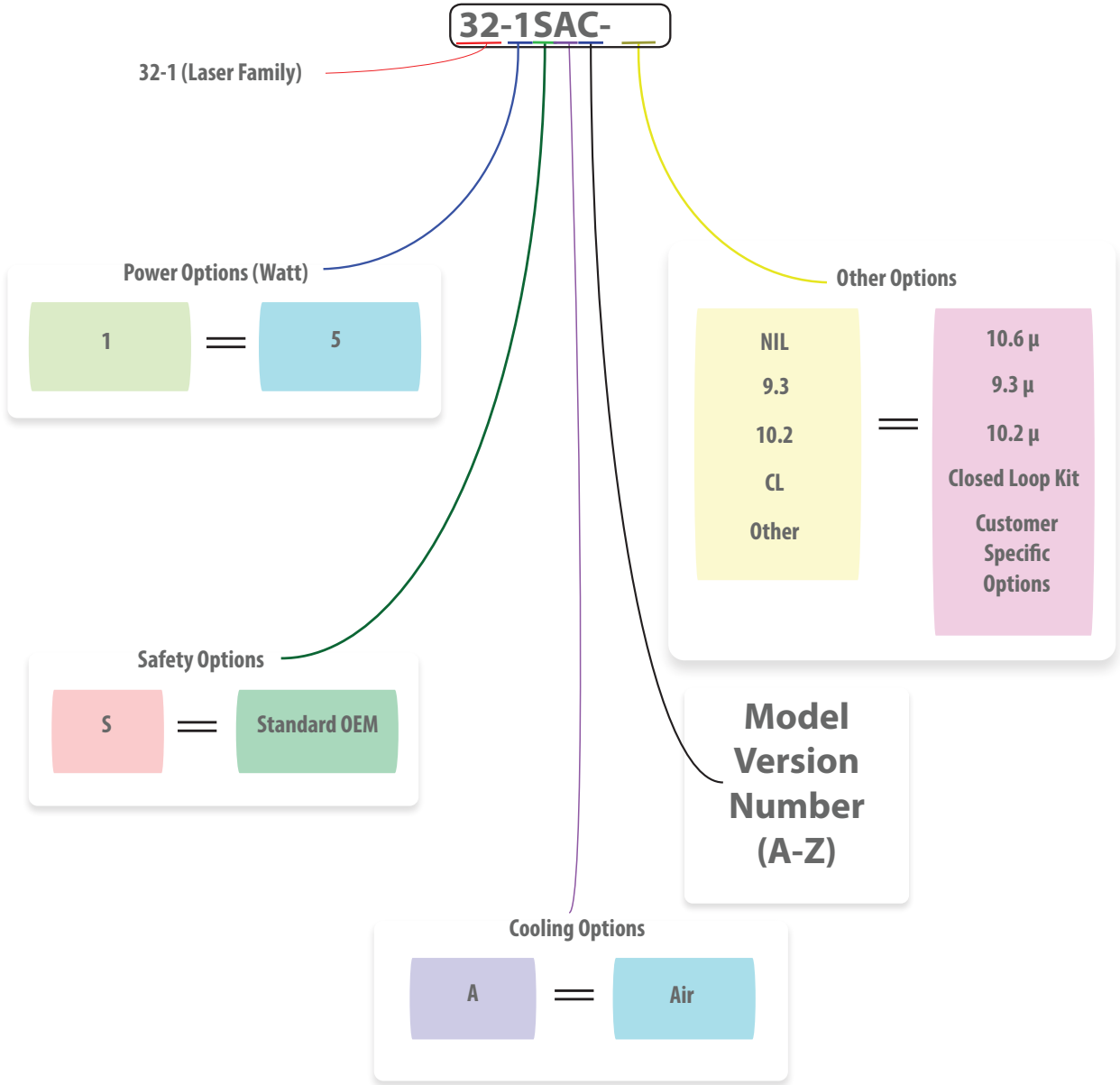

Figure 1-2 Anatomy of a model number.

Laser Safety

2

Laser Safety

- Hazard Information – includes equipment label terms and hazards, please familiarize yourself with all definitions and their significance.
- General & Other Hazards – provides important information about the hazards and unsafe practices that could result in death, severe injury, or product damage.
- Disposal – information on your 32-1 laser parts and/or components as they pertain to disposal.
- Additional safety Information – describes how to find additional information about your 32-1 laser.
- Compliance – explains in the subsections therein applicable and appropriate regulation information.

Note: Read the entire safety section. This will ensure you are familiar with the hazards and warnings prior to starting.

Warning Serious personal injury



Although the 32-1 wavelength is 10.6 microns (μm) any Class 4 laser product that emits invisible infrared laser radiation in the 9.3–10.6 μm CO₂ wavelength band is capable of seriously burning human tissue.

Because direct or diffuse laser radiation can inflict severe corneal injuries, always wear eye protection when in the same area as an exposed laser beam.

Do not allow the laser beam to contact a person!

This product emits an invisible laser beam that is capable of seriously burning human tissue.

Always be aware of the beam's path and always use a beam block while testing.

Laser Safety

Warning Serious personal injury



For laser systems being used or sold within the U.S.A., customers should refer to and follow the laser safety precautions described in American National Standards Institute (ANSI) document Z136.1-2007, Safe Use of Lasers.

For laser systems being used or sold outside the U.S.A., customers should refer to and follow the laser safety precautions described in European Normative and International Electrotechnical Commission documents IEC/TR 60825-14:2004, Safety of Laser Products – Part 14: A User's Guide.

Hazard Information

Hazard information includes terms, symbols, and instructions used in this manual or on the equipment to alert both operating and service personnel to the recommended precautions in the care, use, and handling of Class 4 laser equipment.

Terms

Certain terms are used throughout this manual or on the equipment labels. Please familiarize yourself with their definitions and significance.

- Imminent hazards which, if not avoided, will result in death or serious injury.
- Potential hazards which, if not avoided, could result in death or serious injury.
- Hazards which, if not avoided, could result in minor or moderate injury.
- Caution- potential hazards or unsafe practices which, if not avoided, may result in product damage.
- Important information or recommendations concerning the subject under discussion.

Laser Safety



Parameter	Description
	<p>WARNING: Potential & Imminent hazards which, if not avoided, could result in death or serious injury.</p> <p>Alerts operator of serious dangers, hazardous radiation, hazardous voltages, vapor hazard, & reflective dangers.</p>
	<p>DANGER: Hazards which, if not avoided, could result in minor or moderate injury.</p> <p>Alerts operator of lifting dangers.</p>
	<p>CAUTION: Potential hazards or unsafe practices which, if not avoided, may result in product damage.</p> <p>Alerts operator of equipment dangers.</p>
	<p>IMPORTANT NOTES & TIPS:</p> <p>Content specific information and/or recommendations.</p>

Figure 2-1 Warning, danger, caution and content specific information icons and definitions.

Laser Safety

General Hazards

Following are descriptions of general hazards and unsafe practices that could result in death, severe injury, or product damage. Specific warnings and cautions not appearing in this section are found throughout the manual.

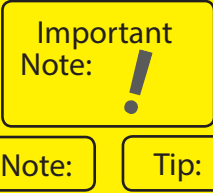
Warning

Serious
personal
injury



Do not allow laser radiation to enter the eye by viewing direct or reflected laser energy. CO₂ laser radiation can be reflected from metallic objects even though the surface is darkened. Direct or diffuse laser radiation can inflict severe corneal injuries leading to permanent eye damage or blindness. All personnel must wear eye protection suitable for 9.3–10.6 μm CO₂ radiation when in the same area as an exposed laser beam. Eye wear protects against scattered energy but is not intended to protect against direct viewing of the beam—never look directly into the laser output aperture or view scattered laser reflections from metallic surfaces.

Enclose the beam path whenever possible. Exposure to direct or diffuse CO₂ laser radiation can seriously burn human or animal tissue, which may cause permanent damage.

This product is not intended for use in explosive, or potentially explosive, atmospheres.

Materials processing with a laser can generate air contaminants such as vapors, fumes, and/or particles that may be noxious, toxic, or even fatal.

Material Safety Data Sheets (MSDS) for materials being processed should be thoroughly evaluated and the adequacy of provisions for fume extraction, filtering, and venting should be carefully considered. Review the following references for further information on exposure criteria:

Review the following references for further information on exposure criteria:

ANSI Z136.1-2007, Safe Use of Lasers, section 7.3.

U.S. Government's Code of Federal Regulations: 29 CFR 1910, Subpart Z.

Threshold Limit Values (TLV's) published by the American Conference of Governmental Industrial Hygienists (ACGIH).

It may be necessary to consult with local governmental agencies regarding restrictions on the venting of processing vapors.

The use of aerosol dusters containing difluoroethane causes "blooming", a condition that significantly expands and scatters the laser beam. This beam expansion can effect mode quality and/or cause laser energy to extend beyond the confines of optical elements in the system, possibly damaging acrylic safety shielding. Do not use air dusters containing difluoroethane in any area adjacent to CO₂ laser systems because difluoroethane persists for long time periods over wide areas.

Laser Safety

32-1 lasers should be installed and operated in manufacturing or laboratory facilities by trained personnel only. Due to the considerable risks and hazards associated with the installation and operational use of any equipment incorporating a laser, the operator must follow product warning labels and instructions to the user regarding laser safety. To prevent exposure to direct or scattered laser radiation, follow all safety precautions specified throughout this manual and exercise safe operating practices per ANSI Z136.1-2007, Safe Use of Lasers at all times when actively lasing.

Due to the specific properties of laser light, a unique set of safety hazards that differ from other light sources must be considered. Just like light, lasers can be reflected, refracted, diffracted or scattered.

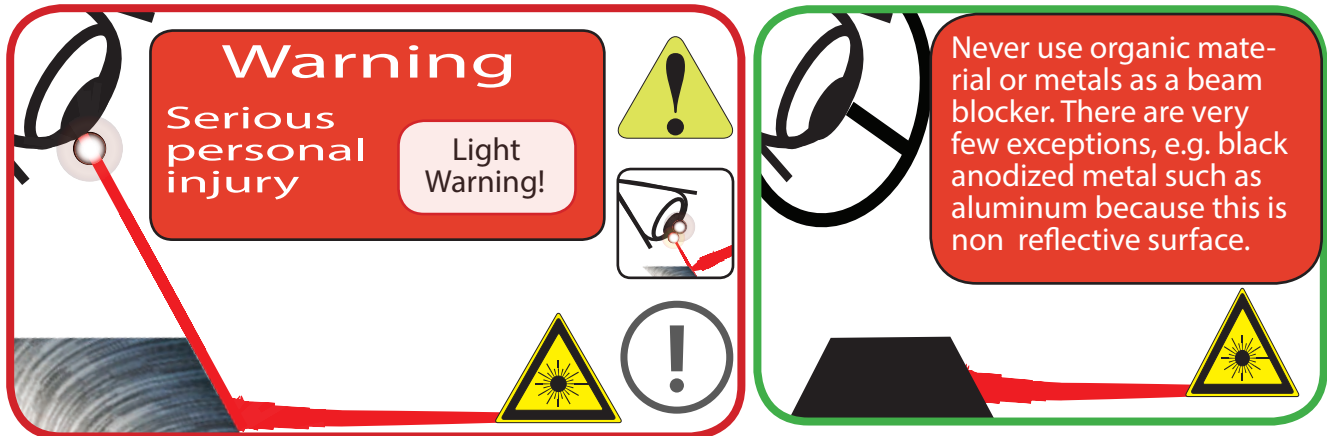



Figure 2-2 Always wear safety glasses or protective goggles with side shields to reduce the risk of damage to the eyes when operating the laser.

A CO₂ laser is an intense energy source and will ignite most materials under the proper conditions. Never operate the laser in the presence of flammable or explosive materials, gases, liquids, or vapors.

Important Note:  - The use of controls or adjustments or performance of procedures other than those specified herein may result in hazardous radiation exposure."

The use of controls or adjustments or performance of procedures other than those specified herein may result in exposure to hazardous invisible laser radiation, damage to, or malfunction of the laser. Severe burns will result from exposure to the laser beam.

Safe operation of the laser requires the use of an external beam block to safely block the beam from traveling beyond the desired work area. Do not place your body or any combustible object in the path of the laser beam. Use a water-cooled beam dump or power meter, or similar non-scattering, noncombustible material as the beam block. Never use organic material or metals as the beam blocker; organic materials, in general, are apt to combust or melt and metals act as specular reflectors which may create a serious hazard outside the immediate work area.

Always wear safety glasses or protective goggles with side shields to reduce the risk of damage to the eyes when operating the laser.

Laser Safety

Disposal

This product contains components that are considered hazardous industrial waste. If a situation occurs where the laser is rendered non-functional and cannot be repaired, it may be returned to SYNRAD® who, for a fee, will ensure adequate disassembly, recycling and/or disposal of the product.

Other hazards

The following hazards are typical for this product family when incorporated for intended use: (A) risk of injury when lifting or moving the unit; (B) risk of exposure to hazardous laser energy through unauthorized removal of access panels, doors, or protective barriers; (C) risk of exposure to hazardous laser energy and injury due to failure of personnel to use proper eye protection and/or failure to adhere to applicable laser safety procedures; (D) risk of exposure to hazardous or lethal voltages through unauthorized removal of covers, doors, or access panels; (E) generation of hazardous air contaminants that may be noxious, toxic, or even fatal.

Additional laser safety information

The SYNRAD web site (<http://www.synrad.com/LaserFacts/safetyinfo.html>) contains an online laser safety handbook that provides information on (1) Laser Safety Standards for OEM's/System Integrators, (2) Laser Safety Standards for End Users, (3) References and Sources, and (4) Assistance with Requirements.

In addition, the Occupational Safety and Health Administration (OSHA) provides an online Technical Manual (located at http://www.osha.gov/dts/osta/otm/otm_iii/otm_iii_6.html). Section III, Chapter 6 and Appendix III are good resources for laser safety information.

Another excellent laser safety resource is the Laser Institute of America (LIA). Their comprehensive web site is located at <http://www.lia.org>.



32-1 label locations

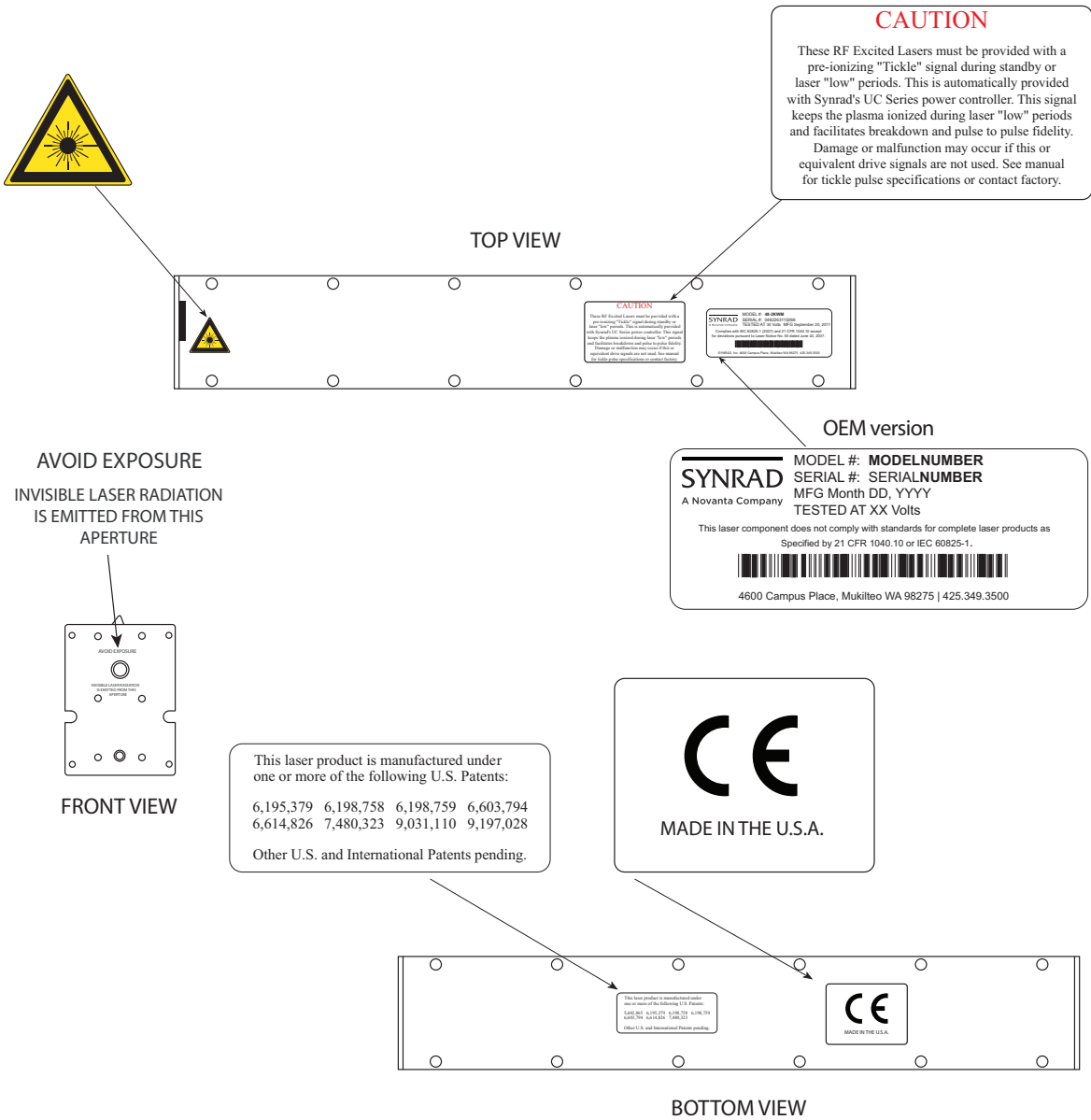

Figure 2-3 38-1 Hazard label locations.

Compliance

- Center for Devices and Radiological Health (CDRH) requirements.
- Federal Communications Commission (FCC) requirements.
- European Union (EU) requirements.

SYNRAD® lasers are designed, tested, and certified to comply with certain United States (U.S.) and European Union (EU) regulations. These regulations impose product performance requirements related to electromagnetic compatibility (EMC) and product safety characteristics for industrial, scientific, and medical (ISM) equipment. The specific provisions to which systems containing 32-1 lasers must comply are identified and described in the following paragraphs.

In the U.S., laser safety requirements are governed by the Center for Devices and Radiological Health (CDRH) under the auspices of the U.S. Food and Drug Administration (FDA) while radiated emission standards fall under the jurisdiction of the U.S. Federal Communications Commission (FCC). Outside the U.S., laser safety and emissions are governed by European Union (EU) Directives and Standards.

In the matter of CE-compliant laser products, SYNRAD assumes no responsibility for the compliance of the system into which the product is integrated, other than to supply and/or recommend laser components that are CE marked for compliance with applicable European Union Directives.

Because OEM laser products are intended for incorporation as components in a laser processing system, they do not meet all of the Standards for complete laser processing systems as specified by 21 CFR, Part 1040 or EN 60825-1. SYNRAD assumes no responsibility for the compliance of the system into which OEM laser products are integrated.

Center for Devices and Radiological Health (CDRH) requirements

Product features incorporated into the design of 32-1 lasers to comply with CDRH requirements are integrated as panel controls or indicators, internal circuit elements, or input/output signal interfaces. Specifically, these features include a lase and laser ready indicators, remote interlock for power on/off, a laser aperture shutter switch, and a five-second delay between power on and lasing. Incorporation of certain features is dependent on the laser version (Key-switch or OEM). See the Class 4 safety features, located in the following table, that indicate which features are available on 32-1 lasers, the type and description of the feature, and if the feature is required by CDRH regulations.

OEM models

32-1 OEM lasers are OEM products intended for incorporation as components in laser processing systems. As supplied by SYNRAD, these lasers do not meet the requirements of 21 CFR, Subchapter J without additional safeguards. In the U.S., the Buyer of these OEM laser

components is solely responsible for the assurance that the laser processing system sold to an end user complies with all laser safety requirements before the actual sale of the system. Under CDRH regulations, the Buyer must submit a report to the CDRH prior to shipping the system. In jurisdictions outside the U.S., it is the sole responsibility of the Buyer of these OEM

(FCC) requirements

The United States Communication Act of 1934 vested the Federal Communications Commission (FCC) with the authority to regulate equipment that emits electromagnetic radiation in the radio frequency spectrum. The purpose of the Communication Act is to prevent harmful electromagnetic interference (EMI) from affecting authorized radio communication services. The FCC regulations that govern industrial, scientific, and medical (ISM) equipment are fully described in 47 CFR, Part 18, Subpart C.

SYNRAD® 32-1 lasers have been tested and found to comply by demonstrating performance characteristics that have met or exceeded the requirements of 47 CFR, Part 18, Radiated and Conducted Emissions.

FCC information to the user

Note

The following FCC information to the user is provided to comply with the requirements of 47 CFR, Part 18, Section 213.

Interference Potential

In our testing, SYNRAD has not discovered any significant electrical interference traceable to 32-1 lasers.

System Maintenance

Ensure that all exterior covers are properly fastened in position.

Measures to Correct Interference

If you suspect that your laser interferes with other equipment, take the following steps to minimize this interference:

- 1 Use shielded cables to and from the equipment that is experiencing interference problems.
- 2 Ensure that the laser is properly grounded to the same electrical potential as the equipment or system it is connected to.

FCC caution to the user

The Federal Communications Commission warns the user that changes or modifications of the unit not expressly approved by the party responsible for compliance could void the user's authority to operate the equipment.

Laser Safety

European Union (EU) requirements

RoHS compliance

SYNRAD® 32-1 lasers meet the requirements of the European Parliament and Council Directive 2015/863/EU on the Restriction of the Use of Certain Hazardous Substances in Electrical and Electronic Equipment that establishes maximum concentration values for certain hazardous substances in electrical and electronic equipment.

Laser safety standards

Under the Low Voltage Directive, 2006/95/EC, the European Norm (EN) document EN 60825-1:2007 was developed to provide laser safety guidance and includes clauses on Engineering Specifications, Labeling, Other Informational Requirements, Additional Requirements for Specific Laser Products, Classification, and Determination of the Accessible Emission Level. To develop a risk assessment plan/laser safety program for users, see IEC/TR 60825-14:2004 that includes clauses on Administrative Policies, Laser Radiation Hazards, Determining the MPE, Associated Hazards, Evaluating Risk, Control Measures, Maintenance of Safe Operation, Incident Reporting and Accident Investigation, and Medical Surveillance.

OEM models

32-1 OEM lasers are OEM products intended for incorporation as components in laser processing systems. As supplied by SYNRAD, these lasers do not meet the requirements of EN 60825-1:2014 without additional safeguards. European Union Directives state that “OEM laser products which are sold to other manufacturers for use as components of any system for subsequent sale are not subject to this Standard, since the final product will itself be subject to the Standard.” This means that Buyers of OEM laser components are solely responsible for the assurance that the laser processing system sold to an end-user complies with all laser safety requirements before the actual sale of the system. Note that when an OEM laser component is incorporated into another device or system, the entire machinery installation may be required to conform to EN 60825-1 :2014; EN 60204-1:2006, Safety of Machinery; the Machinery Directive, EN 2006/42/EC; and/or any other applicable Standards and in cases where the system is being imported into the U.S., it must also comply with CDRH regulations.

In cases where the Buyer is also the end-user of the OEM laser product, the Buyer/end-user must integrate the laser so that it complies with all applicable laser safety standards as set forth above. The following table shows the Class 4 safety features, summarizes 32-1 product features, indicating the type and description of features and whether those features are required by European Union regulations.

Electromagnetic interference standards

The European Union’s Electromagnetic Compatibility (EMC) Directive, 2004/108/EC, is the sole Directive developed to address electromagnetic interference (EMI) issues in electronic equipment. In particular, the Directive calls out European Norm (EN) documents that define the emission and immunity standards for specific product categories. For 32-1 lasers, EN 61000-6-4 defines radiated and conducted RF emission limits while EN 61000-6-2 defines immunity requirements for industrial environments.

Table 2-1 Class 4 safety features as required by CDRH and EN.

Feature	Location / Description	Required by:		Available on:
		CDRH	EN60825-1	OEM 32-1
Keyswitch	Rear panel control On/Off/Reset Keyswitch controls power to laser electronics. Key cannot be removed from switch in the "On" position.	Yes	Yes	No
Shutter function	Laser control Functions as a beam attenuator to disable RF driver/laser output when closed.	Yes	Yes	No
Shutter indicator	Rear panel indicator (Blue) Illuminates blue to indicate shutter is open.	No	No	No
Ready indicator ²	Rear panel indicator (Yellow) Indicates that laser has power applied and is capable of lasing.	Yes	Yes	No
Lase indicator	Rear panel indicator (Red) Indicates that is actively lasing. Lase LED illuminates when the duty cycle of the Command signal is long enough to produce laser output.	No	No	No
Power fail lockout ¹	circuit element Disables RF driver/laser output if input power is removed then later reapplied (AC power failure or remote interlock actuation) while Keyswitch is in "On" position.	Yes	Yes	No
Remote Interlock	Side panel connection Disables RF driver/laser output when a remote interlock switch on an equipment door or panel is opened.	Yes	Yes	Yes
Remote Interlock	Side panel indicator (Green/Red) Illuminates green when Remote Interlock circuitry is closed indicator Illuminates red when interlock circuitry is open.	No	No	No
Over temperature	circuit element Temperature shutdown occurs if temperature of the laser protection tube rises above safe operating limits.	No	No	Yes
Temp indicator	Side panel indicator (Green/Red) Illuminates green when laser temperature is within operating limits, changing to red when thermal limits are exceeded.	No	No	No
Warning labels	32-1 exterior Labels attached to various external housing locations to warn personnel of potential laser hazards.	Yes	Yes	Yes

1 On OEM versions, the Power indicator illuminates and the five (5) second delay begins when DC power is applied to the laser.

SYNRAD® 32-1 lasers have demonstrated performance characteristics that have met or exceeded the requirements of EMC Directive 2014/30/EU.

When integrating SYNRAD 32-1 OEM lasers, the Buyer and/or integrator of the end system is responsible for meeting all applicable Standards to obtain the CE mark. To aid this compliance process, SYNRAD testing program has demonstrated that 32-1 lasers comply with the relevant requirements of 2014/30/EU, the Electromagnetic Compatibility Directive, as summarized in the table below.

Table 2-2 European Union Directives.

Applicable Standards / Norms

2014/30/EU	Electromagnetic Compatibility Directive
2014/35/EU	Low Voltage Directive
2015/863/EU	RoHS Directive
EN 61010-1:2010	Safety Requirements for Electrical Equipment for Measurement, Control, and Laboratory Use - Part 1: General Requirements
EN 61000-6-4:2007	Radiated Emissions Group 1, Class A
EN 61000-6-4:2007	Conducted Emissions Group 1, Class A
EN 61000-6-2:2005	Electrostatic Discharge Immunity
EN 61000-6-2:2005	RF Electromagnetic Field Immunity
EN 61000-6-2:2005	Electrical Fast Transient/Burst Immunity
EN 61000-6-2:2005	Conducted RF Disturbances Immunity

After a laser or laser processing system has met the requirements of all applicable EU Directives, the product can bear the official compliance mark of the European Union as a Declaration of Conformity.

Declaration of Conformity

in accordance with ISO / IEC 17050-2:2004

We,

Manufacturer's Name: SYNRAD® A ©Novanta Company

Manufacturer's Address: 4600 Campus Place
Mukilteo, WA 98275 U.S.A.

Hereby declare under our sole responsibility that the following equipment:

Product Name: 32-1 Laser

Model Number: 32-1SAC (*OEM)

Conforms to the following Directive(s) and Standard(s):

Applicable Directive(s):	2014/30/EU	Electromagnetic Compatibility Directive
	2014/35/EU	Low Voltage Directive
	(EU) 2015/863	RoHS Directive

Applicable Standard(s):

EN 61010-1:2010	Safety Requirements for Electrical Equipment for Measurement, Control, and Laboratory Use - Part 1: General Requirements
EN 61000-6-4:2007	Radiated Emissions, Group 1, Class A
EN 61000-6-4:2007	Conducted Emissions, Group 1, Class A
EN 61000-6-2:2005	Electrostatic Discharge Immunity
EN 61000-6-2:2005	RF Electronic Fields Immunity
EN 61000-6-2:2005	Electrical Fast Transient/Burst Immunity
EN 61000-6-2:2005	Conducted RF Disturbances Immunity

*OEM lasers do not comply with EN 60825-1:2014, *Safety of Laser Products*. Buyers of OEM laser products are solely responsible for meeting applicable Directives and Standards for CE compliance and marking.

Corporate Officer:



Tim Freni, Quality Manager of SYNRAD

European Contact:

Novanta Distribution (USD) GmbH
Parkring 57-59
85748 Garching bei München, Germany

Dated: 7/22/19



MADE IN THE U.S.A.
900-20976-23 Rev C

Figure 2-5 32-1 Declaration Document.

Declaration of Conformity

in accordance with ISO / IEC 17050-2:2004

We,

Manufacturer's Name: SYNRAD® A ®Novanta Company

Manufacturer's Address: 4600 Campus Place
Mukilteo, WA 98275 U.S.A.

Hereby declare under our sole responsibility that the following equipment:

Product Name: 32-1 Laser for Panasonic

Model Number: 32-1SAC -SNX (*OEM)

Conforms to the following Directive(s) and Standard(s):

Applicable Directive(s): (EU) 2015/863 RoHS Directive

The laser listed above conforms to Directive 2011/65/EU of the European Parliament and of the council held on the 8th of June 2011 on the restriction of the use of certain hazardous substances in electrical and electronic equipment adopted by the European Union.

*OEM lasers do not comply with EN 60825-1:2014, *Safety of Laser Products*. Buyers of OEM laser products are solely responsible for meeting applicable Directives and Standards for CE compliance and marking.

Corporate Officer:

European Contact:

Novanta Distribution (USD) GmbH
Parking 57-59
85748 Garching bei München, Germany



Tim Freni, Quality Manager of SYNRAD

Dated: 7/22/19



MADE IN THE U.S.A.
900-20976-13 Rev C

Figure 2-5 (continued) 32-1 Declaration Document.

4

Technical reference summary

- Technical overview – briefly describes 32-1 technology, design RF power supply and basic optical setup.
- Control circuitry & cooling – introduces various aspects of the 32-1 control signals & cooling.
- DB-9 connections – describes input/output signals and specifications for the side mounted DB-9 connector.
- DC power – provides information about DC power.
- Integrating 32-1 safety features – describes how to integrate 32-1 safety features into your automated control system.
- 32-1 general specifications – provides specifications for the 32-1 laser.
- Model 32-1 package outline drawing – illustrates laser package and mounting dimensions for OEM 32-1.
- 32-1 packaging instructions – describes how to package 32-1 lasers for shipment.

Caution
Possible
Equipment
Damage

Small amounts of contaminants on the laser's output window (or on any optic in the beam path) can absorb enough energy to damage the optic. Inspect all beam delivery optics periodically for signs of contaminants and carefully clean as required.



In dirty environments, purge laser optics using filtered air or nitrogen to prevent vapor and debris from accumulating on optical surfaces.

Technical overview

- Introduction
- Plasma section
- Optical resonator
- Control circuitry
- Optical setup,
- Faults, cooling, and DuoLase®

Introduction

32-1 lasers incorporate the latest technology in sealed carbon dioxide devices, combining the best features of both waveguide and free space CO₂ laser technology. The all-metal laser tube construction features the ruggedness, stable optical support, and small size of waveguide lasers. Low cost is achieved by using simple extruded and welded aluminum structures packaged together with compact, state-of-the-art RF power supplies.

32-1 lasers emit a laser beam with a wavelength of 10.6 microns (μm). The laser beam diverges due to diffraction at a full angle of 8 mrad (milliradians), with the beam waist at the output aperture of the laser.

Power control of the laser beam is achieved by pulse width modulation (PWM) of the RF drive circuit. Modulation control can be used to gate the laser on and off at time intervals synchronized with automated processing equipment. It can also be used to control instantaneous power by adjusting the pulse width (PWM duty cycle) at a variable modulation frequency. Both methods can be used simultaneously.

Plasma section

The laser consists of an RF-excited plasma tube with an adjustable mirror on each end, mounted together with the RF drive assembly in a single aluminum chassis. The plasma tube is made of two-inch square cross-section extruded aluminum tubing with pre-machined ends welded on. RF drive power is applied between the two electrodes. The internal resonant circuit induces RF drive on the upper electrode that is 180 degrees out of phase with that of the lower electrode. Thus the voltage between the two RF electrodes is roughly twice that on either electrode. Waste heat is conducted away to the outer walls of the laser tube, where it is transferred to the chassis.

Optical resonator

The optical resonator consists of a curved total reflector and a flat Zinc Selenide (ZnSe) output coupler. The mirrors are held on with Viton (fluorocarbon) elastomeric o-rings for factory adjustment by means of three screws that are secured by adhesive after alignment. The ceramic bore in conjunction with the mirror curvatures selected favors a Gaussian (TEM₀₀) mode.

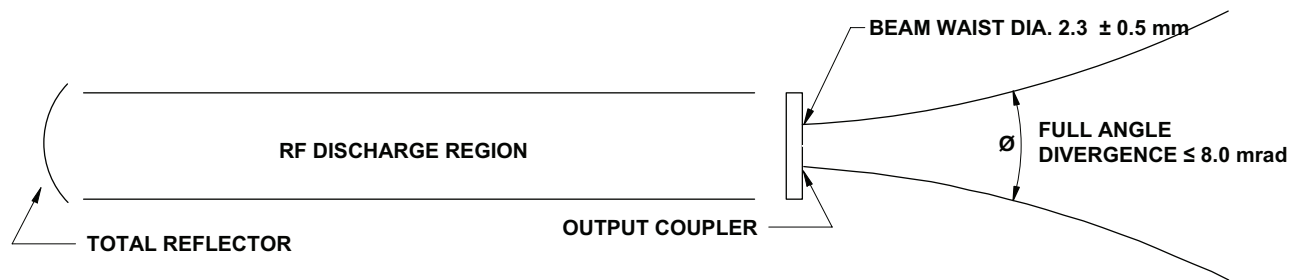

Figure 4-1 Beam characteristics.

Controlling Circuitry

Electrical description

Control of laser operation and power output levels is essentially performed using a single PCB. The Control PCB connects the modulated signal to the RF amplifier. It also provides electronics to monitor performance of RF control, output circuitry, input power, temperature, PWM accuracy, provides outputs to an externally accessible connector, and incorporates reverse polarity protection.

Model 32-1 lasers use a single RF electrode requiring a single modulated RF drive input from the Control PCB.

The modulated input PWM signal is generated externally to the laser and connected to the input connector. This signal is connected to an optoisolator, the output of which is applied to the PWM switch control circuit. The PWM switch control circuit gates the PWM switch off and on at the frequency and duty cycle controlled by the modulation source. When the PWM switch closes, a potential of +30 VDC is applied to the RF Driver. The PWM control circuit provides on/off gating of the PWM switch unless disabled by the five-second delay, or the fault shutdown circuits.

The five-second delay disables PWM output to the RF amplifier for a period of approximately five seconds after the Remote Keyswitch link is closed (power ON). Note that the supplied DB-9 jumper plug can be removed to allow the user to insert a remotely located relay or switch in series with the Remote Keyswitch.

Over temperature fault shutdown occurs when laser tube temperature reaches $60\text{ }^{\circ}\text{C} \pm 2\text{ }^{\circ}\text{C}$.

Control board operation begins when the supply voltage rises above +18 VDC and remains below +36 VDC. After start-up, the control board will shut the laser down if supply voltage falls below +15 VDC or rises above +36 VDC.

Technical Reference

If an electronics failure causes the control board to output PWM power to the RF Drivers in excess of 20% of the PWM input, a fault shutdown will occur.

To reset after any fault shutdown, correct the problem(s) then cycle the power on/off to the laser for 30-seconds. During any fault shutdown, the fault shutdown output (Pin 1 of the DB-9 connector) will latch to low state until a reset occurs.

Power-On Reset is defeated on all OEM versions. OEM customers must provide this required safety feature elsewhere as part of their equipment integration.

Cooling

32-1 electronics are mounted opposite the laser tube in the smaller section of the “H” bay and share the same cooling removal as the plasma tube. Typical efficiency of CO₂ laser plasma tubes operating in a TEM₀₀ mode is 10% to 12% (radiation out to RF power in). Factor in the conversion efficiency of AC input to RF output and the overall “wall plug” efficiency of these lasers drops to about 6% to 8%, resulting in a considerable amount of heat removal, even at 5 W output power levels; therefore, external cooling in the form of forced air is required.

Caution **Possible** **Equipment** **Damage**



Since 32-1 lasers are OEM products, they do not include cooling fans. Customers must provide some type of air cooling to prevent the laser from overheating. See the cooling requirements at the end of this chapter and cooling 101 located on our website.

Optical setup

After selecting a CO₂ laser for your processing system, the two most important elements to consider are: (1) delivery optics to transmit the beam to the work area; and (2) focusing optics to focus the beam onto the part or material to be processed. Each element is crucial in the development of a reliable laser-based material processing system and each element should be approached with same careful attention to detail.

Delivery optics

Divergence, or expansion, of the laser beam is important for materials processing since a larger beam entering the focusing optic produces a smaller focused spot. Because the laser beam diverges slowly, increasing 8 mm in diameter over every meter, 32-1 lasers should be mounted a distance of 1.0–1.5 m (40–60 in) away from the work area. Right angle turning mirrors are often used in conjunction with the laser mounting position to obtain this distance. Figure below shows how right angle turning mirrors in a “flying optics” setup create this longer beam path.

Expander/collimators are optical devices that reduce beam divergence while at the same time increasing beam diameter by a selectable magnification factor. Adding an expander/collimator to the “flying optics” setup shown below would substantially reduce beam divergence and any variance in beam diameter caused by the changing optical path length. In fixed-length delivery systems where the laser is positioned only one meter away from the focusing optic and a small spot size is required, an expander/collimator is again the best solution to provide the required beam expansion before reaching the focusing optic.

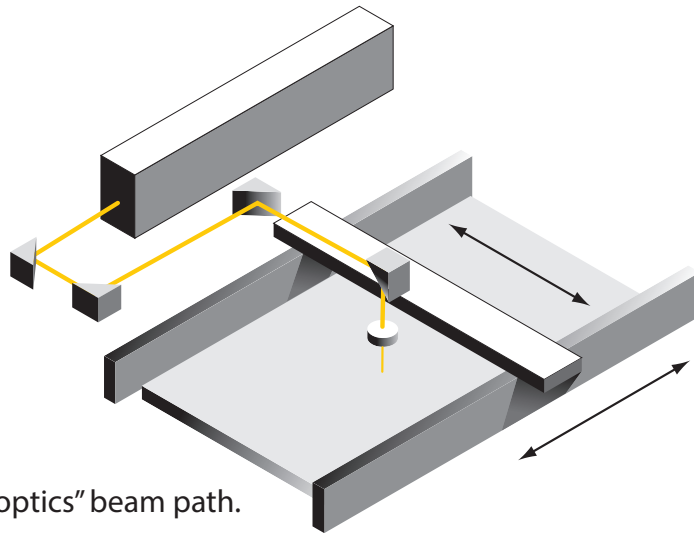

Figure 4-2 “Flying optics” beam path.

Focusing optics

When selecting a focusing optic, the primary consideration should be material thickness and any vertical tolerances that occur during final part positioning rather than making a selection based only on minimum spot size. The chosen focal length should create the smallest possible focused spot while providing the depth of field required for the material to be processed. Optics are fragile and must be handled carefully, preferably by the mounting ring only. Be careful to select optics that are thick enough to withstand the maximum assist gas pressure available for the process. This is especially important in metal cutting applications using high-pressure assist gases.

Technical Reference

Cleanliness is another important issue affecting performance and becomes increasingly important as laser power increases. Dirty or scratched lenses will under perform, exhibit a vastly shortened lifetime, and may fail catastrophically.

When the application requires air (instead of nitrogen) as an assist gas, use only breathing quality air available in cylinders from a welding supply company. Compressed shop air contains minute particles of oil and other contaminants that will damage optical surfaces. If compressed shop air is the only choice available, it must be filtered and dried to ISO 8573-1:2010 Class 1, 2, 1 specifications shown in the table below.

Table 4-2 Assist gas purity specifications.

Assist Gas	Typical Purpose		Specification
Air	Cutting/Drilling	Breathing Grade	$\geq 99.9996\%$ purity; filtered to ISO Class 1 particulate level
Air	Cutting/Drilling	Compressed	Instrument-grade air filtered and dried to ISO 8573-1:2010 Class 1, 2, 1 (≤ 10 1.0–5.0 μm particles/ m^3 ; ≤ -40 °F dew point; ≤ 0.01 mg/ m^3 oil vapor)
Argon	Welding	High Purity Grade	$\geq 99.998\%$ purity; filtered to ISO Class 1 particulate level
Helium	Welding	High Purity Grade	$\geq 99.997\%$ purity; filtered to ISO Class 1 particulate level
Nitrogen	Cutting/Drilling	High Purity Grade	$\geq 99.9500\%$ purity; filtered to ISO Class 1 particulate level
Oxygen	Cutting/Drilling	Ultra Pure Grade	$\geq 99.9998\%$ purity; filtered to ISO Class 1 particulate level

Technical Reference

User I/O Connections

Control signals

- Control signals
- Operating modes

Much of the information provided in this section describes the use of a SYNRAD® UC-2000 Universal Laser Controller to provide tickle and PWM signals to the laser. If you are using an alternate method of laser control, thoroughly review this section for an understanding of the signal requirements necessary to control SYNRAD 32-1 lasers. The table below lists input voltage and current specifications for 32-1 (PWM) inputs. Tables above and below provide specific tickle pulse and PWM signal parameters.

Table 4-3 Input signal specifications.

Parameter	Specification
Logic Low (Off State)	0.0 V to +0.5 VDC; 0.0 VDC nominal
Logic High (On State)	+3.5 V to +10.0 VDC; +5.0 VDC nominal
Maximum Current Load	6 mA (32-1 / 32-1); 12 mA (32-1)

Tickle pulse

32-1 lasers require a 1 μ s tickle pulse delivered at a nominal 5 kHz clock frequency from the Controller. Tickle pulses pre-ionize the laser gas to just below the lasing threshold so that any further increase in pulse width adds enough energy to the plasma to cause laser emission. This tickle signal causes the laser to respond predictably and almost instantaneously to PWM signals, even when there is considerable delay (laser off time) between applied PWM signals. The lase threshold is preset for 3 μ s \pm 0.5 μ s based on a PWM and tickle frequency input of 5 kHz. See the following table for tickle specifications.

Caution **Possible** **Equipment** **Damage**



Applying PWM pulses directly to the laser without first sending tickle pulses, for at least two seconds, will cause unpredictable laser emission, degrade optical rise time, and may lead to RF Driver failure.

Technical Reference

User I/O Connections

Table 4-4 Tickle pulse specifications.

Parameter	Specification
Tickle Frequency	5 kHz
Pulse Length	1.0 $\mu\text{s} \pm 0.2 \mu\text{s}$
Pulse Rise/Fall Time	$\leq 100 \text{ ns}$ between +0.5 V to +3.5 VDC

The UC-2000 does not produce tickle pulses continuously, but generates them only when the PWM signal is low. Tickle pulses are sent one tickle period, 200 μs , after the falling edge of a PWM signal pulse. Figure below illustrates tickle pulse parameters.

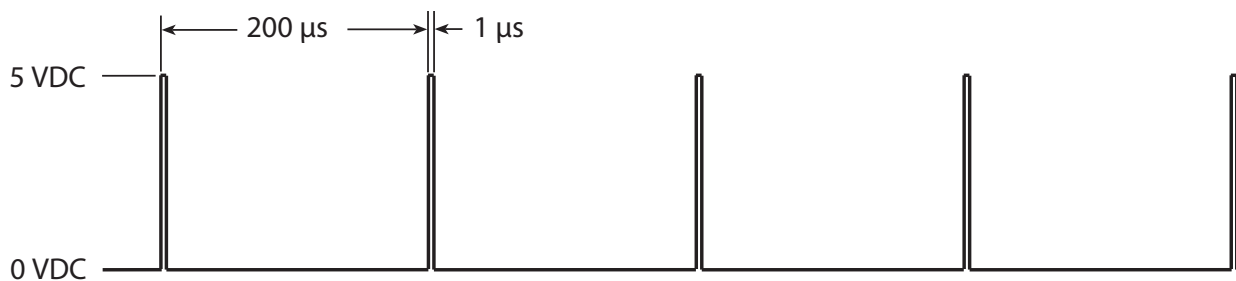

Figure 4-3 Tickle pulse waveform.

32-1 lasers are designed to operate at a tickle frequency of 5 kHz, which allows the laser to meet published specifications. Tickle frequencies lower than 4.5 kHz may compromise laser performance, particularly optical rise times, and stress the RF electronics thereby reducing long term reliability while tickle frequencies greater than 5 kHz may cause unintended lasing. Special care must be taken to maintain plasma ionization without lasing at tickle frequencies greater than 5 kHz. When sending 1 μs tickle pulses at 5 kHz, PWM signals can be sent at an independent, higher frequency but must go to near zero (< 1%) duty cycle to ensure laser turn-off.

Pulse width modulation (PWM)

Pulse Width Modulation, or PWM, controls laser power by varying the duty cycle of the laser's RF amplifiers, which in turn control the time-averaged RF power applied to the laser. Because laser output follows PWM input with a rise and fall time constant of $\sim 100 \mu\text{s}$, the laser cannot precisely follow PWM signal frequencies over 5 kHz with duty cycles greater than 50%. Typically, the depth of modulation for a 50% duty cycle is 90 to 100% at 2 kHz and 60 to 80% at 5 kHz. The following figure shows 32-1 optical waveforms at two different modulation frequencies.

Technical Reference

User I/O Connections

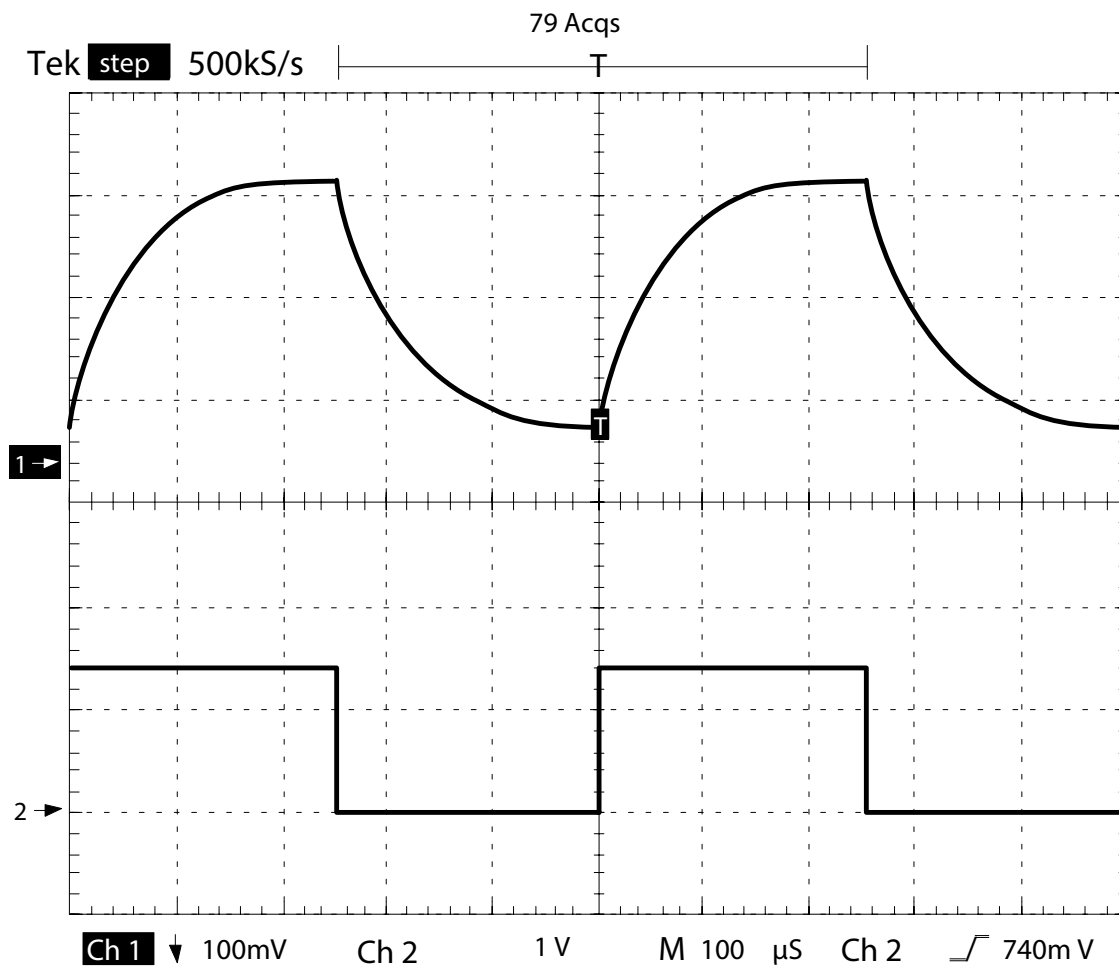

2 kHz Modulation

Figure 4-4 32-1-2 kHz waveform. The upper waveform is laser output, the lower waveform is PWM input.

Technical Reference

User I/O Connections

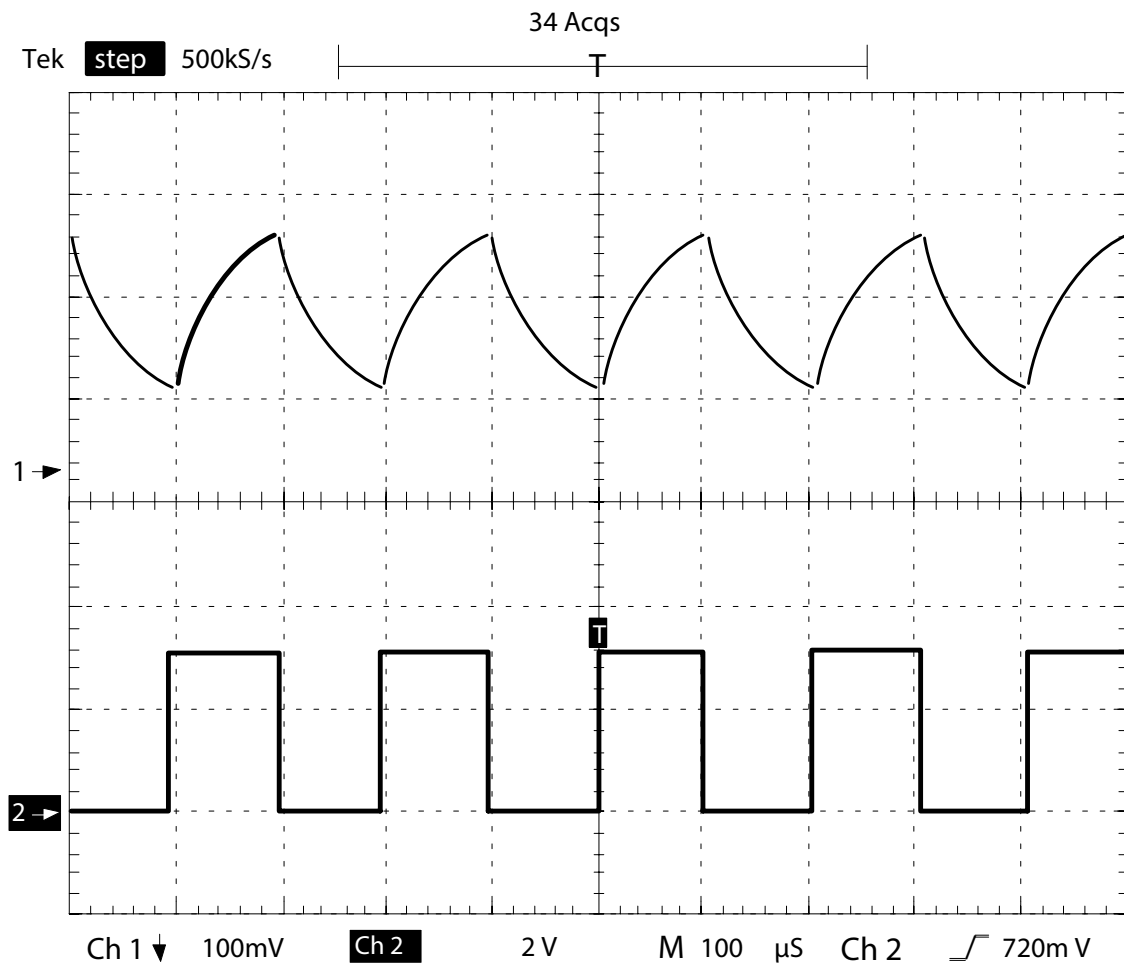

5 kHz Modulation

Figure 4-5 32-1-5 kHz waveform. The upper waveform is laser output, the lower waveform is PWM input.

Technical Reference

User I/O Connections

32-1 lasers are designed to operate at PWM signal base frequencies up to 20 kHz; however, the choice of PWM frequency depends on the user's specific application. In the majority of laser applications, the UC-2000's default PWM signal frequency of 5 kHz has proven to work well. When considering PWM frequencies at 5 kHz or below, please review Marking/engraving operation later in this chapter.

For high-speed motion applications that cannot tolerate any ripple in the optical beam response but still need adjustable power levels, we recommend the use of higher PWM frequencies, up to 20 kHz maximum. At 20 kHz, the laser's optical beam response no longer follows the PWM input and is very nearly a DC value with just a small amount of ripple present.

Warning
Serious
personal
injury



Always use shielded cable when connecting your PWM signal source to the laser's PWM connections.

In electrically-noisy environments, long lengths of unshielded wire act like an antenna and may generate enough voltage to trigger uncommanded lasing.

PWM signal

The modulated PWM signal applied to 32-1 lasers has three parameters: signal amplitude, base frequency, and PWM duty cycle. By changing these parameters, you can command the beam to perform a variety of marking, cutting, welding, or drilling operations.

The first PWM signal parameter, signal amplitude, is either logic low—corresponding to laser beam off, or logic high—corresponding to beam on. The laser off voltage, typically 0 V, can range from 0.0 V to +0.5 VDC while the laser on voltage, typically 5 V, can range from +3.5 V to 10.0 VDC.

Base frequency, the second parameter, is the rate at which the amplitude is switched between its low and high logic states. The standard base frequency is 5 kHz, which has a period of 200 μ s. Maximum PWM frequency is 20 kHz.

The third PWM signal parameter, PWM duty cycle, is the percentage of the period that the PWM signal is high. If the PWM signal's amplitude (at 5 kHz) is high for 100 μ s and low for 100 μ s, it has a 50% duty cycle; if the amplitude is high for 190 μ s and low for 10 μ s, it has a 95% duty cycle. The following figure illustrates PWM signal parameters while the following table lists PWM signal specifications.

Technical Reference

User I/O Connections

Table 4-5 PWM signal specifications.

Laser State	Minimum	Nominal	Maximum
Laser Off Voltage	0.0 VDC	0.0 VDC	+0.5 VDC
Laser On Voltage	+3.5 V	+5.0 VDC	+10.0 VDC
Current (@ 5 VDC)	— —	— —	6 mA (32-1)
Frequency Range	0 Hz (DC)	5 kHz	20 kHz
Duty Cycle	0%	— —	100%

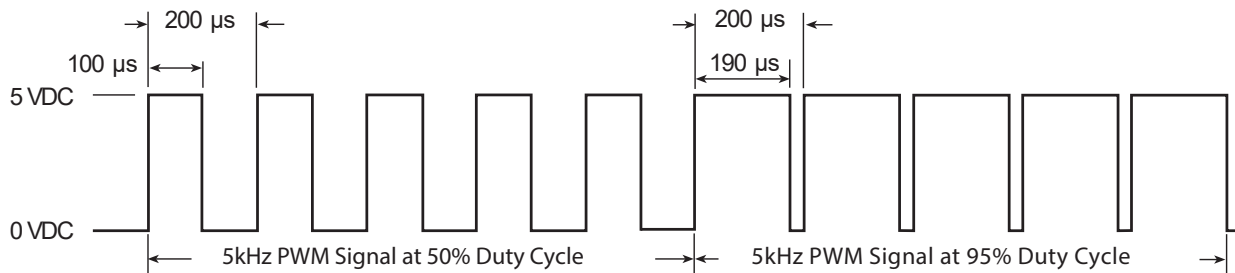

Figure 4-6 PWM signal waveform.

Operating modes

External control

In addition to controlling your 32-1 laser using a UC-2000 Controller, controlling the laser externally, without a UC-2000, is also possible. The two primary elements of laser control are gating, the ability to turn the laser on and off at the appropriate times, and power, the ability to control the laser's output energy. Both gating and power can be handled by a device such as a personal computer, Programmable Logic Controller (PLC), or a function generator capable of sending PWM pulses at the proper time (gating) and with the proper duty cycle (power).

Analog voltage or analog current control

Although 32-1 lasers cannot be controlled directly by analog voltage or current signals, this type of control is possible when using the UC-2000 Controller. The Controller is connected normally to the laser and analog voltage or current signals sent to the UC-2000's ANV/C connector then control both gating and power.

Technical Reference

User I/O Connections

To generate the correct analog voltage from a computer or PLC, a Digital-to-Analog (D/A or DAC) card capable of generating 0 V (laser off) to 10 V (maximum laser power) must be installed. To generate the proper analog current, install a D/A card that can generate 4 mA (laser off) to 20 mA (maximum power). Software able to control your analog output card is required for both configurations.

UC-2000 Universal Laser Controller

SYNRAD® recommends using a UC-2000 Universal Laser Controller to generate tickle pulses and Pulse Width Modulated (PWM) signals to control the laser's output power. The UC-2000 requires 15–50 VDC @ 35 mA, supplied from either its wall plug transformer or from the Auxiliary Power connector on the side of 32-1 lasers. Refer to the UC-2000 Laser Controller Operator's Manual for information about UC-2000 operation.

To connect a UC-2000 Controller (available separately from SYNRAD), perform the following steps:

- 1 Remove DC power from the laser. Fabricate a suitable DB-9 plug so Pin 3, PWM Positive, connects to the center pin of the BNC and Pin 4, PWM Negative, connects to the shield.
- 2 If your system does not provide an enable input to the DB-9 plug, then jumper Pin 6, remote keyswitch to Pin 7, remote keyswitch Out.
- 3 Connect the DB-9 plug to the DB-9 I/O connector on the rear of the laser.
- 4 Connect the miniature DC power plug on the UC-2000's Power/Control cable to the miniature connector on the wall plug transformer cable.
- 5 Connect the mini-DIN connector on the other end of the UC-2000's Power/Control cable to the Laser connector on the UC-2000's rear panel.

Continuous wave (CW) operation

In some applications, such as high speed marking or cutting, the time constant of the laser and the PWM modulation causes a series of dots that may be visible on the marking surface instead of a "clean" line. Operating the laser in CW mode will prevent this behavior from occurring. To operate the laser in CW mode, a constant +5 VDC signal is applied to the PWM input(s) of the laser. This constant voltage source forces the internal switching electronics to remain on, providing continuous and uninterrupted laser output power.

For pure CW operation, a steady +5 V signal can be applied through this connector (a tickle signal must be applied during laser-off periods). This input is optically-isolated from the chassis and power supply ground circuit, but must not be subjected to common mode voltages greater than ± 50 VDC from chassis ground. The 32-1 laser has one PWM input that should always be driven identically from the signal source by using a "Y" cable.

Technical Reference

User I/O Connections

Gated operation

In many marking and cutting applications, the laser is required to pulse, or gate, on and off in synchronization with an external control signal (typically from a computer or function generator operating in the range from DC to 1 kHz). To pulse or gate the laser, connect a signal providing +5.0 VDC pulses to the Gate connector on the rear panel of the UC-2000.

Users who intend to use a gating signal should set the UC-2000's gate input logic to internal Pull-Down (normally off) mode. This prevents the beam from being enabled unless a high level (+3.5 V to +5.0 VDC) signal is applied to the Gate input connector. In the pull-down (normally off) mode an asserted logic low state, short circuit to ground, or an open or disconnected Gate input locks the beam off.

Many CO₂ lasers operating in applications requiring short gating pulses at repetition rates below 500 Hz will exhibit some leading edge overshoot regardless of the PWM frequency. This occurs because a cooler lasing medium (the CO₂ gas) is more efficient than a hotter one. This overshoot is more pronounced at lower gating frequencies since the gas has a longer time to cool down between PWM signal pulses.

Warning
Serious
personal
injury



The UC-2000's default gate logic is factory set to internal Pull-Up (normally on) mode so that an open (disconnected) Gate input causes the laser to turn on. This functionality allows the user to easily test and verify laser operation prior to integration.

In an integrated system, you should configure the UC-2000's gate input logic to internal Pull-Down (normally off) mode. This prevents the beam from being enabled unless a high level (+3.5 V to +5.0 VDC) signal is applied to the Gate input connector. In the Pull-Down (normally off) mode, an asserted logic low signal, short circuit to ground, or an open or disconnected Gate input locks the beam off.

Note: When operating in CW mode, laser power output cannot be adjusted. If you require an adjustable output power level, refer to the Pulse width modulation (PWM) section for information regarding high frequency operation.

Technical Reference

User I/O Connections

Caution
Possible
Equipment
Damage



Do not ground the Remote Keyswitch input to an external circuit—this will damage laser circuitry. Any external circuit(s) connected to these terminals must be floating with respect to ground. We recommend using “dry circuit” (zero voltage) switches or relay circuitry.

DB-9 connections

32-1 lasers are equipped with a female DB-9 connector mounted to the sidewall of the laser. The DB-9 connector provides the user with a convenient method for monitoring fault conditions (over temperature, control/RF circuitry failure, etc.) and adds, remote keyswitch (relay or switch), and remote LED indicator capability. These signals allow you to connect remote keyswitch, LASE, and ready (PWR) indicators to a remote operator’s station or connect a remote interlock safety switch to interlock equipment doors or panels.

Note: You can control 32-1 lasers from an alternate user-supplied PWM signal source. See Controlling laser power in the Technical Reference chapter for control signal descriptions.

Technical Reference

User I/O Connections

User I/O connections

- User I/O connection summary
- Input/output signals
- Sample I/O circuits

The PWM signal and all input/output (I/O) control signals are connected to the User I/O port. Please refer to the figure below for the 9 pin female D-type sub-miniature connector on the side of the laser. The figure below illustrates the pin arrangement of the User I/O connector.

DB-9 connections

The figure below shows the physical layout and pin identification of the 32-1 DB-9 Connector. Refer to the following tables in the next two pages describing input/output signal specifications.

Figure 4-7 Physical layout of 32-1 DB-9 Connector.

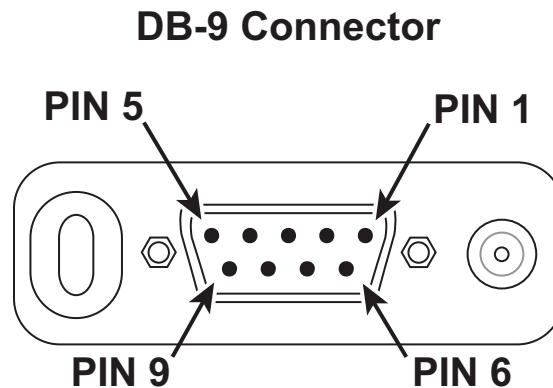

I/O Fault Diagrams

Table 4-6 DB-9 pin assignments.

Pin#	Function & Description
------	------------------------

1	Fault Shutdown Output Indicates failure of internal circuitry or existence of over temperature ($> 60\text{ }^{\circ}\text{C} \pm 2\text{ }^{\circ}\text{C}$), over voltage, or under voltage fault. This active low signal (referenced to Pin 2 or Pin 4) transitions from +15 V (normal operation) to 0 VDC when a fault occurs. Use this output signal to disable external processes during a fault ¹ . See the two following table(s) for output signal specifications.
2	Signal Ground Signal ground/chassis ground for Pins 1, 8, and 9.
3	PWM (+)
4	PWM (-)
5	No Connection
6	Remote Keyswitch Input Connect a remote relay or switch in series with the laser Keyswitch (If customer installed) to control laser On / Off / Reset functions. Connect Pin 6 to Pin 7 to run; open this connection to halt lasing or reset faults. As shipped, Pins 6 and 7 are connected by the factory-installed jumper plug to enable the Remote Keyswitch function ^{2,3} . See the two following table(s) for input signal specifications.
7	Remote Keyswitch Output Connect Pin 7 to Pin 6 to enable the Remote Keyswitch function (see Pin 6 description above). Pin 7 is at DC line potential (+30 VDC) only when the Keyswitch is set to ON. As shipped, Pins 6 and 7 are connected by the factory-installed jumper plug ^{3,4} . See the two following table(s) for output signal specifications.
8	Remote Lase LED Output Connect an LED or LED-optoisolator between Pin 8 and Signal Ground for a remote LASE indication ^{5,6} . See the two following table(s) for output signal specifications.
9	Remote Ready LED Output Connect an LED or LED-optoisolator between Pin 9 and Signal Ground for a remote Ready (PWR) indication ⁵ . See the two following table(s) for output signal specifications.

¹ Pin 1 is an active low output. Specifications: OFF: +15 VDC, 5 mA into 3 kOhm. ON: < 1 VDC, sinking 100 mA.

² "Dry-circuit" (zero voltage) external switches are required since current into debounced remote keyswitch pins is negligible.

³ The remote keyswitch output pin is not current-limited or fused.

⁴ Pins 8 and 9 can be directly connected to the anodes of LEDs or LED-input optoisolators without external current limiting devices. Connect LED cathodes to Pin 2. Current is limited internally to 20 mA at 3.3 V maximum.

⁵ The output of Pin 8, the Remote Lase LED Output, is a Pulse Width Modulated (PWM) signal based on the PWM input signal. It is not a steady state (on/off) output.

Technical Reference

User I/O Connections

Table 4-7 DB-9 Connector input signal specifications.

Pin #	Input Signal Name	Input Specifications
3	PWM (+)	Apply a 5VDC Pulse Width Modulated (PWM) signal to the laser's control input connector.
4	PWM (-)	
6	Remote Keyswitch Input	Circuit" (zero-voltage) external switches to prevent internal circuit damage.

Table 4-8 DB-9 Connector output signal specifications.

Pin #	Output Signal Name	Output Specifications
1	Fault Shutdown Output	Active Low output signal: Off: + 15 VDC, 5 mA into 3 kOhm;
7	Remote Keyswitch Output	50 mA maximum @ 30 VDC. Output active (+30 VDC) when Keyswitch ON or bypassed (OEM models).
8	Remote Lase LED Output	Current-limited to 11 mA @ 2.4 VDC maximum. Voltage output is pulse width modulated at input PWM signal frequency, <u>not</u> a steady state on/off signal.
9	Remote Ready LED Output	Current-limited to 11 mA @ 2.4 VDC maximum.
2	Signal Ground	Signal ground for pins 1, 8, and 9.

Technical Reference

User I/O Connections

Sample DB-9 Connector I/O circuits

Sample input circuits

The figure below illustrates a method of connecting a relay contact or limit switch to act as a remote keyswitch. Remember that Remote Keyswitch and Remote Interlock inputs are “dry circuit” or zero-voltage inputs.

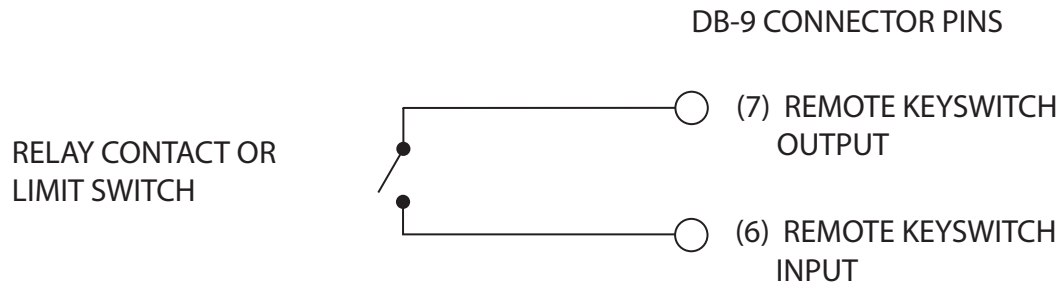

Figure 4-8 Remote Keyswitch circuit.

Technical Reference

User I/O Connections

Sample output circuits

Figures below illustrate how to connect the laser's Remote Ready LED Output to a Programmable Logic Controller (PLC) DC input module using current sourcing, current sinking, and resistive pull-up methods.

Note: You can use these same circuits to monitor the laser's Remote Lase LED Output (DB-9, Pin 8); however, the Remote Lase LED Output is not a steady state (on/off) output. It is a Pulse Width Modulated (PWM) signal based on the PWM input signal to the laser.

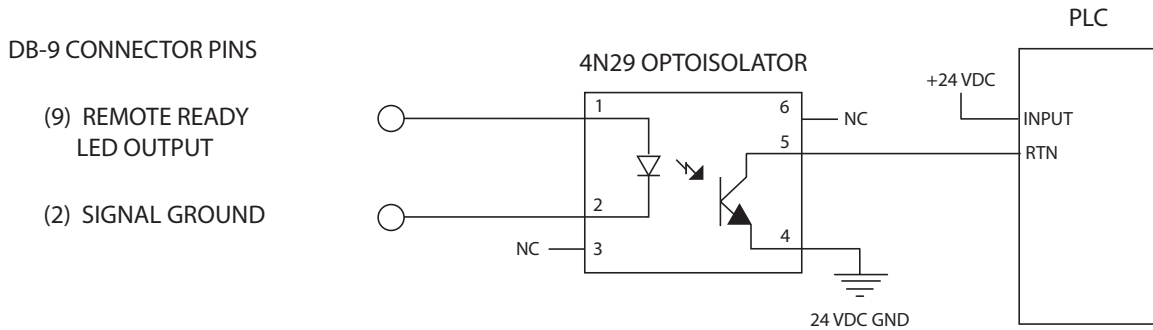

Figure 4-9 Remote Ready output to PLC input (PLC sourcing).

The following figure illustrates how to connect the Fault Shutdown Output signal to a PLC. The Fault Shutdown Output function signals a laser shutdown due to an under/over voltage condition, an over temperature condition, or failure of internal circuitry.

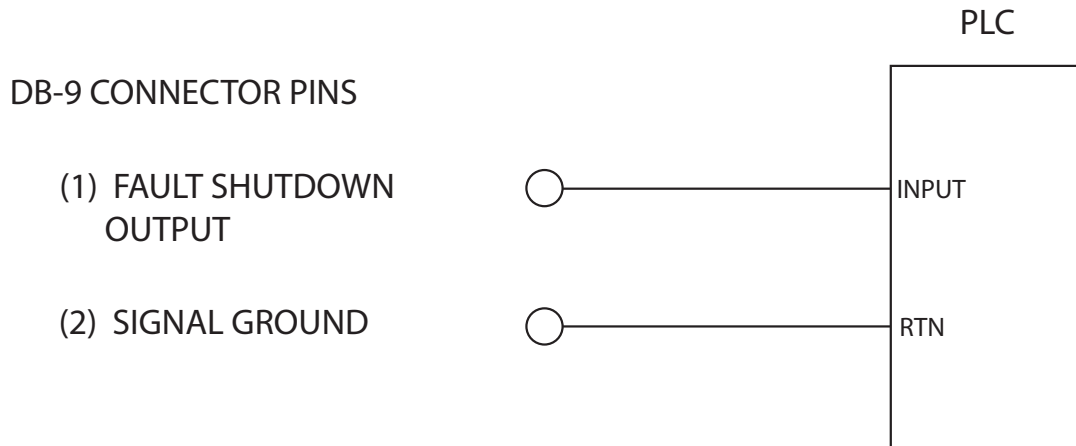

Figure 4-10 Fault Shutdown Output to PLC input.

Technical Reference

Integrating 32-1 safety features

The Integrating 32-1 safety features section includes subsections:

■ Remote Keyswitch functions

The 32-1 DB-9 Connector allows system integrators or end-users to integrate 32-1 laser safety features into their control system. In particular, the 32-1 Remote Keyswitch function serves to disable DC power to the laser's RF driver. Without power, the RF driver cannot supply PWM or tickle signals to the resonator, causing the CO₂ gas to remain in a zero-energy state.

Important Note:



Pin 9, the Remote Ready LED Output, is a current- and voltage-limited output meant only for direct connection to an LED or LED-input optoisolator.

OEM lasers

On OEM lasers, 5-seconds after power-up DC power is applied to the RF driver. To reset a fault condition, remove DC power for 30 seconds and then reapply power to the laser or toggle (open, then close) the Remote Keyswitch signal via pins 6 and 7 on the DB-9 Connector. To use this "remote reset" functionality, open and then close a "dry-circuit" (zero voltage) switch or relay contact between Pin 6, Remote Keyswitch Input, and Pin 7, Remote Keyswitch Output. Reconnecting Pin 6 to Pin 7 applies power to the RF driver and begins a five-second delay after which lasing is enabled.

Your control system can monitor the laser's power-on status through the DB-9 Connector by connecting your system's input between Pin 9, Remote Ready LED Output, and Pin 2, Signal Ground. The Remote Ready LED Output goes active when the laser is enabled, indicating that lasing is possible after the five-second delay. The output is inactive when lasing is disabled. Refer back to the, DB-9 pin assignment tables for specific details.

Note: 32-1 lasers may be hard-mounted to equipment by removing several of the bottom panel screws and replacing these with longer screws to secure the laser to optical assemblies. This mounting method is only recommended as long as the screws do not support the weight of the laser. For a sturdier attachment, the laser may be clamped to optical assemblies by applying clamping forces between top and bottom cover screws. Do not apply clamping forces on the longitudinal centerline.

Technical Reference

General Specifications

Table 4-9 Model 32-1 general specifications.

Parameter	32-1 (10.6 μm)
Output Specifications	
Wavelength (microns μm)	10.57μm-10.63 μm [†]
Power Output ^{1,2}	5 W
Power Stability ³ (Cold Start)	±15%
Mode Quality ³	$M^2 \leq 1.2$
Beam Diameter, mm (at 1/e ²) ⁴	2.3 mm ± 0.5 mm
Beam Divergence, full angle	≤ 8.0 mrad
Ellipticity	< 1.2
Polarization	Random
Rise Time (Measured at 1 kHz, 50% duty cycle)	< 150 μs
Input Specifications	
Power Supply	
Voltage	30 VDC ± 2.0 VDC
Maximum current	4.0 A
Input Signals	
Frequency	DC- 25kHz
Cooling Specifications	
Maximum Heat Load	150 Watts
Maximum Tube Temperature	60 °C
Minimum Flow Rate	150 CFM per fan two (2) required
Environmental Specifications	
Operating Ambient Temperature Range	5 °C - 40 °C
Humidity	≤ 80% RH, non-condensing
Physical Specifications	
Length	11.2 in (284 mm)
Width	2.8 in (71 mm)
Height	4.2 in (106 mm)
Weight	7.0 lbs (3.18 kg)

Specifications subject to change without notice.

† Typical. Actual wavelength range may vary from 10.2–10.8 μm.

1 This power level is guaranteed for 12 months regardless of operating hours.

2 Minimum 30 VDC input voltage to obtain guaranteed output power.

3 From cold start (guaranteed) at 95% duty cycle.

4 Measured at laser output.

5 32-1 lasers are designed to operate at a tickle frequency of 5 kHz, which allows the laser to meet published specifications. Tickle frequencies lower than 4.5 kHz may compromise laser performance, particularly optical rise times, and stress the RF electronics thereby reducing long term reliability while tickle frequencies greater than 5 kHz may cause laser emission.

6 FCC and CE tested at 5 kHz.

Technical Reference

Outline and Mounting Diagrams

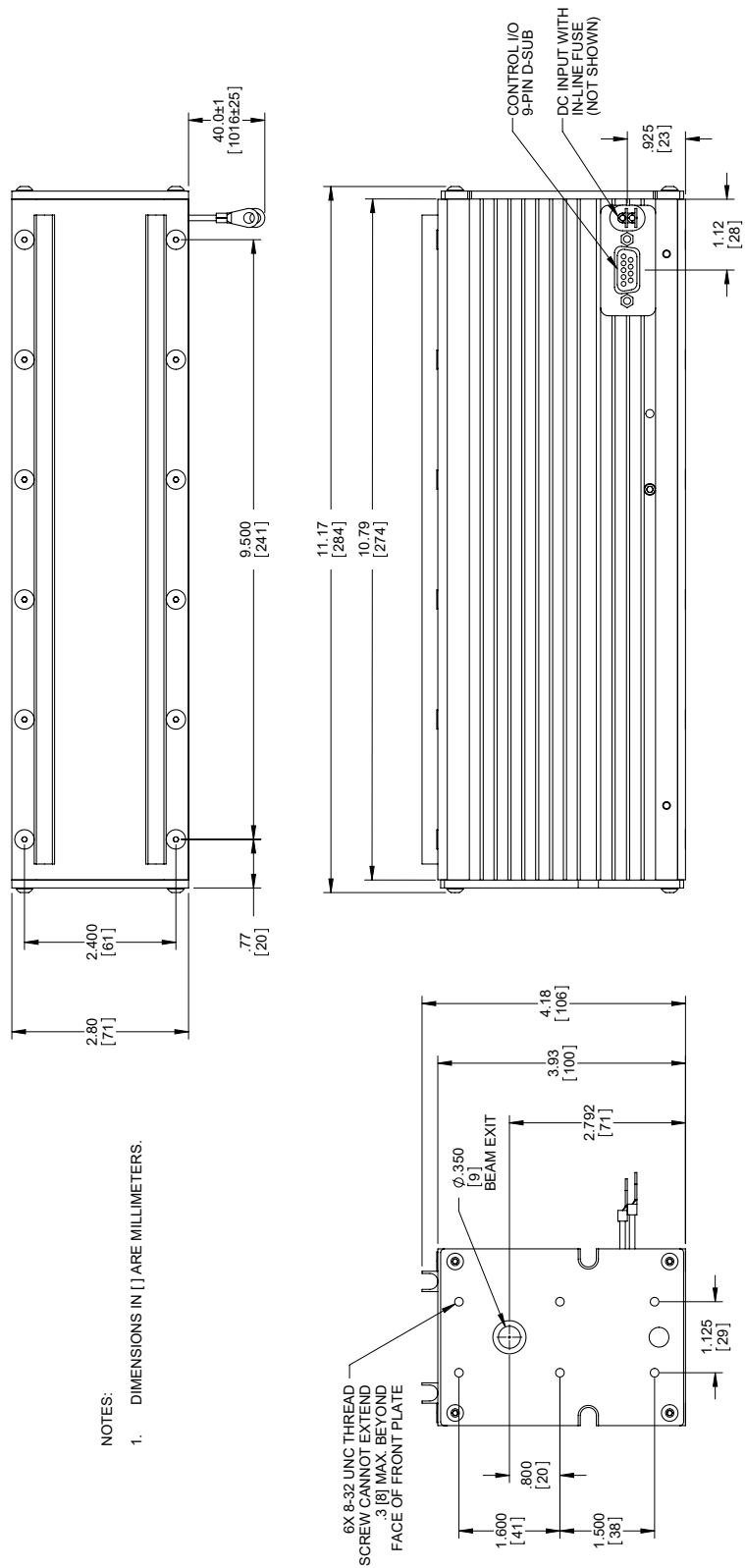

Figure 4-11 Model 32-1 package outline and mounting dimensions, 1 of 1.

Maintenance/ Troubleshooting

Maintenance

5

Maintenance and Troubleshooting

Introduction

- Maintenance – describes typical 32-1 series maintenance procedures.
- Troubleshooting – explains how to troubleshoot common 32-1 series problems.

Important Note:



This section of the Operation Manual explains how to conduct regular maintenance and/or basic troubleshooting to 32-1 lasers. If you cannot attend to the unit using the information described in this manual, contact SYNRAD®, (+.425.349.3500) or an authorized SYNRAD Distributor.

Warning Serious personal injury



This Class 4 laser product that emits invisible infrared laser radiation in the 10.6 μm CO₂ wavelength band.

Because direct or diffuse laser radiation can inflict severe corneal injuries, always wear eye protection when in the same area as an exposed laser beam.

Do not allow the laser beam to contact a person.

This product emits an invisible laser beam that is capable of seriously burning human tissue.

Always be aware of the beam's path and always use a beam block while testing.

The use of aerosol dusters containing difluoroethane causes "blooming", a condition that **significantly** expands and scatters the laser beam. This beam expansion can affect mode quality and/or cause laser energy to extend beyond the confines of optical elements in the system, possibly damaging acrylic safety shielding. **Do not use air dusters containing difluoroethane** in any area adjacent to CO₂ laser systems because difluoroethane persists for long time periods over wide areas.

A risk of exposure to toxic elements, like zinc selenide, may result when certain optical or beam delivery components are damaged. In the event of damage to laser, marking head, or beam delivery optics, contact SYNRAD, or the optics manufacturer for handling instructions.

Maintenance/ Troubleshooting

Maintenance

Maintenance

- Disabling the 32-1 laser
- Daily inspections
- Storage/shipping
- Cleaning optical components

Disabling the 32-1 laser

Before performing any maintenance on your laser, be sure to completely disable the laser by disconnecting the DC Power Cables from the DC power supply.

Daily inspections

Perform the following steps daily to keep your laser in optimum operating condition. Except for the procedures described below, no other service is required or should be attempted.

Warning Serious personal injury

A risk of exposure to toxic elements, like zinc selenide, may result when certain optical or beam delivery components are damaged. In the event of damage to laser, marking head, or beam delivery optics, contact SYNRAD or the optics manufacturer for handling instructions.



Ensure that DC power to the laser is turned off and locked out before inspecting optical components in the beam path.



Invisible CO₂ laser radiation is emitted through the aperture. Corneal damage or blindness may result from exposure to laser radiation.

- 1 Inspect beam delivery components for signs of dust or debris and clean as required. When cleaning the optical surfaces of beam delivery components, carefully follow the manufacturer's instructions.
- 2 Visually inspect the exterior housing of the laser to ensure that all warning labels are present. Refer to the Laser Safety chapter for label types and locations.

Maintenance/ Troubleshooting

Maintenance

Storage/shipping

Refer to Packaging instructions in the Technical Reference chapter and/or appropriate quick start guide for detailed instructions on properly packaging the laser for shipment.

If you no longer have the original shipping box and inserts, contact SYNRAD® Customer Service about purchasing replacement packaging.

Important Note:



Failure to properly package the laser using SYNRAD-supplied shipping boxes and foam/cardboard inserts as shown in the Packaging instructions may void the warranty. Customers may incur additional repair charges for shipping damage caused by improper packaging.

Caution

Possible
Equipment
Damage



Even small amounts of contamination on optics in the beam path can absorb enough energy to damage the optic.

Inspect beam delivery optics periodically for signs of contaminants and carefully clean as required.

Debris or contaminants on the laser's output coupler or external beam delivery components may affect laser processing and lead to damage or failure of the optics and/or the laser. Carefully follow the steps below to inspect and clean the optical components in the beam path. Before beginning the cleaning process, read this entire section thoroughly to ensure that all cleaning materials are available and that each step is completely understood.

Important Note:



Exercise great care when handling infrared optics; they are much more fragile than common glass materials. Optical surfaces and coatings are easily damaged by rough handling and improper cleaning methods.

Maintenance/ Troubleshooting

Maintenance

Cleaning guidelines

- Before using any cleaning agents, read Safety Data Sheets (SDS) and observe all necessary safety precautions.
- Wear latex gloves or finger cots (powder-free) to prevent contamination of optical surfaces by dirt and skin oils.
- Never handle optics with tools; always use gloved hands or fingers.
- Hold optics by the outer edge; never touch the coated surface.
- Always place optics on a tissue or suitable equivalent material for protection; never place optics on hard or rough surfaces.
- It may be necessary to use a cotton ball or fluffed cotton swab instead of a lens wipe to uniformly clean the entire surface of small-diameter mounted optics.

Required cleaning materials

The table below lists the type and grade of materials required to properly clean optical surfaces.

Table 5-1 Required cleaning materials.

Cleaning Material	Requirements
Latex gloves or finger cots	Powder free
Air bulb	Clean air bulb
Ethyl or isopropyl alcohol	Spectroscopic or reagent grade
Acetone	Spectroscopic or reagent grade
Lens wipe (preferred)	Optical (cleanroom) quality
Cotton balls or cotton swabs	High-quality surgical cotton/high-quality paper-bodied

Maintenance/ Troubleshooting

Maintenance

Cleaning optics

- 1 Shut off and lock out all power to the laser. You must verify that the laser is OFF (in a zero-energy state) before continuing with the optical inspection!
- 2 Visually inspect all optical surfaces in the beam path for contaminants.
- 3 Remove loose contaminants from the optic by holding a clean air bulb at an angle to the optic and blow a stream of air at a glancing angle across the lens surface. Repeat as necessary.
- 4 Dampen a lens wipe with the selected cleaning agent. Alcohol (least aggressive) is best for initial surface cleaning. Acetone (moderately aggressive) is best for oily residue or minor baked-on vapors and debris.
- 5 Gently, and without applying pressure, drag the damp lens wipe across the optical surface in a single pass. Do not rub or apply any pressure, especially when using a cotton swab. Drag the wipe without applying any downward pressure.
- 6 Carefully examine the optic under suitable lighting. Certain contaminants or damage such as pitting cannot be removed. In these cases the optic must be replaced to prevent catastrophic failure.
- 7 Repeat Steps 4 through 6 as required, removing all traces of contaminants and deposits.

**Important
Note:**



If acetone is used as a cleaning solvent, a second follow-up cleaning of the optical surface using alcohol is required to remove any acetone residue.

Use a clean lens wipe on each pass. The wipe will pick up and carry surface contaminants that may scratch optical surfaces or coatings if reused.

Caution

Possible
Equipment
Damage



Do not allow the nozzle of the air bulb to touch the optical surface. Any contact may damage the optic by scratching coatings on the optical surface.

Do not use compressed shop air to blow contamination from the optic. Compressed air contains significant amounts of water and oil that form adsorbing films on the optical surface.

Do not exert pressure on the surface of the optic during cleaning. Optical surfaces and coatings are easily scratched by dislodged contaminants.

Use a **new lens wipe on each pass** as contaminants picked up by the wipe may scratch the optical surface.

Maintenance/ Troubleshooting

Troubleshooting

Troubleshooting

- Introduction
- Resetting faults
- Laser faults
- Beam delivery optics

Troubleshooting Introduction

This section is designed to help isolate problems to the module level only. Problems on circuit boards or the laser tube are not within the scope of this guide because they are not user-serviceable assemblies; do not attempt to repair them. Contact SYNRAD® or a SYNRAD Authorized Distributor for repair or replacement information.

To troubleshoot the 32-1 laser, it is necessary to understand the sequence of events that must happen before the laser can turn on and operate. Before you attempt to perform any service, we advise you to read the entire troubleshooting guide and review the relevant schematic diagrams. Symptoms and possible causes are highlighted by dark print and bullet points throughout this section. Information about each symptom and cause can be found in the paragraphs following each heading.

Caution

Possible Equipment Damage



Attempting repair of a SYNRAD laser without the express authorization of SYNRAD, will void the product warranty. If troubleshooting or service assistance is required, please contact SYNRAD Customer Service.

The Power-On Reset feature is not available on OEM models; OEM customers must provide this required safety feature as part of their equipment integration.

During any fault shutdown, the Fault Shutdown Output (Pin 1 on the DB-9 Connector), which is normally at +15 VDC, latches to a low state (0 VDC) until the laser is reset by removing DC power for 30 seconds and then reapplying power to the laser.

Each Symptom listed below describes a particular fault condition. For each Symptom, specific causes and solutions are described in the Possible Causes section.

Symptom:

- No output beam, but +30 VDC is applied.

Maintenance/ Troubleshooting

Troubleshooting

Possible Causes:

- A fault shutdown has occurred. Pin 1 on the DB-9 Connector is at 0 VDC in reference to Pin 2 (Pin 1 is at +15 VDC during normal operation).

An over temperature, overvoltage/undervoltage, or RF circuitry failure has occurred.

Correct the problem(s), then remove power from the laser for 30-seconds. Re-apply power (if a Keyswitch has been added through the DB-9 jumper plug), cycle the Keyswitch or Remote Keyswitch.

Beam delivery optics

Symptom:

- The laser appears to slowly lose power over time; laser output power must be increased to maintain previous performance.

Possible Causes:

- Beam delivery optics are coated by vapor residue or debris.

Shut down the laser and carefully inspect each optic in the beam delivery path, including the laser's output coupler. Remember that optics are fragile and must be handled carefully; preferably by the mounting ring only. If the optic requires cleaning, refer to the required cleaning materials table earlier in this chapter, then refer back to Maintenance for cleaning instructions. Use only recommended cleaning materials to prevent scratching delicate optical surfaces.

If the focusing optic is pitted, it must be replaced immediately. The laser's high power density will cause pits or debris on the lens to absorb enough energy that the lens may crack. If this happens, other optics in the beam path may be contaminated or damaged as well.

When the application requires air (instead of nitrogen or argon) as an assist gas, we recommend the use of breathing quality air available in cylinders from a welding supply company. Because compressed shop air contains minute particles of oil and other contaminants that will damage optical surfaces, it must be carefully filtered and dried before use as a purge or assist gas. Refer to Assist gas purity specifications, in the Technical Reference chapter for filtering specifications.

Caution Possible Equipment Damage



If you operate your laser or marking head in a dirty or dusty environment, contact SYNRAD® about the risks of doing so and the precautions you can take to increase the longevity of your laser.

Maintenance/ Troubleshooting

Troubleshooting

Input/Output/Fault Conditions



LASER CONDITION / FAULT	INPUT STATUS		OUTPUT STATUS		
	Remote Key	PWM	Fault	Ready LED	Lase LED
DB-9 pins	6 to 7	3 to 4	1	9	8
DC Power Off	X	X	L		
DC Power Applied Laser Not Enabled	O	X	H	ON	
Laser enabled, no tickle or PWM	C	None	H	ON	
Tickle Applied	C	Tickle	H	ON	Tickle
Laser Firing	C		H	ON	
Over Temp Fault	X	X	L		
Under Voltage Fault	X	X	L		
Over Voltage Fault	X	X	L		
TABLE KEY:	C = circuit closed O = circuit open x = Does not matter		L = output low H = output high/open		

Table 5-2 Input/Output/Fault Conditions for the 32-1 series lasers.

Chapter Index

A

American National Standards Institute (ANSI) 18
Assist gas purity
specifications, 29, 31, 32

C

Caution
condensation, 5, 27, 30, 33, 41, 52, 54, 55, 56
CDRH 21
Class IV safety features 24
Code of Federal Regulations (CFR) 21, 22
Customer Service 8

D

Daily inspections 51
DC Power cable 51
Dew point
chart, 43
Disabling Firestar 51

F

Food and Drug Administration (FDA) 21

H

Hazard information 15
label locations, 20
terminology, 15

I

Inspections
daily, 51

L

Label locations 20
Laser Institute of America (LIA) 19

M

Maintenance
daily inspections, 51
disabling Firestar, 51
storage/shipping, 52

O

Occupational Safety and Health Administration (OSHA) 19

R

Reference materials 8
RoHS 23

S

Sales and Applications 8
Specifications
assist gas purity, 29, 31, 32
Storage/shipping 52

T

Technical Support 8
Trademark information 6
Troubleshooting 52

U

User I/O
connection summary, 42
User I/O connections
input/output signals 42

W

Warranty information 7

Tables and Figures

Figure 1-1 32-1 Ship kit contents.....	11
Table 1-1 32-1 ship kit contents.....	11
Figure 1-2 Anatomy of a model number.....	13
Figure 2-2 Always wear safety glasses.	18
Figure 2-3 38-1 Hazard label locations.....	20
Table 2-1 Class 4 safety features as required by CDRH and EN.....	24
Table 2-2 European Union Directives.....	25
Figure 2-5 32-1 Declaration Document.	26
Figure 4-1 Beam characteristics.	29
Figure 4-2 "Flying optics" beam path.	31
Table 4-2 Assist gas purity specifications.....	32
Table 4-3 Input signal specifications.....	33
Table 4-4 Tickle pulse specifications.....	34
Figure 4-3 Tickle pulse waveform.....	34
Figure 4-4 32-1-2 Laser Output waveform.	35
Figure 4-5 32-1-5 PWM Input.	36
Figure 4-6 PWM signal waveform.....	38
Table 4-5 PWM signal specifications.....	38
Figure 4-7 Physical layout of 32-1 DB-9 Connector.....	42
Table 4-6 DB-9 pin assignments.....	43
Pin#.....	43
Table 4-7 DB-9 Connector input signal specifications.....	44
Table 4-8 DB-9 Connector output signal specifications.....	44
Figure 4-8 Remote Keyswitch circuit.....	45
Figure 4-9 Remote Ready output to PLC input (PLC sourcing).....	46
Figure 4-10 Fault Shutdown Output to PLC input.....	46
Table 4-9 Model 32-1 general specifications.....	48
Figure 4-11 Model 32-1 package outline and mounting dimensions, 1 of 1.	49
Table 5-1 Required cleaning materials.	53
Table 5-2 Input/Output/Fault Conditions for the 32-1 series lasers.....	57