



ARGES System Controller, ARGNET Series, Model ASC-1, ASC-2 V41, ASC-6 V41

User Manual



Read carefully before using.
Retain for future reference.

Manufacturer

Novanta Europe GmbH
Werk 4
92442 Wackersdorf
Germany
Phone: +49-9431-7984-0
Email: Photonics@Novanta.com

Customer service

Before contacting us for assistance, please review appropriate sections in this manual that may answer your questions. After consulting the manual, please submit a request through our website: <https://novantaphotonics.com/technical-support-request-form-header/>

Americas, Asia Pacific

Novanta Headquarters
Bedford, USA
Phone: +1-781-266-5700
Email: Photonics@Novanta.com

China

Novanta Sales & Service Office
Shenzhen, China
Phone: +86-755-8280-5395
Suzhou, China
Phone: +86-512-6283-7080
Email: Photonics.China@Novanta.com

Europe, Middle East, Africa

Novanta Europe GmbH
Wackersdorf, Germany
Phone: +49-9431-7984-0
Milan, Italy
Phone: +39-039-793-710
Email: Photonics@Novanta.com

Japan

Novanta Service & Sales Office
Tokyo, Japan
Phone: +81-3-5753-2460
Email: Photonics.Japan@Novanta.com

Table of Contents

1. How to use this document	1
1.1. Symbols and signal words	1
1.2. Notation conventions	2
1.3. Storage and replacement	3
1.4. Specifics and structure	3
1.5. Target audience and qualification	3

2. General safety instructions	5
2.1. Disambiguation of term 'laser unit'	5
2.2. Intended use	5
2.3. Reasonably foreseeable misuse	6
2.4. Hazards	6
2.4.1. Laser radiation	7
2.4.2. Laser generated air contaminants	7
2.4.3. Ultrashort pulse laser generated UV radiation	7
2.4.4. Ultrashort pulse laser generated X-ray radiation	8
2.4.5. Hot laser-processed material	8
2.4.6. Electrostatic discharge	9
2.5. Modifications and spare parts	10
2.6. Fire extinguisher recommendation	10

3. Overview	11
3.1. Function	11
3.2. Model ASC-1	12
3.2.1. Labeling	12
3.2.2. Interfaces	13
3.2.3. Controls and indicator	14
3.3. Model ASC-2 V41	16
3.3.1. Labeling	16
3.3.2. Interfaces	17

3.3.3. Controls and indicators	18
3.4. Model ASC-6 V41	20
3.4.1. Labeling	20
3.4.2. Interfaces	21
3.4.3. Controls and indicators	23

4. Preparing for use	25
4.1. Transporting and storing	25
4.2. Unpacking and verifying the scope of delivery	25
4.3. Installing	27
4.3.1. Incorporating the ASC into a laser unit	27
4.3.2. Connecting to the LAN or PC	32
4.3.3. Alternatively to LAN: Connecting to WLAN	33
4.3.4. Connecting the data line to the scan head	33
4.3.5. Connecting the power supply to the scan head	35
4.3.5.1. Model ASC-1	35
4.3.5.2. Models ASC-2 V41, ASC-6 V41	36
4.3.6. Connecting the laser fiber to the scan head	38
4.3.7. Connecting the laser (omit this if a laser is incorporated)	38
4.3.8. Connecting safety relevant devices to the ASC-6 V41	41
4.3.9. Optionally connecting a programmable logic controller	43
4.3.10. Optionally connecting position encoders	49
4.3.11. Optionally connecting a serial or CAN device	51
4.3.12. Optionally connecting EtherCAT devices	53
4.3.13. Optionally connecting a PROFIBUS master device	54
4.3.14. Optionally connecting other devices	56
4.3.15. Optionally connecting USB 3.1 devices	59
4.3.16. Optionally connecting USB 2.0 devices	60
4.3.17. Optionally connecting the internal laser to the Ethernet	60
4.3.18. Connecting mains supply	61
4.3.18.1. Models ASC-1, ASC-2 V41	61
4.3.18.2. Model ASC-6 V41	63
4.3.19. Remote On/Off	64
4.4. Commissioning	65
4.4.1. Changing the network settings	65

Table of Contents

4.4.2. Completing the commissioning via the InScript software 67

5. Operating 68

5.1. Protection of persons 68

5.2. Emergency measures 68

5.3. Observable signals 68

5.4. Operational procedures 68

5.4.1. Starting up 68

5.4.2. Operating 69

5.4.3. Shutting down 70

5.5. Troubleshooting 71

6. Cleaning, maintaining, and repairing 78

6.1. Maintenance plan 78

6.2. Model ASC-1 79

6.2.1. Replacing the air filters 79

6.2.2. Replacing the battery 80

6.3. Models ASC-2/-6 V41 82

6.3.1. Replacing the air filters 82

6.3.2. Replacing the battery 83

6.4. Cleaning the fiber tips 85

6.5. Installing firmware- or FPGA-update 86

7. Decommissioning, returning, disposal 87

7.1. Decommissioning 87

7.2. Returning 88

7.3. Disposal 89

A. Appendix 90

A.1. Spare parts 90

A.2. Further reading 91

A.3. Third party software licenses 91

A.4. Declaration of conformity 96

List of Figures

- 3.1. ASC-1: Positioning of labels at the front 12
- 3.2. ASC-1: Positioning of labels at the rear 12
- 3.3. ASC-1: Positioning of interfaces at the front 13
- 3.4. ASC-1: Positioning of interfaces at the rear 13
- 3.5. ASC-1: Positioning of controls and indicators at the front 14
- 3.6. ASC-1: Positioning of indicators at the rear 14
- 3.7. ASC-2 V41: Positioning of labels at the rear 16
- 3.8. ASC-2 V41: Positioning of interfaces at the rear 17
- 3.9. ASC-2 V41: Positioning of controls and indicators at the front 18
- 3.10. ASC-2 V41: Positioning of indicators at the rear 19
- 3.11. ASC-6 V41: Positioning of labels at the rear 20
- 3.12. ASC-6 V41: Positioning of interfaces at the rear 21
- 3.13. ASC-6 V41: Positioning of interfaces at the rear, detail 22
- 3.14. ASC-6 V41: Positioning of controls and indicators at the front 23
- 3.15. ASC-6 V41: Positioning of indicators at the rear, detail 24

- 4.1. ASC-1: Dimensions and mounting 29
- 4.2. ASC-2 V41: Dimensions and mounting 30
- 4.3. ASC-6 V41: Dimensions and mounting 31
- 4.4. Connecting a npn-PLC to the PLC and PLC AUX connector 48
- 4.5. Connecting a pnp-PLC to the PLC and PLC AUX connector 48
- 4.6. Connecting a SIEMENS S5 PLC to the PLC and PLC AUX conn. 49
- 4.7. GPIO interface: Circuit diagram excerpt at input side 58
- 4.8. GPIO interface: Circuit diagram excerpt f. output volt. switching 59
- 4.9. GPIO interface: Circuit diagram excerpt at output side 59

List of Tables

4.1.	Environmental conditions for transport and storage	25
4.2.	Environmental conditions for installation and operation	28
4.3.	Physical	28
4.4.	ASC-1: Pin assignment of the scan head power supply	36
4.5.	ASC-2 V41: Pin assignment of the scan head power supply	38
4.6.	ASC-6 V41: Laser parameter	38
4.7.	Pin assignment of the LASER interface	39
4.8.	Assignment of Generic Laser Cable's BNC connectors to signals	41
4.9.	ASC-6 V41: Pin assignment of the "safety" connector	42
4.10.	Pin assignment of the PLC interface	44
4.11.	Pin assignment of the PLC AUX interface	46
4.12.	Pin assignment of the position encoder interface	50
4.13.	Pin assignment of the IOIOI interface when used as RS-232/CAN interface	52
4.14.	Pin assignment of the IOIOI interface when used as RS-485/CAN interface	52
4.15.	Pin assignment of the ETHERCAT interface	54
4.16.	Pin assignment of the PROFIBUS interface	55
4.17.	Pin assignment of the GPIO interface	56
4.18.	ASC-1, ASC-2 V41: Mains supply	61
4.19.	ASC-6 V41: Mains supply	63
4.20.	ASC-6 V41: Pin assignment of the mains supply connector	64
4.21.	Pin assignment of the Remote On/Off interface	65
5.1.	Troubleshooting	72
5.2.	Meaning of the ARGES-head button LEDs	72
5.3.	Meaning of the 3 LEDs at the front side's center	73
5.4.	Meaning of the LED-group PLE	73
5.5.	Meaning of the LED-group GPU	73
5.6.	Meaning of the LEDs at the ARGNET interface	74
5.7.	Meaning of the LEDs at the DATA interface	74
5.8.	Meaning of the LED-group PWR	74
5.9.	Meaning of the LEDs at the Ethernet interface	75
5.10.	Meaning of the LEDs at the EtherCAT interfaces	75
5.11.	Meaning of LED-group EC below the EtherCAT interface	75
5.12.	Meaning of the LED-group SYS while booting	76

5.13. Meaning of the LED-group SYS while halting	77
6.1. Maintenance plan	78
A.1. List of spare parts	90

1. How to use this document

1.1. Symbols and signal words

Please be sure that you understand the meanings of the symbols and signal words described below before you move on.

DANGER

... indicates an imminently hazardous situation which, if not avoided, will result in death or serious injury.²

WARNING

... indicates a potentially hazardous situation which, if not avoided, could result in death or serious injury.³

CAUTION

... indicates a potentially hazardous situation which, if not avoided, could result in minor or moderate injury.⁴

²Serious injury includes blindness, wounds, burns (low and high temperature), electric shock, fractures, and poisoning, etc. which have long-lasting consequences or require hospitalization and/or long-term treatment.

³Serious injury includes blindness, wounds, burns (low and high temperature), electric shock, fractures, and poisoning, etc. which have long-lasting consequences or require hospitalization and/or long-term treatment.

⁴Minor or moderate injury includes wounds, burns, electric shock, etc. not requiring hospitalization and/or long-term treatment.

NOTICE

... indicates a potentially hazardous situation which, if not avoided, could result in property damage and other problems, but not personal injury.

IMPORTANT

... indicates an important information.

TIP

... indicates a practice which facilitates work.

Procedure

... indicates a call to action. After this signal word you must execute one or more steps. We made an exception for warnings where we omitted this signal word as avoidance procedures are mandatory there.

1.2. Notation conventions

This user manual uses the following notation conventions.

Table: Notation conventions

Notation	Meaning
<u>Underlined</u>	click-able cross reference or hyperlink (only visible on-screen)
[{(Number)}]	cross reference to a list of further reading on page 91
... and specifically in procedures:	
Bold	element in the graphical user interface that the user shall click
<i>Italic</i>	name of element in the graphical user interface or emphasized text
Typewriter	text to be typed in by the user, filename, or path

1.3. Storage and replacement

- Keep this user manual with the product to access it at any time during its lifetime.
- You can access the latest copy of this user manual on our website.
- This user manual is part of the product. If the product ownership changes then this user manual must accompany the product.

1.4. Specifics and structure

Novanta reserves the right to make changes to the product covered in this user manual to improve its performance, reliability, or manufacturability. Contents of this user manual are subject to change without notice.

Although every effort has been made to ensure the accuracy of the information contained in this user manual, Novanta assumes no responsibility for inadvertent errors.

This manual is limited to the product's period of life, beginning with its transport and storage, until its disposal.

- Be mindful of the environment, do not print this user manual unless necessary.

This PDF file forces duplex printing, if your printer can do that.

1.5. Target audience and qualification

IMPORTANT

Only the target audience, who are listed in the beginning of each instructing section in the following chapters, may perform the activities described there.

The people who perform these activities need to be of age.

The qualification of the target audience is defined below.

Laypersons without special qualification, who e. g. transport and store the boxed product.

Operators, who are trained by the company that is operating the laser unit that contains the product, in the use of that laser unit and who confirmed the training by signature.

Experts in electrical engineering or mechatronics with successful training in handling highly sensitive electronic and optical equipment. Experts must be trained by the company that is operating the laser unit that contains the product in the use of that laser unit.

2. General safety instructions

This chapter lists important precautions that users of the product (and other persons) must observe to avoid injury and damage to property and to ensure safe and correct use of the product.

2.1. Disambiguation of term 'laser unit'

A *laser unit* is a machine that incorporates a laser device (that is the actual laser), the product and other components.

2.2. Intended use

The controller is delivered as an OEM component for integration into a laser unit that uses a class 4 laser and that will be operated in a dry and clean indoor environment without electrically conductive contamination.

- Before installing and operating the controller, carefully read this document for your protection.
- Retain this document for future reference.

IMPORTANT

Novanta has no influence over the employed laser device or the overall laser unit.

- Customers assume full responsibility for implementing and maintaining a laser-safe working environment.
- Original equipment manufacturer (OEM) customers assume full responsibility for CDRH (Center for Devices and Radiological Health) certification and compliance with the standards and guidelines required for the CE (European Conformity) label.
- Please contact Novanta for further information about the product and applicable guidelines.

2.3. Reasonably foreseeable misuse

It is considered a misuse if you use the controller without incorporating it into a laser unit that complies with the standards required for the CE (European Conformity) label.

2.4. Hazards

IMPORTANT

- Follow the control measures and safety guidelines provided by the laser's manufacturer, and those established by your Laser Safety Officer (LSO), Radiation Safety Officer (RSO), or safety department of your business or institution.

2.4.1. Laser radiation



WARNING

Laser radiation

can cause severe retinal and corneal burns, burns to the skin, and may pose a fire risk.

- To avoid injury and reduce risk of fire, follow the control measures and safety guidelines provided by the laser's manufacturer, and those established by your Laser Safety Officer (LSO), Radiation Safety Officer (RSO), or safety department of your business or institution.

2.4.2. Laser generated air contaminants

During laser material processing, matter is being evaporated. Laser generated air contaminants can compose of multitude hazardous products, such as nickel, chrome, alumina, zinc, butanol, toluol, xylene, and formaldehyde. The concentration, size, and the quantity of these aerosols and particles can vary.



WARNING

Laser generated air contaminants, even if respired in lowest concentrations over long time or brought to skin contact,

can cause skin irritations, contact eczema, sickness, vomiting, cauterization of the respiratory tract, nervous diseases, allergic reactions, spasms, and cancer.

- To avoid injury, follow the control measures and safety guidelines provided by the respective material safety datasheet, and those established by your Laser Safety Officer (LSO), Radiation Safety Officer (RSO), or safety department of your business or institution.

2.4.3. Ultrashort pulse laser generated UV radiation

Under certain circumstances ultrashort pulse lasers can induce UV radiation that is being emitted from the point where the material is being processed.

 **WARNING**

UV radiation emitting from the processing point can cause burns to the skin and skin cancer.

- To avoid injury, follow the control measures and safety guidelines provided by the laser's manufacturer, and those established by your Laser Safety Officer (LSO), Radiation Safety Officer (RSO), or safety department of your business or institution.

2.4.4. Ultrashort pulse laser generated X-ray radiation

If the irradiance limit is exceeded during materials processing, ultrashort pulse lasers can induce X-ray radiation that is being emitted from the point where the material is being processed.

 **WARNING**

If the irradiance limit is exceeded, X-ray radiation emitting from the processing point.

This can cause clouding of the lens inside the eye (Cataract) and cancer.

- To avoid injury, follow the control measures and safety guidelines provided by the laser's manufacturer, and those established by your Laser Safety Officer (LSO), Radiation Safety Officer (RSO), or safety department of your business or institution.

2.4.5. Hot laser-processed material

During materials processing with lasers, strong heating of the processed material may arise.

 **CAUTION**

Hot laser-processed material can cause skin burns.

- If you are a system integrator, then place a sign at the laser processing area that warns about hot surfaces.
- When handling material by hand that was laser-processed shortly before then wear heat resistant protective gloves.

2.4.6. Electrostatic discharge

 **NOTICE**

Electrostatic discharge (ESD) can damage the controller.

- Transport equipment only in anti-static packaging and a packaging equivalent to that received with the shipment.
- Keep the controller sealed until within an ESD-controlled environment.

A proper static control station should include:

- A soft grounded conductive tabletop or grounded conductive mat on the tabletop
- A grounded wrist strap with the appropriate (1 M Ω) series resistor connected to the tabletop mat and ground
- An adequate earth ground connection, such as an uncoated water pipe or AC ground
- Conductive bags, trays, totes, racks, or other storage
- Properly grounded power tools
- Personnel handling ESD items must wear ESD protective garments and ground straps

2.5. Modifications and spare parts

Modifications to the controller are not permitted.

Spare parts specified, supplied or approved by Novanta are only permitted for use with this controller.

2.6. Fire extinguisher recommendation

- Use a carbon dioxide (CO₂) fire extinguisher.
- Ensure the fire extinguisher used is compatible with the entire laser unit.
- Prior to installing the controller, ensure the fire extinguisher is available and observe its instructions for use including its hazard notes.

3. Overview

3.1. Function

An ARGES system controller (ASC) is the central device in a laser system. It controls scan heads, lasers, sensors, actuators and other peripherals. A combination of highly configurable interfaces and processing units responds in real-time to external signals. In this manner the ASC guarantees an optimized synchronization of all devices and signals, which is important in laser systems.

The ASC is an autonomously functioning device that does not require a host to carry out its processing tasks. It can be remotely diagnosed, administered and parameterized via Ethernet TCP/IP.

The control environment includes the InScript software, which is supplied with the ASC, as well as other software-based connectivity solutions, e.g. the ControllerLib. These alternative control options provide a high degree of flexibility for precisely configuring the system to your requirements.

The *InScript* software provides a simple object driven task assembly structure combined with detailed control parameter inputs when required. It is a powerful tool for creating process sequences and for system management.

The *ControllerLib* is the application programming interface (C/C++ based shared library and DLL) which can be used to control most of the ASC's functionality from your own applications.

3.2. Model ASC-1

3.2.1. Labeling



Figure 3.1.: ASC-1: Positioning of labels at the front

Legend to figure 3.1



No.	Label	Description
1		Warranty seal (hidden behind the oval grid)



Figure 3.2.: ASC-1: Positioning of labels at the rear

Legend to figure 3.2

No.	Label	Description
1		Type plate with product designation, electrical supply data, serial number, manufacturing year and manufacturer's address

3.2.2. Interfaces



Figure 3.3.: ASC-1: Positioning of interfaces at the front

Legend to figure 3.3

No.	Labeling / function	See section	On page
1	USB 3.1 type C	4.3.15	59

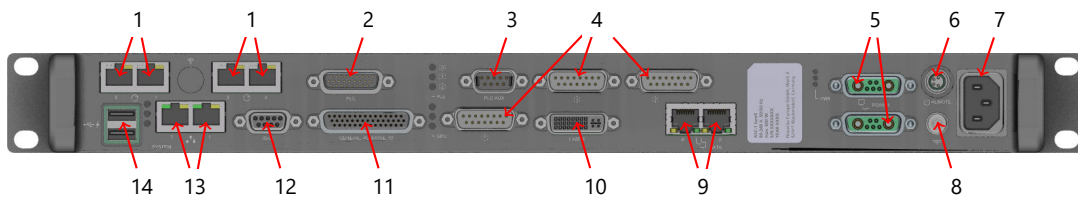
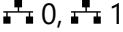



Figure 3.4.: ASC-1: Positioning of interfaces at the rear

Legend to figure 3.4

No.	Labeling / function	See section	On page
1	⊙ 0, ⊙ 1, ⊙ 2, ⊙ 3	4.3.4	33
2	PLC	4.3.9	43
3	PLC AUX	4.3.9	43
4	⊙ 0, ⊙ 1, ⊙ 2	4.3.10	49
5	⏻ POWER A, ⏻ POWER B	4.3.5	35
6	⏻ REMOTE	4.3.19	64
7	Mains supply connector	4.3.18	61
8	Grounding thread insert	4.3.18	61
9	⏻ DATA A, ⏻ DATA B	do not connect, use no. 1 instead	

No.	Labeling / function	See section	On page
10	LASER	4.3.7	38
11	GENERAL PURPOSE I/O	4.3.14	56
12	IOIOI	4.3.11	51
13	 0,  1	4.3.2	32
14		4.3.16	60

3.2.3. Controls and indicator

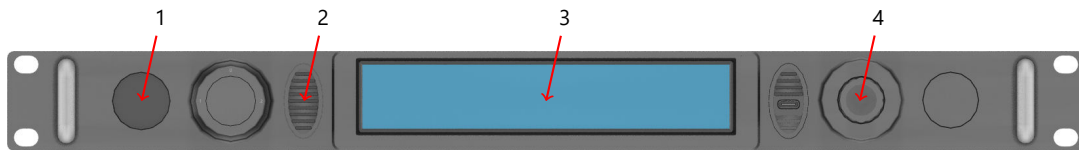

Figure 3.5.: ASC-1: Positioning of controls and indicators at the front

Legend to figure 3.5

No.	Labeling / function	See section	On page
1	Standby/on push-button (ARGES-head)	5.4.1 5.4.3	68 70
2	Speaker	5.3	68
3	Display	5.4.2	69
4	Joystick	5.4.2	69

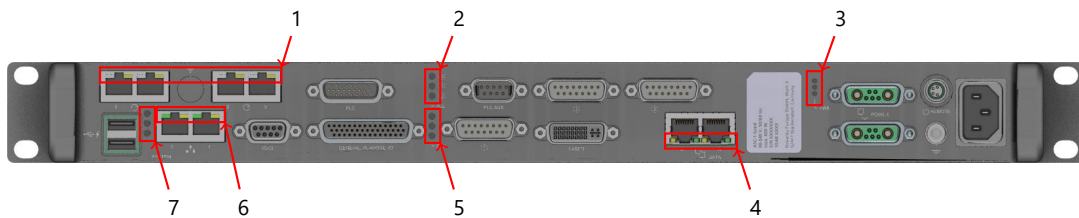

Figure 3.6.: ASC-1: Positioning of indicators at the rear

Legend to figure 3.6

No.	Labeling / function	See table	On page
1	⊙ 0, ⊙ 1, ⊙ 2, ⊙ 3	5.6	74
2	PLE	5.4	73
3	PWR	5.8	74
4	□ DATA A, □ DATA B	5.7	74
5	GPU	5.5	73
6	■ 0, ■ 1	5.9	75
7	SYS	5.12 5.13	76 and 77

3.3. Model ASC-2 V41

3.3.1. Labeling

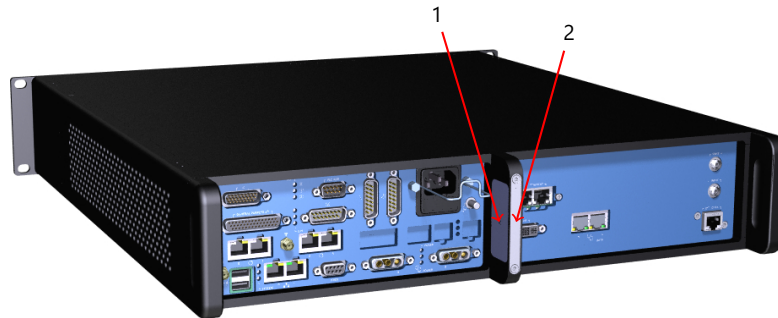

Figure 3.7.: ASC-2 V41: Positioning of labels at the rear

Legend to figure 3.7

No.	Label	Description
1	<p>ASC-2-V41-WFI 100–240 V, 50/60 Hz, max. 750 W</p> <p>S/N #####</p> <p>ARGES GMBH, WERK 4, 92442 WACKERSDORF GERMANY WWW.ARGES.DE</p>	Type plate with product designation, electrical supply data, serial number and manufacturer's address
2	<p>WARRANTY VOID IF SEAL IS BROKEN</p>	Warranty seal

3.3.2. Interfaces

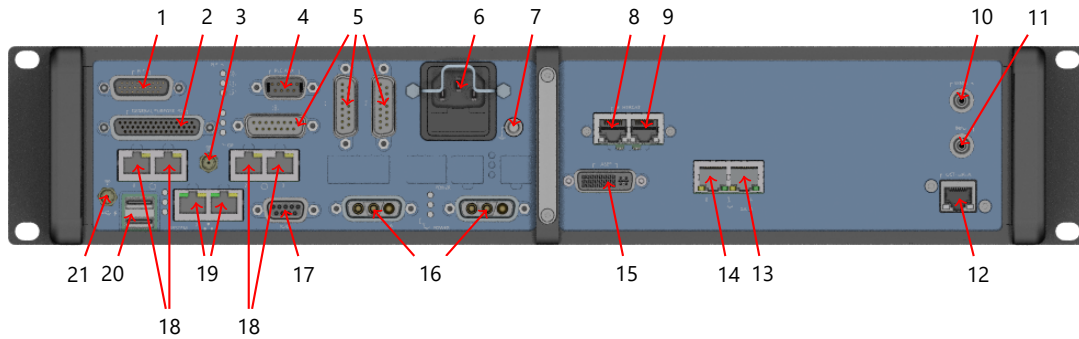



Figure 3.8.: ASC-2 V41: Positioning of interfaces at the rear

Legend to figure 3.8

No.	Labeling / function	See section	On page
1	PLC	4.3.9	43
2	GENERAL PURPOSE I/O	4.3.14	56
3	Wi-Fi	4.3.3	33
4	PLC AUX	4.3.9	43
5	{0}, {1}, {2}	4.3.10	49
6	Mains supply connector	4.3.18	61
7	Grounding thread bolt	4.3.18	61
8	ETHERCAT IN	4.3.12	53
9	ETHERCAT OUT	4.3.12	53
10	WFI SENSE		See [4]
11	WFI INPUT		See [4]
12	WFI DATA		See [4]
13	DATA A	4.3.4	33
14	DATA B	4.3.4	33
15	LASER	4.3.7	38
16	POWER	4.3.5	35
17	IOIOI	4.3.11	51
18	0, 1, 2, 3	4.3.4	33
19	0, 1	4.3.2	32

No.	Labeling / function	See section	On page
20		4.3.16	60
21		4.3.3	33

3.3.3. Controls and indicators

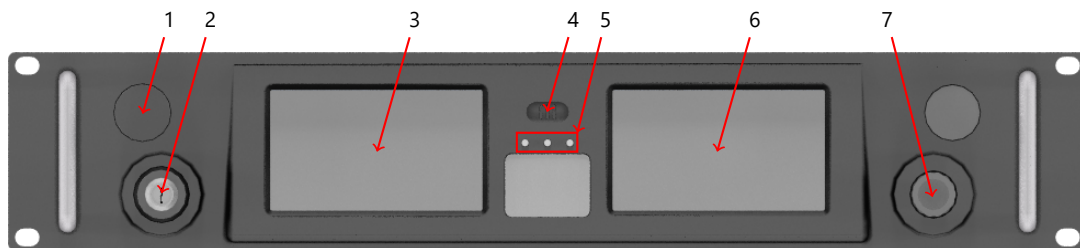

Figure 3.9.: ASC-2 V41: Positioning of controls and indicators at the front

Legend to figure 3.9

No.	Labeling / function	See section	On page
1	Standby/on push-button (ARGES head)	5.4.1	68 and
		5.4.3	70
2	Key switch	5.4.1	68
3	Left display	5.4.2	69
4	Speaker	5.3	68
5	LEDs	5.3	73
6	Right display	5.4.2	69
7	Joystick	5.4.2	69

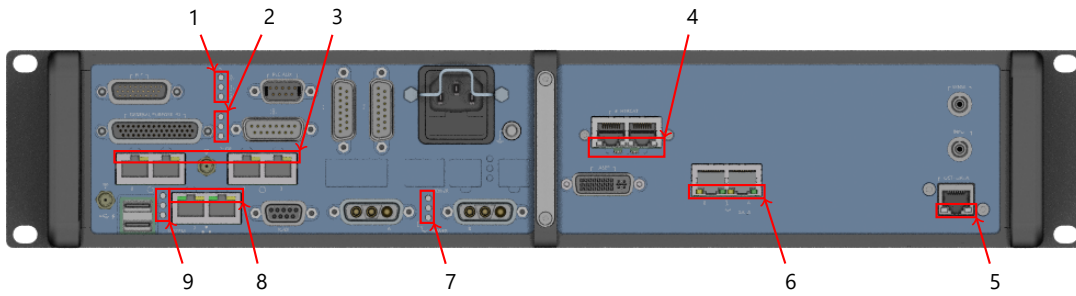

Figure 3.10.: ASC-2 V41: Positioning of indicators at the rear

Legend to figure 3.10

No.	Labeling / function	See table	On page
1	PLE	5.4	73
2	GPU	5.5	73
3	⊙ 0, ⊙ 1, ⊙ 2, ⊙ 3	5.6	74
4	ETHERCAT	5.10 5.11	75 and 75
5	WFI DATA		See [4]
6	□ DATA A, □ DATA B	5.7	74
7	PWR	5.8	74
8	■ 0, ■ 1	5.9	75
9	SYS	5.12 5.13	76 and 77

3.4. Model ASC-6 V41

3.4.1. Labeling



Figure 3.11.: ASC-6 V41: Positioning of labels at the rear

Legend to figure 3.11

No.	Label	Description
1	<p>ASC-6-V41-WFI-L200 90–264 V, 47–63 Hz, max. 2350 W</p> <p>S/N #####</p> <p>ARGES GMBH, WERK 4, 92442 WACKERSDORF GERMANY WWW.ARGES.DE</p>	Type plate with product designation, electrical supply data, serial number and manufacturer's address
2	<p>WARRANTY VOID IF SEAL IS BROKEN</p>	Warranty seal

3.4.2. Interfaces

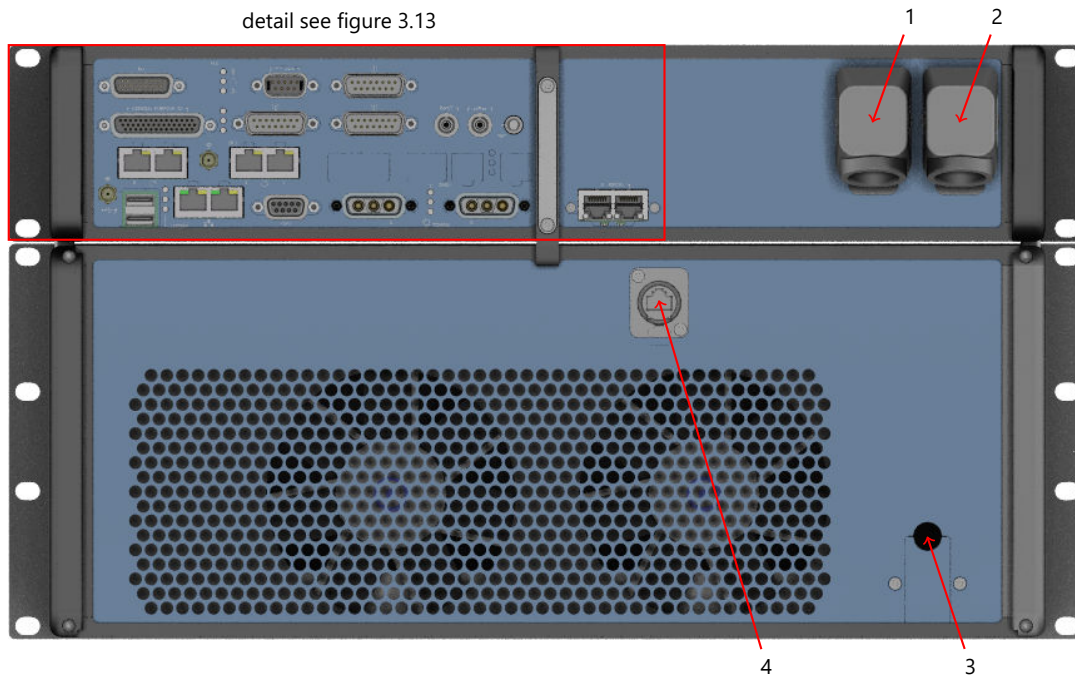

Figure 3.12.: ASC-6 V41: Positioning of interfaces at the rear

Legend to figure 3.12

No.	Labeling / function	See section	On page
1	Mains supply connector	4.3.18	61
2	“Safety” connector	4.3.8	41
3	Laser fiber	4.3.6	38
4	ETHERNET LASER	4.3.17	60

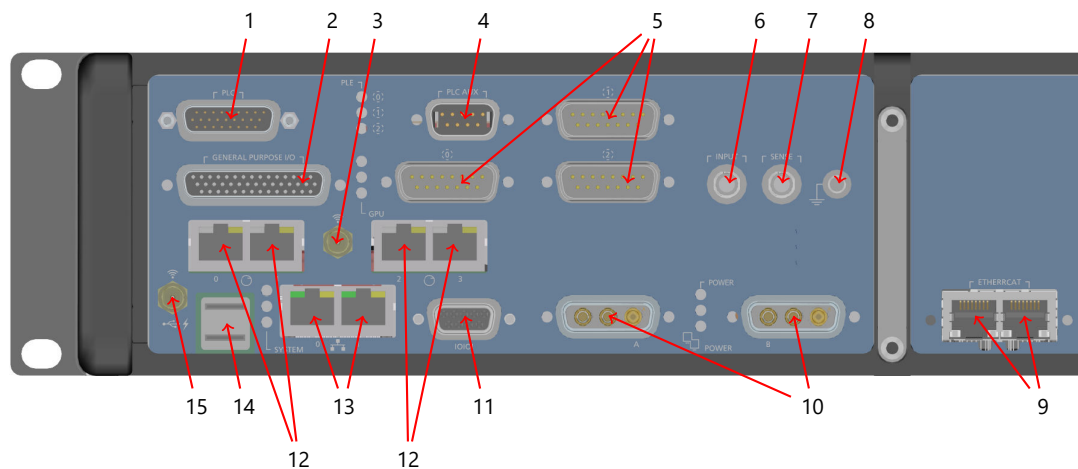

Figure 3.13.: ASC-6 V41: Positioning of interfaces at the rear, detail

Legend to figure 3.13

No.	Labeling / function	See section	On page
1	PLC	4.3.9	43
2	GENERAL PURPOSE I/O	4.3.14	56
3	📶	4.3.3	33
4	PLC AUX	4.3.9	43
5	{0}, {1}, {2}	4.3.10	49
6	INPUT		See [4]
7	SENSE		See [4]
8	Grounding bolt	4.3.18	61
9	ETHERCAT	4.3.12	53
10	☐ POWER A, ☐ POWER B	4.3.5	35
11	IOIOI	4.3.11	51
12	○ 0, ○ 1, ○ 2, ○ 3	4.3.4	33
13	⏏ 0, ⏏ 1	4.3.2	32
14	⚡	4.3.16	60
15	📶	4.3.3	33

3.4.3. Controls and indicators

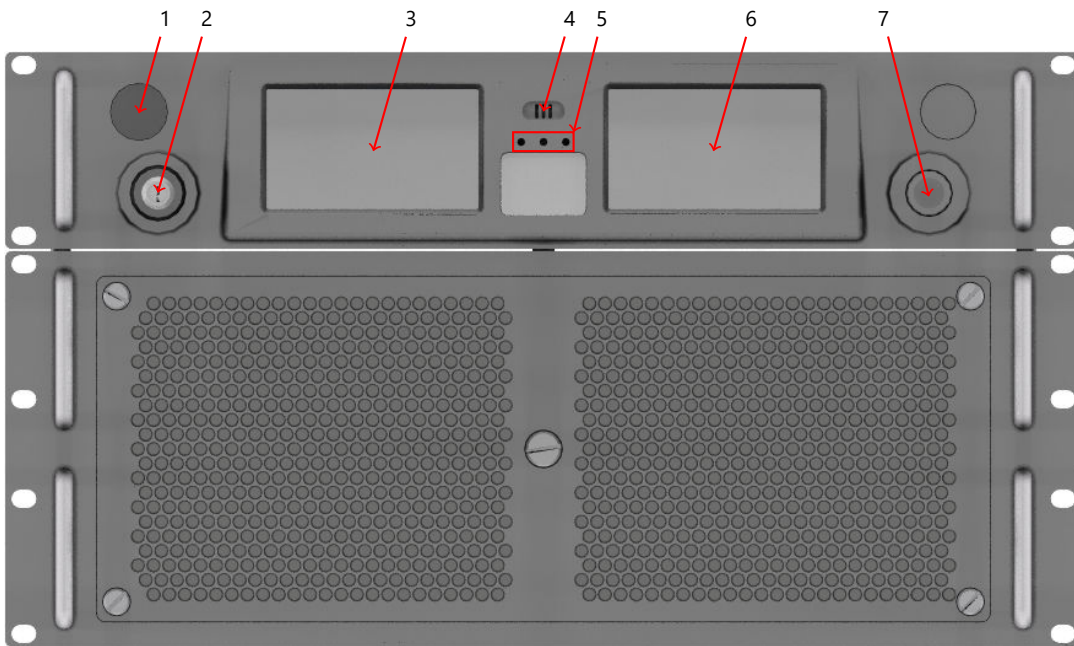

Figure 3.14.: ASC-6 V41: Positioning of controls and indicators at the front

Legend to figure 3.14

No.	Labeling / function	See section	On page
1	Standby/on push-button (ARGES head)	5.4.1	68 and
		5.4.3	70
2	Key switch	5.4.1	68
3	Left display	5.4.2	69
4	Speaker	5.3	68
5	LEDs	5.3	73
6	Right display	5.4.2	69
7	Joystick	5.4.2	69

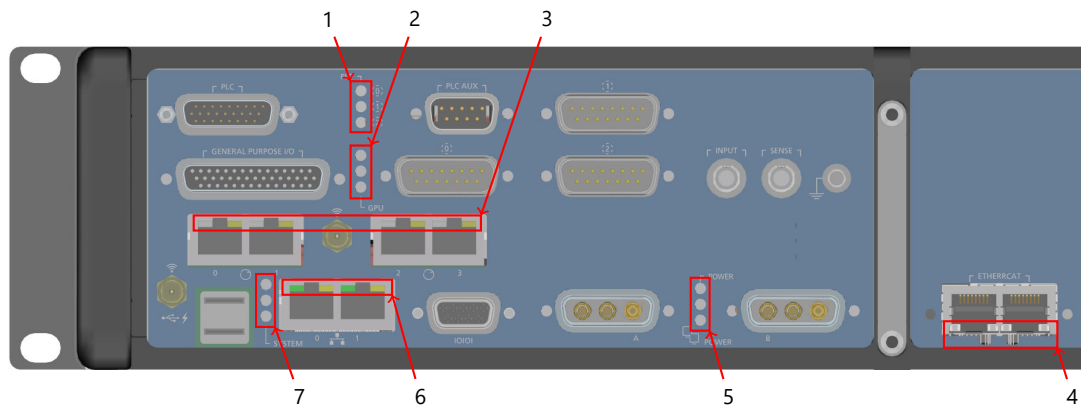

Figure 3.15.: ASC-6 V41: Positioning of indicators at the rear, detail

Legend to figure 3.15

No.	Labeling / function	See table	On page
1	PLE	5.4	73
2	GPU	5.5	73
3	0, 1, 2, 3	5.6	74
4	ETHERCAT	5.10 5.11	75 and 75
5	PWR	5.8	74
6	0, 1	5.9	75
7	SYS	5.12 5.13	76 and 77

4. Preparing for use

This chapter describes all procedures necessary to get the controller ready for use.

4.1. Transporting and storing

Target audience and qualification

Laypersons, operators and experts

Table 4.1.: Environmental conditions for transport and storage in the original packaging

Characteristic	Specification
Temperature	
Model ASC-1	-20 to 60 °C (253 to 333 K)
Model ASC-2 V41	0 to 50 °C (273 to 323 K)
Model ASC-6 V41	0 to 50 °C (273 to 323 K)
Humidity	10 to 80 % RH; non-condensing

Procedure

- Transport and store the scan head in its sealed original packaging or an equivalent packaging.

4.2. Unpacking and verifying the scope of delivery

Target audience and qualification

Experts

Procedure**TIP**

While unpacking the ASC keep in mind that you want to keep the packaging for future use.

1. Open the cardboard box.
2. Open the silver-colored aluminum composite bag.
3. Remove the upper foam insert.

**NOTICE**

Mechanical shock
can damage the ASC

- Handle the ASC with care and avoid mechanical shock.

The following notice applies to ASCs with incorporated fiber laser:

**NOTICE**

Damaged laser fiber
damages the incorporated fiber laser

- Follow the laser fiber manufacturer's instructions.
- Handle the laser fiber with care.
- Pay attention to the laser fiber's minimal bending radius.

4. Lift the still wrapped ASC from the cardboard box.
5. Remove the transparent, pink-colored, antistatic side gusseted bag.

The following notice applies to ASCs with incorporated fiber laser:

**NOTICE**

Contaminated or damaged fiber coupling damages the fiber and/or the laser.

- Leave the protective cap at the fiber coupling in place for now in order to keep the optics clean.

6. Check by the delivery note, whether all parts are present and in an evidently immaculate mechanical state.
7. Check whether the ASC serial number corresponds to the serial number written on the delivery note.
8. If this is not true then block the delivery and inform Novanta, please.
9. Keep the original packaging for future use.

4.3. Installing

4.3.1. Incorporating the ASC into a laser unit

Target audience and qualification

Experts

Have ready

- Screws suitable for mounting the controller in the laser unit; see figures 4.3.1 ff. on pages 29 ff.
- Suitable screwdriver, hexagon socket screw key set, Torx key set

Requirements

Table 4.2.: Environmental conditions for installation and operation

Characteristic	Specification
Environment	Install and operate the ASC only indoors in a dry and clean environment without conductive contamination.
Temperature	
Model ASC-1	0 to 40 °C (273 to 313 K)
Model ASC-2 V41	10 to 40 °C (283 to 313 K)
Model ASC-6 V41	10 to 40 °C (283 to 313 K)
Humidity	10 to 80 % RH; non-condensing

Table 4.3.: Physical

Characteristic	Specification
Width × height × length; mass	
Model ASC-1	482 mm × 44.4 mm × 268 mm; approx. 5 kg
Model ASC-2 V41	482 mm × 88.1 mm × 469 mm; approx. 10 kg
Model ASC-6 V41	482 mm × 265.9 mm × 546 mm; approx. 47 kg
Degree of protection by enclosure	IP20

4. Preparing for use

4.3. Installing

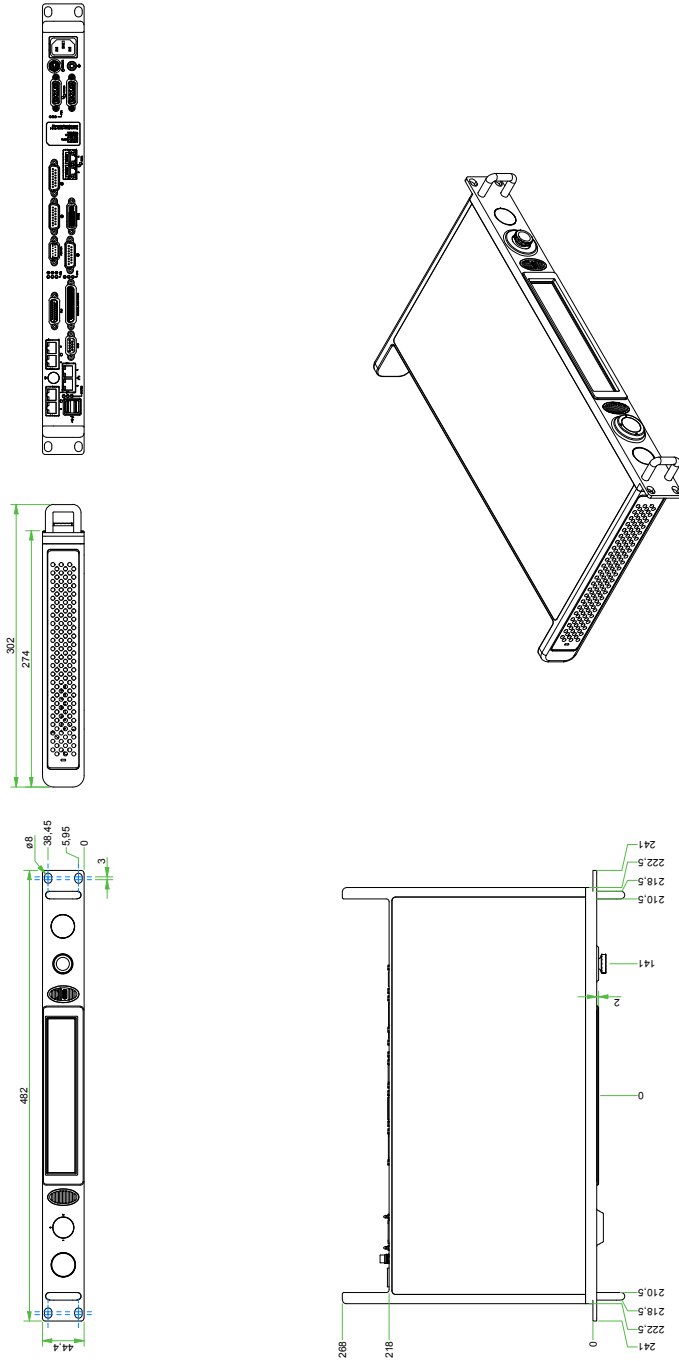

Figure 4.1.: ASC-1: Dimensions and mounting

4.3. Installing

4. Preparing for use

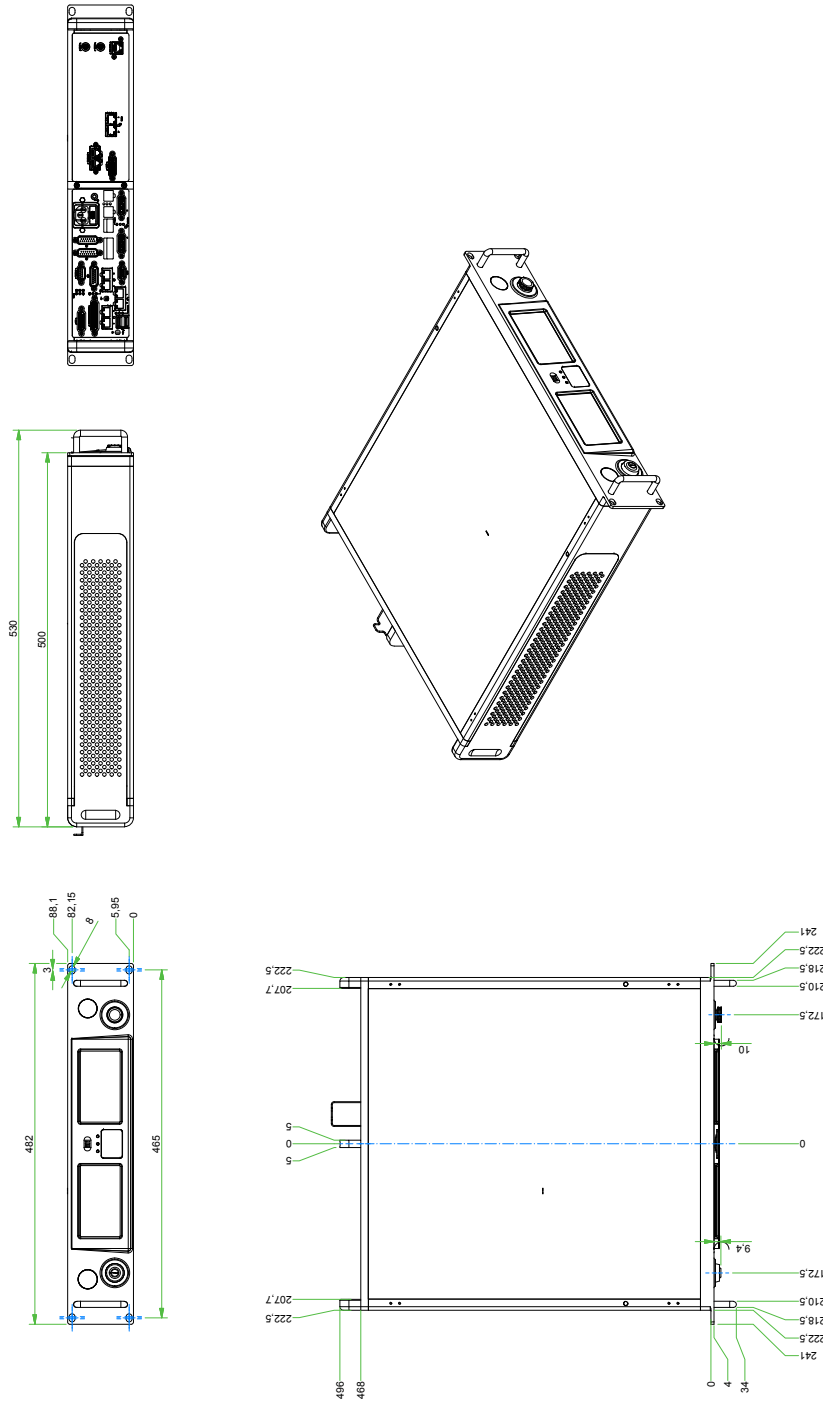

Figure 4.2.: ASC-2 V41: Dimensions and mounting

4. Preparing for use

4.3. Installing

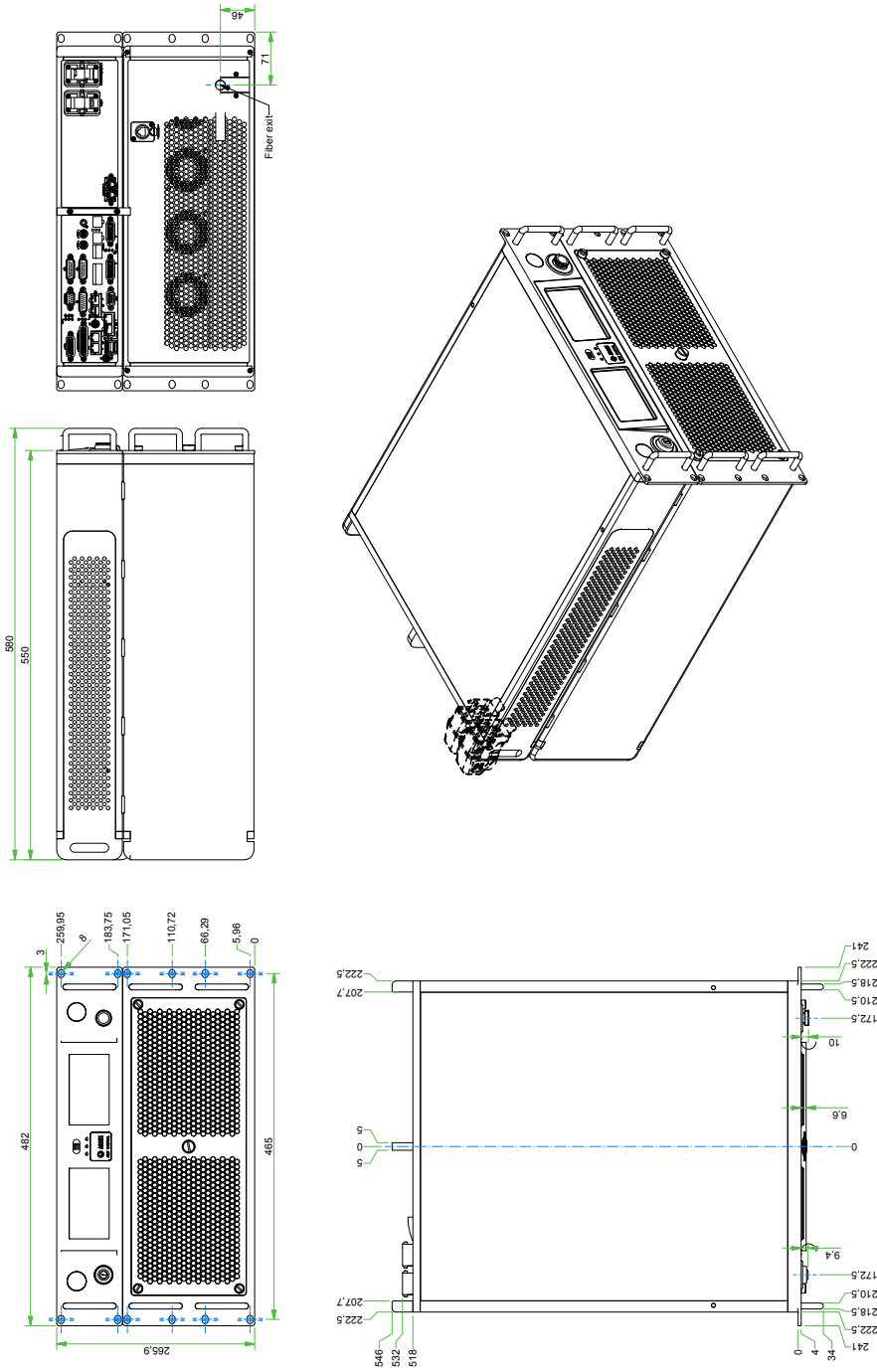

Figure 4.3.: ASC-6 V41: Dimensions and mounting

Safety precautions

- Provide fire extinguishing equipment and follow its instructions for use and hazard notes; see also section 2.6 on page 10.
- Switch off the laser unit, where the controller shall be incorporated.
Switch off the laser device, power supply, cooling and particularly disable moving parts.

Procedure



CAUTION

Heavy weight

Risk of injury

- Wear safety boots and work together with a second operator.

- Mount the controller on its place in the laser unit.

4.3.2. Connecting to the LAN or PC

Target audience and qualification

Experts

Procedure

- Connect the ASC through its Ethernet interface via a patch cable to the Local Area Network or PC.

Specification of the Ethernet interface

- Labeled: 0, 1
- Cable: type Cat-6; length max. 100 m
- Operating mode: 10BASE-T (Ethernet), 100BASE-T (Fast Ethernet) or 1000BASE-T (Gigabit Ethernet)

- Auto-MDI/MDIX-crossover for all operating modes
- Auto-negotiation according to IEEE 802.3u

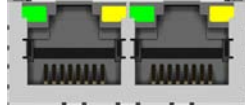

Connector type of the Ethernet interface: RJ45 socket

4.3.3. Alternatively to LAN: Connecting to WLAN

This functionality is an option and not necessarily part of your ASC.



Connector type of the WLAN interface: Hirose BNC HRM-200-066BP JBN socket

4.3.4. Connecting the data line to the scan head

Target audience and qualification

Experts

Procedure

- If you want to connect a scan head that is controlled via the ARGNET protocol, then connect the scan head data line according to the following specification to one of the $\odot 0$, $\odot 1$, $\odot 2$, $\odot 3$ connectors.

– OR –

If you want to connect a scan head that is controlled via the HSSI protocol, then connect the scan head data line according to the following specification to connector \square DATA A. Note that connector \square DATA B is non-functional.

Specification of the ARGNET interface

- Labeled: ① 0, ① 1, ① 2, ① 3
- Cable: type Cat-6; length max. 100 m
- Operating mode: 1000BASE-T in the ARGES-proprietary Gigabit Ethernet variant ARGNET
- Auto-MDI/MDIX-crossover for all operating modes
- Auto-negotiation according to IEEE 802.3u

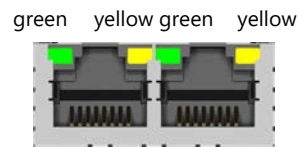

Connector type of the ARGNET interface: RJ45 socket

Specification of the DATA interface (HSSI)

- Labeled: □ DATA A (Note that connector □ DATA B is non-functional.)
- Cable: type Cat-5; length max. 25 m

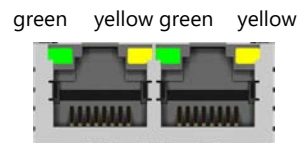

Connector type of the DATA interface: RJ45 socket

Further reading

Scan head instruction manual

4.3.5. Connecting the power supply to the scan head

4.3.5.1. Model ASC-1

Target audience and qualification

Experts

Requirements

- Scan head controlled via the ARGNET protocol.

NOTICE

Inappropriate specification of the power supply for scan heads controlled via the HSSI protocol will destroy the electronics of the scan heads.

- **Do not** connect a scan head that is controlled by the HSSI protocol to the ASC, but instead connect the scan head to a separate power supply.



Procedure

NOTICE

Voltage peaks and leakage currents, when hot plugging the power supply, destroy the scan head electronics.

- Before connecting the power supply to the scan head or disconnecting it from the scan head, ensure that no voltage is being applied to the connecting cable.
- Connect the scan head power supply according to the following specification to the scan head.

Specification of the scan head power supply

- Labeled:  POWER A,  POWER B
- Cable length typical 5 m

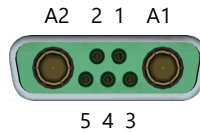

Connector type of the scan head power supply: (D-Sub) DA-7W2P

Table 4.4.: ASC-1: Pin assignment of the scan head power supply

Pin	Name	Description
A1	PWR	+48 V; max. 6.25 A
A2	GND	Ground
1	n.c.	Do not connect
2	PWR2	Default: 48V_SW 48 V; max. 1.5 A; Optional: VCC_S2 48 V, max. 7.5 A
3	n.c.	Do not connect
4	SH2_IF_HP_N	Scan head hot-plug, active low
5	GND2	Default: Ground; Optional: S2 voltage ground
S	GGND	Frame ground

Further reading

Scan head instruction manual

4.3.5.2. Models ASC-2 V41, ASC-6 V41

Target audience and qualification

Experts

Requirements

- Scan head controlled via the ARGNET protocol.

NOTICE

Inappropriate specification of the power supply for scan heads controlled via the HSSI protocol will destroy the electronics of the scan heads.

- **Do not** connect a scan head that is controlled by the HSSI protocol to the ASC, but instead connect the scan head to a separate power supply.



Procedure

NOTICE

Voltage peaks and leakage currents, when hot plugging the power supply, destroy the scan head electronics.

- Before connecting the power supply to the scan head or disconnecting it from the scan head, ensure that no voltage is being applied to the connecting cable.
- Connect the scan head power supply according to the following specification to the scan head.

Specification of the scan head power supply

- Labeled:  POWER A,  POWER B
- Cable length typical 5 m

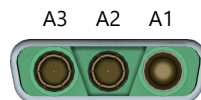

Connector type of the scan head power supply: (D-Sub) DA-3W3 3F3CS

Table 4.5.: ASC-2 V41: Pin assignment of the scan head power supply

Pin	Name	Description
A1	PWR	+48 V; max. 6.25 A ¹
A2	n. c.	Do not connect
A3	GND	Ground

Further reading

Scan head instruction manual

4.3.6. Connecting the laser fiber to the scan head

Target audience and qualification

Experts

Procedure

- This procedure is described in the instruction manual of the respective scan head.

Table 4.6.: ASC-6 V41: Laser parameter

Characteristic	Specification
Wavelength	1060–1070 nm
Average radiant power	150, 300 or 400 W (depending on model)
Pulse repetition frequency	continuous wave

4.3.7. Connecting the laser (omit this if a laser is incorporated)

Target audience and qualification

Experts

¹max. capacitive load 47,000 μ F; max. initial ohmic load 25 Ω

Procedure

- If a laser cable and laser adapter are enclosed with the delivery then connect the laser via the laser cable and the laser adapter. The respective instructions describe the laser adapter's interfaces.

– OR –

If a *Generic Laser Cable* is enclosed with the delivery then connect the laser according to the specification.

Specification of the laser interface

- Labeled: LASER
- Max. cable length: 10 m (5 m or less recommended; depending on the data transfer rate)

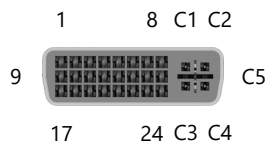

Connector type of the LASER interface: DVI-I dual link socket

Table 4.7.: Pin assignment of the LASER interface

Pin	Name	Description
1	RxD / Ra	Receive data signal input; 5 V level
2	CTS / Rb	Clear to send signal input – OR – Inverted receive data signal input; 5 V level
3	GND	Ground
4	TxD / Dy	Transmit data signal output; 5 V level
5	RTS / Dz	Ready for receiving signal output – OR – Inverted transmit data signal output; 5 V level
6	HSIO 0 ¹	High-speed signal input / output 0
7	HSIO 1 ¹	High-speed signal input / output 1
8	HSIO 2 ¹	High-speed signal input / output 2
9	Reserved	Do not connect

Pin	Name	Description
10	Reserved	Do not connect
11	GND	Ground
12	Reserved	Do not connect
13	Reserved	Do not connect
14	PWR	Power output; 5 V; max. 0.5 A
15	HSIO 3 ¹	High-speed signal input / output 3
16	HSIO 4 ¹	High-speed signal input / output 4
17	Reserved	Do not connect
18	Reserved	Do not connect
19	HP_N	Hot-plug detection input; 0 to 0.3 V: device is connected; 3 to 3.3 V device is not connected
20	Reserved	Do not connect
21	Reserved	Do not connect
22	HSIO 5 ¹	High-speed signal input / output 5
23	HSIO 6 ¹	High-speed signal input / output 6
24	HSIO 7 ¹	High-speed signal input / output 7
C1	DAC A ²	Analog signal output A
C2	DAC B ²	Analog signal output B
C3	DAC C ²	Analog signal output C
C4	DAC D ²	Analog signal output D
C5	AGND	Analog ground
S	GGND	Frame ground

Wiring examples

Novanta offers these laser adapters:

- Passive Generic Laser Adapter PGLA V2.0 B (order number 450-1015897-00)
- more on request

¹isolated, digital, slew rate controlled ports with individually programmable hardware delay lines and a time resolution of 10 ns; 5 V (24 V tolerant); outputs max. 25 mA; terminate inputs with 2.2 k Ω ; the InScript software can map signals to HSIOs in the respective device drivers

²for simultaneous analog modulation with active drift compensation; 16 bit resolution plus 1/64 LSB gain and 1/256 LSB offset correction; 100 kHz sampling rate; ± 10 V; max. 10 mA; signals can be mapped to the DACs via the InScript software

A laser can be eventually controlled without using an adapter, if it can be connected via the *Generic Laser Cable*. This cable provides the signals HSIO 0 to 2 and DAC A to B on 5 BNC connectors, see table 4.8:

- Generic Laser Cable, length: 5 m (order number 419-1008175-00)
- Generic Laser Cable, length: 10 m (order number 419-1013404-00)

Table 4.8.: Assignment of the Generic Laser Cable's BNC connectors to signals when connected to the LASER interface

Pin	Name	Description
● Blue	HSIO 0	First-Pulse-Kill signal (factory setting)
● Green	HSIO 1	Auxilliary signal (factory setting)
● Red	HSIO 2	Gate signal (factory setting)
● Black	DAC A	Analog signal A
● Gray	DAC B	Analog signal B

Further reading

- Instructions for installation of your laser adapter
- *InScript Firmware – User Manual* [2], chapter *Devices: Laser*

Find tailored device drivers for some lasers in this chapter. The InScript software can control most of the other lasers via the *configurable laser* device driver.

The InScript software refers to the RS-232 interface at the LASER connector as *COM C*.

4.3.8. Connecting safety relevant devices to the ASC-6 V41

This functionality is an option and not necessarily part of your ASC.

Target audience and qualification

Experts

Procedure

- Connect the safety relevant devices according to the following specification.

Specification of the "safety" connector

- Labeled: –
- Cable length: typ. 5 m



Connector type of the "safety" connector: 12 pin socket HARTING HAN DD module 09 14 012 3101 with housing 09 14 001 0301

Table 4.9.: ASC-6 V41: Pin assignment of the "safety" connector

Pin	Name	Description
1	EM_EXT_LED	Output signal "SFT (safety) board ready"; 24 V; max. 20 mA
		Connect an emergency stop switch with:
2	EM_NCC_2	Normally closed contact; pin 2
3	EM_NCC_1	Normally closed contact; pin 1
4	EM_NOC_2	Normally opened contact; pin 2
5	EM_NOC_1	Normally opened contact; pin 1
6	GND	Ground

Pin	Name	Description
7	PWR_OUT	Output; 24 V; max. 2 A
8	IL_NCC_2	Connect an interlock with: Normally closed contact; pin 2
9	IL_NCC_1	Normally closed contact; pin 1
10	LASER_ON_LED	Output signal "laser on"; 5 V; max. 50 mA
11	REM_START_N	Input signal "remote start"; brings the SFT (safety) board back to ready state after a non-auto-recoverable event; 24 V; max. 10 mA; switches at 3 mA raising edge; negative pin
12	REM_START_P	Positive pin to pin 11
S	GGND	Frame ground

4.3.9. Optionally connecting a programmable logic controller

Target audience and qualification

Experts

Procedure

- Optionally connect a programmable logic controller according to the following specification.

TIP

For correct operation of the digital in- and outputs connect PWR_IN (pin 1) and GND (pin 10) at the PLC interface.
If you are additionally using the PLC AUX interface then connect PWR_IN (pin 1) at the PLC AUX interface in addition.

Specification of programmable logic controller interface

- Labeled: PLC, PLC AUX
- Max. cable length: 25 m

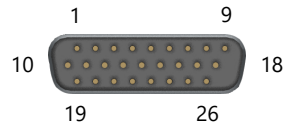

Connector type of the PLC interface: (D-Sub) DA-26P

Table 4.10.: Pin assignment of the PLC interface

Pin	Name	Description
1	PWR_IN	Voltage input that provides the voltage for the digital outputs; 24 V nom.; 12 bis 36 V tol.; 1 A max.
2	JOB_START_IN	Digital input: 24 V nom. (12 to 36 V); active edge: raising
3	Reserved	Do not connect
4	Reserved	Do not connect
5	JOB_ABORT_IN	Digital input: 24 V nom. (12 to 36 V); active edge: raising
6	Reserved	Do not connect
7	SAFE_REQUEST_IN	Digital input: 24 V nom. (12 to 36 V); active level: high
8	ATTENTION_IN	Digital input: 24 V nom. (12 to 36 V); active level: high
9	Reserved	Do not connect
10	GND	Ground

Pin	Name	Description
		<i>Digital outputs:</i> galvanically isolated, short circuit proof with integrated flyback circuit, high-side driver, output current source max. 150 mA continuous (500 mA peak), sink not specified
11	JOB_READY_OUT	Digital output; voltage depends on pin 1; active level: high
12	JOB_ACTIVE_OUT	Digital output; voltage depends on pin 1; active level: high
13	Reserved	Do not connect
14	Reserved	Do not connect
15	JOB_FAILED_OUT	Digital output; voltage depends on pin 1; active level: high
16	JOB_COMPLETED_OUT	Digital output; voltage depends on pin 1; active level: high
17	Reserved	Do not connect
18	DEVICES_SAFE_OUT	Digital output; voltage depends on pin 1; active level: high
19	Reserved	Do not connect
20	Reserved	Do not connect
21	DEVICES_READY_OUT	Digital output; voltage depends on pin 1; active level: high
22	DEVICES_AWAKE_OUT	Digital output; voltage depends on pin 1; active level: high
23	DEVICES_FAILURE_OUT	Digital output; voltage depends on pin 1; active level: high
24	Reserved	Do not connect
25	Reserved	Do not connect
26	Reserved	Do not connect
S	GGND	Frame ground

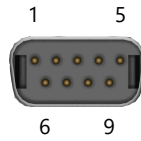

Connector type of the PLC AUX interface: (D-Sub) DE-9P

Table 4.11.: Pin assignment of the PLC AUX interface

Pin	Name	Description
1	PWR_IN	Voltage input that provides the voltage for the digital outputs; 15 V nom.; 12 bis 36 V tol.; 3 A max.
		<i>Digital inputs:</i> galvanically isolated; sampling frequency 100 kHz; low < 66 % and high > 82 % (e. g. signal threshold at 15 V: low = 9.90 V and high = 12.30 V)
2	Reserved	Do not connect
3	Reserved	Do not connect
4	Reserved	Do not connect
5	Reserved	Do not connect
		<i>Digital outputs:</i> galvanically isolated, short circuit proof with integrated flyback circuit, high-side driver, output current source max. 150 mA continuous (500 mA peak), sink not specified
6	Reserved	Do not connect
7	Reserved	Do not connect
8	Reserved	Do not connect
9	Reserved	Do not connect
S	GGND	Frame ground

Signal description

JOB_START_IN starts the job and continues the job respectively, if the job is paused

JOB_ABORT_IN aborts the job immediately and activates the JOB_FAILED_OUT signal

SAFE_REQUEST_IN tries to set all managed devices to the power state *Armed*. With a laser device, this is the state where the GATE signal and the MOD signal are deactivated.

ATTENTION_IN tries to set all managed devices to the power state *Ready* and keeps them in this state even if e. g. a power saver is active

JOB_READY_OUT indicates the job is selected and ready for the JOB_START_IN signal

JOB_ACTIVE_OUT indicates that the job is active

JOB_FAILED_OUT indicates that the job failed either because of a JOB_ABORT_IN signal or another event

JOB_COMPLETED_OUT indicates that the job has been successfully completed

DEVICES_SAFE_OUT indicates that all managed devices are in the power state *Armed*

DEVICES_READY_OUT indicates that all managed devices are in the power state *Ready* and in the error state *OK*

DEVICES_AWAKE_OUT if the ATTENTION_IN signal is active or if a job is running then this signal indicates that all managed devices are in the power state *Ready* regardless of the error state

DEVICES_FAILURE_OUT indicates that at least one managed device is in error state *Failure*

Wiring examples

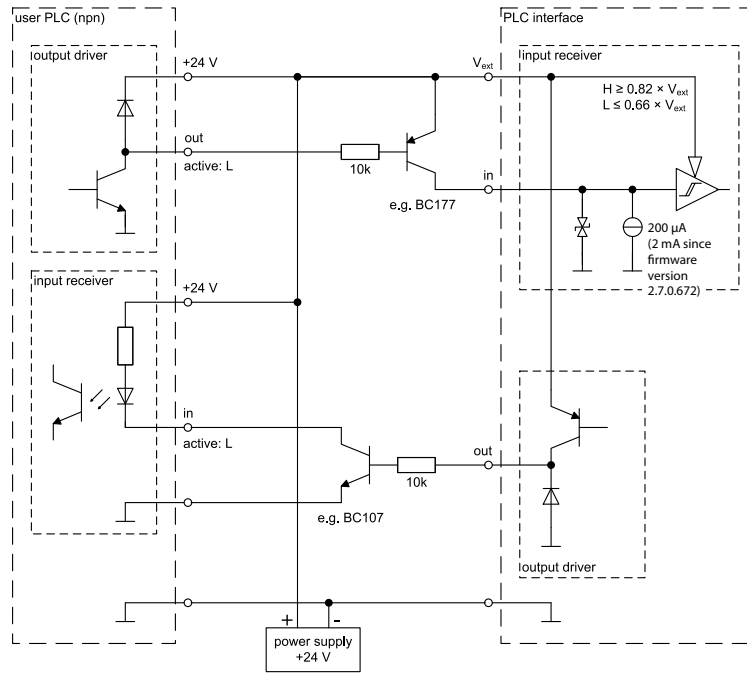

Figure 4.4.: Connecting a npn-PLC to the PLC and PLC AUX connector

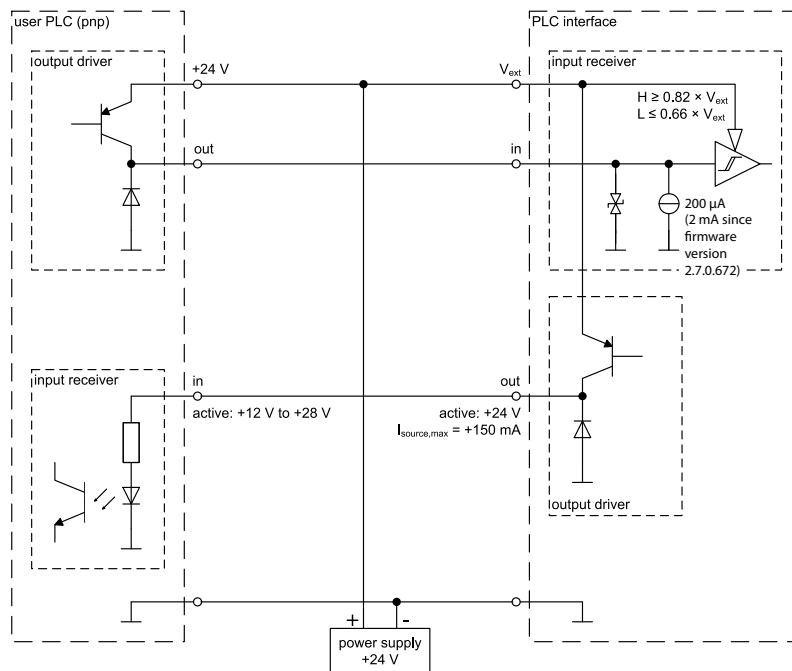

Figure 4.5.: Connecting a pnp-PLC to the PLC and PLC AUX connector

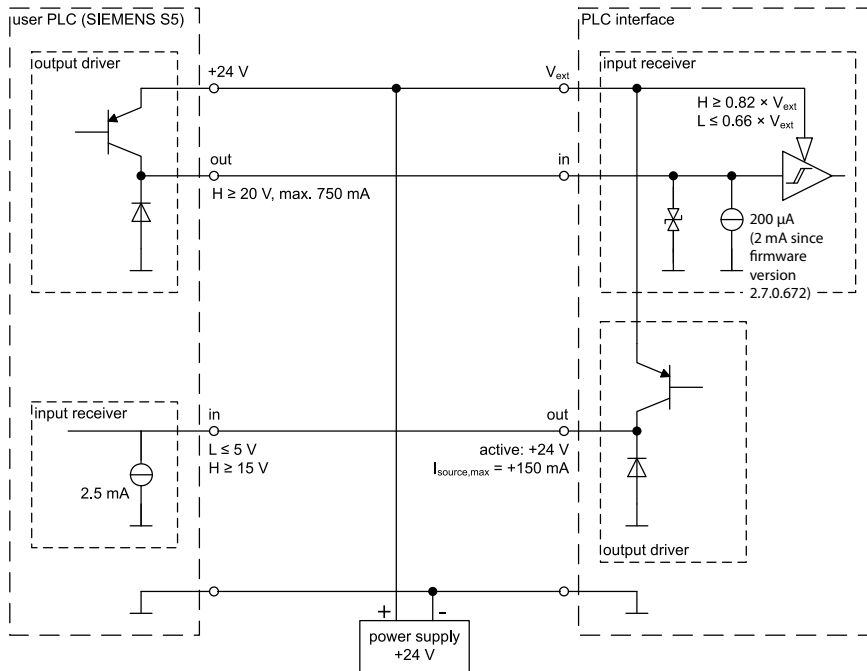

Figure 4.6.: Connecting a SIEMENS S5 PLC to the PLC and PLC AUX connector

Further reading

InScript Firmware – User Manual [2], see the *Devices* chapters

4.3.10. Optionally connecting position encoders

Target audience and qualification

Experts

Procedure

- Optionally connect the position encoder according to the following specification to interface $\langle 0 \rangle$.

Interfaces $\langle 1 \rangle$ and $\langle 2 \rangle$ are not operational and intended for future applications.

Specification of the position encoder interface

- Labeled: $\langle\bar{0}\rangle$, $\langle\bar{1}\rangle$, $\langle\bar{2}\rangle$
- Max. cable length: 10 m
- for incremental position encoder
 - OR –
 - on request, for position encoder with synchronous serial interface (SSI)
- Differential line drivers and receivers
- Max. signal frequency: 30 MHz

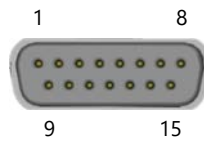

Connector type of the position encoder interface: (D-sub) DA-15P

Table 4.12.: Pin assignment of the position encoder interface

Pin	Name	Description
1	PWR_OUT	Power output, 5 V, max. 0.5 A
2	GND	Ground
3	A_P_IN	Input for positive square-wave signal train A; 0 to 3.3 V; TTL; 5 V tolerant
4	A_N_IN	Input for negative square-wave signal train A; see pin 3
5	DATA_P_IN	Input for positive MOSI/MISO signal; 0 to 3.3 V; TTL; 5 V tolerant
6	B_P_IN	Input for positive square-wave signal train B; 0 to 3.3 V; TTL; 5 V tolerant
7	B_N_IN	Input for negative square-wave signal train B; see pin 6
8	DATA_N_IN	Input for negative MOSI/MISO signal; see pin 5
9	n.c.	Do not connect
10	I_P_IN	Input for positive reference pulse I; 0 to 3.3 V; TTL; 5 V tolerant
11	HP_IN	Input for hot plug-in signal from position encoder; low = connected

Pin	Name	Description
12	I_N_IN	Input for negative reference pulse I; see pin 10
13	GGND	Frame ground
14	CLOCK_P_OUT	Output for positive clock signal; 0 to 3.3 V; TTL
15	CLOCK_N_OUT	Output for negative clock signal; see pin 14
S	GGND	Frame ground

Further reading

InScript Firmware – User Manual [2], see the *Devices* chapters

4.3.11. Optionally connecting a serial or CAN device

You may want to connect devices to the IOIOI interface that communicate with the ASC via RS-232, RS-485 or CAN open.

Target audience and qualification

Experts

Procedure

- Optionally connect a device that communicates with the ASC via RS-232, RS-485 or CAN open to the IOIOI interface according to the following specification.

Specification of the position encoder interface

- Labeled: IOIOI
- You can use the IOIOI interface alternatively as RS-232 or RS-485 interface with an additional CANopen interface in each case.

TIP

Use the gender changer adapter provided by Novanta (item no.450-1008258-00). This adapter prevents problems that may occur when using a cable where all lines are connected through and the connected device is providing additional signals or voltage at pins 1, 4, 6 and/or 9.

- Max. cable length for RS-232: 10 m, for RS-485: 25 m and for CAN at 1 MBit/s: 25 m

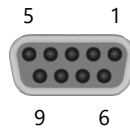

Connector type of the IOIOI interface: (D-Sub) DE-9S

Table 4.13.: Pin assignment of the IOIOI interface when used as RS-232/CAN interface

Pin	Name	Description
1	CANL	Differential CAN low signal, 3.3 V level
2	RxD	Receive data signal, 3.3 V level
3	TxD	Transmit data signal, 3.3 V level
4	GND_ISO	Isolated ground
5	GND_ISO	Isolated ground
6	CANH	Differential CAN high signal, 3.3 V level
7	RTS	Ready for receiving, 3.3 V level
8	CTS	Clear to send, 3.3 V level
9	n.c.	Reserved
S	Shield	Shield

– OR –

Table 4.14.: Pin assignment of the IOIOI interface when used as RS-485/CAN interface

Pin	Name	Description
1	CANL	Differential CAN low signal, 3.3 V level
2	Ra	Receive data signal, 3.3 V level

Pin	Name	Description
3	Dy	Transmit data signal, 3.3 V level
4	GND_ISO	Isolated ground
5	GND_ISO	Isolated ground
6	CANH	Differential CAN high signal, 3.3 V level
7	Dz	Inverted transmit data signal, 3.3 V level
8	Rb	Inverted receive data signal, 3.3 V level
9	n. c.	Reserved
S	Shield	Shield

Further reading

InScript Firmware – User Manual [2], see the *Devices* chapters. The InScript software refers to the serial interface as *COM B*.

4.3.12. Optionally connecting EtherCAT devices

EtherCAT® is a registered trademark and patented technology, licensed by Beckhoff Automation GmbH, Germany.

This functionality is an option and not necessarily part of your ASC.

If you want to read out measurement data and send configuration data via EtherCAT then connect the EtherCAT devices to these interfaces.

Alternatively you may want read out measurement data and send configuration data to the ASC by a PC. In this case use the Ethernet interface; see section 4.3.2 on page 32.

Target audience and qualification

Experts

Procedure

- Optionally connect EtherCAT devices according to the following specification.

Specification of the EtherCAT interface

TIP

The ASC has several interfaces in the form of RJ45 sockets. When connecting the cables pay attention to the labeling on the housing.

- Labeled: ETHERCAT
- The ASC is a EtherCAT slave device
- Max. cable length: 100 m

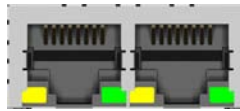

Connector type of the ETHERCAT interface: RJ45 socket

Table 4.15.: Pin assignment of the ETHERCAT interface

Pin	Name	Description
1	TxD_P	Transmit, positive, 3.3 V level
2	TxD_N	Transmit, negative, 3.3 V level
3	RxD_P	Receive, positive, 3.3 V level
4	RxD_N	Receive, negative, 3.3 V level
5	n. c.	Do not connect
6	n. c.	Do not connect
7	n. c.	Do not connect
8	n. c.	Do not connect
S	GGND	Frame ground

Further reading

InScript Firmware – User Manual [2], see the *Devices* chapters

4.3.13. Optionally connecting a PROFIBUS master device

This functionality is an option and not necessarily part of your ASC.

Target audience and qualification

Experts

Procedure

- Optionally connect the ASC as PROFIBUS slave device according to the following specification.

Specification of the PROFIBUS interface

- Labeled: PROFIBUS
- The ASC is a PROFIBUS slave device

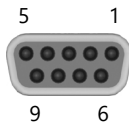

Connector type of the PROFIBUS interface: (D-sub) DE-9S socket

Table 4.16.: Pin assignment of the PROFIBUS interface

Pin	Name	Description
1	n. c.	Do not connect
2	n. c.	Do not connect
3	B-line	Line B
4	RTS	Request to send signal
5	GND BUS	Isolated
6	+5V BUS	Output, isolated, max. 100 mA
7	n. c.	Do not connect
8	A-line	Line A
9	n. c.	Do not connect
S1	Shield	Shield
S2	Shield	Shield

Further reading

InScript Firmware – User Manual [2], see the *Devices* chapters

4.3.14. Optionally connecting other devices to the GENERAL PURPOSE I/O interface**Target audience and qualification**

Experts

Procedure

- Optionally connect a device to the GENERAL PURPOSE I/O according to the following specification.

Specification of the GENERAL PURPOSE I/O interface

- Labeled: GENERAL PURPOSE I/O
- Max. cable length: 2.5 m

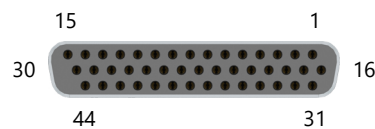

Connector type of the GENERAL PURPOSE I/O interface: (D-sub) DB-44SP

Table 4.17.: Pin assignment of the GPIO interface

Pin	Name	Description
		<i>Digital inputs:</i> 24 V tolerant; galvanically isolated; sampling frequency up to 100 MHz; the InScript software can map signals to digital inputs in the respective device drivers
1	IN_1	Digital input 1
2	IN_2	Digital input 2
3	IN_3	Digital input 3

Pin	Name	Description
4	IN_4	Digital input 4
5	IN_5	Digital input 5
6	IN_6	Digital input 6
7	IN_7	Digital input 7
8	IN_8	Digital input 8
9	IN_9	Digital input 9
10	IN_10	Digital input 10
11	IN_11	Digital input 11
12	IN_12	Digital input 12
13	IN_13	Digital input 13
14	IN_14	Digital input 14
15	IN_15	Digital input 15
16	IN_0	Digital input 0
<p><i>Digital inputs:</i> The InScript software can map signals to digital inputs in the respective device drivers</p>		
17	OUT_2	Digital output 2; voltage depends on pin 41
18	OUT_3	Digital output 3; voltage depends on pin 41
19	OUT_4	Digital output 4; voltage depends on pin 42
20	OUT_5	Digital output 5; voltage depends on pin 42
21	OUT_6	Digital output 6; voltage depends on pin 42
22	OUT_7	Digital output 7; voltage depends on pin 42
23	OUT_8	Digital output 8; voltage depends on pin 43
24	OUT_9	Digital output 9; voltage depends on pin 43
25	OUT_10	Digital output 10; voltage depends on pin 43
26	OUT_11	Digital output 11; voltage depends on pin 43
27	OUT_12	Digital output 12; voltage depends on pin 44
28	OUT_13	Digital output 13; voltage depends on pin 44
29	OUT_14	Digital output 14; voltage depends on pin 44
30	OUT_15	Digital output 15; voltage depends on pin 44
31	OUT_1	Digital output 1; voltage depends on pin 41
32	OUT_0	Digital output 0; voltage depends on pin 41
<p>Pins 33 through 36 are internally connected</p>		
33	GND	Ground

Pin	Name	Description
34	GND	Ground
35	GND	Ground
36	GND	Ground
Pins 37 and 38 are internally connected		
37	PWR_OUT_0	Power output 0; 5 V; 0.5 A
38	PWR_OUT_0	Power output 0; 5 V; 0.5 A
Pins 39 and 40 are internally connected		
39	PWR_OUT_1	Power output 1; 5 V; 1 A
40	PWR_OUT_1	Power output 1; 5 V; 1 A
41	PWR_IN_0	Power input 0 that provides the voltage for the digital outputs OUT0 (pin 32), 1 (pin 31), 2 (pin 17) and 3 (pin 18); 5 to 24 V nom. (30 V max.)
42	PWR_IN_1	Power input 1 that provides the voltage for the digital outputs OUT4 (pin 19), 5 (pin 20), 6 (pin 21) and 7 (pin 22); 5 to 24 V nom. (30 V max.)
43	PWR_IN_2	Power input 2 that provides the voltage for the digital outputs OUT8 (pin 23), 9 (pin 24), 10 (pin 25) and 11 (pin 26); 5 to 24 V nom. (30 V max.)
44	PWR_IN_3	Power input 3 that provides the voltage for the digital outputs OUT12 (pin 27), 13 (pin 28), 14 (pin 29) and 15 (pin 30); 5 to 24 V nom. (30 V max.)
S	GGND	Frame ground

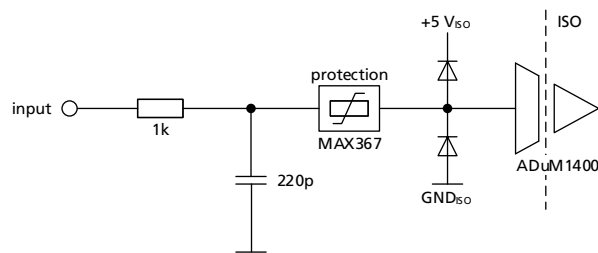

Figure 4.7.: GPIO interface: Circuit diagram excerpt at input side

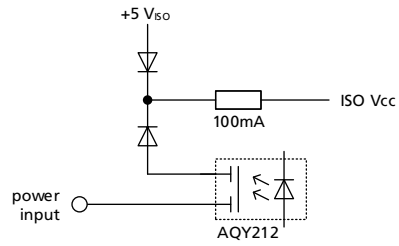

Figure 4.8.: GPIO interface: Circuit diagram excerpt for output voltage switching

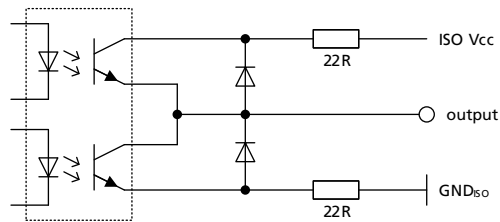

Figure 4.9.: GPIO interface: Circuit diagram excerpt at output side

Further reading

InScript Firmware – User Manual [2], see the *Devices* chapters

4.3.15. Optionally connecting USB 3.1 devices

Target audience and qualification

Experts

Procedure

- Do not connect USB devices.

This interface is not operational and intended for future applications.

Specification of the USB 3.1 interface

- Labeled: [not labeled]



Connector type of the USB 3.1 interface: USB Type C socket

4.3.16. Optionally connecting USB 2.0 devices

Target audience and qualification

Experts

Procedure

- Do not connect USB devices.

This interface is not operational and intended for future applications.

Specification of the USB 2.0 interface

- Labeled: 



Connector type of the USB 2.0 interface: USB Type A socket

4.3.17. Optionally connecting the internal laser to the Ethernet

This functionality is an option and not necessarily part of your ASC.

This interface is reserved for service purposes. Please consult the instruction manual of the respective laser.

Target audience and qualification

Experts

Procedure

- Connect the ASC's internal laser through its ETHERNET LASER interface via a patch cable to the Local Area Network or PC.

Specification of the Ethernet interface

- Labeled: ETHERNET LASER
- Please consult the instruction manual of the respective laser for further information.

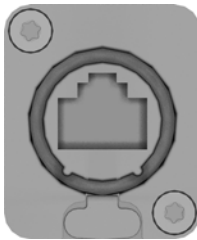

Connector type of the ETHERNET LASER interface: NE8FDX-P6 socket (RJ45)

4.3.18. Connecting mains supply

4.3.18.1. Models ASC-1, ASC-2 V41

Target audience and qualification

Experts

Requirements

Table 4.18.: ASC-1, ASC-2 V41: Mains supply

Characteristic	Specification
Model ASC-1	
Voltage; frequency	90–250 V; 47–63 Hz
Power consumption at 230 V	Max. 600 W; Peak 900 W (< 5 s, 50 % duty cycle)
Input current	7 A @ 600 W; 10.6 A @ 900 W;

Characteristic	Specification
	Fast acting fuse @ 8 A
Model ASC-2 V41	
Voltage; frequency	90–264 V; 47–63 Hz
Power consumption at 230 V	Max. 600 W; Peak 900 W (< 5 s, 50 % duty cycle)
Input current	2.6 A @ 600 W; 3.9 A @ 900 W

Procedure

1. Ground the frame by the M5 thread insert that can be found next to the mains supply connector. The grounding thread insert is labeled by \perp .
2. Connect the ASC according to the specification via its mains supply connector to the mains supply.

The ASC will boot as soon as it is connected to mains supply.

Specification of the mains supply connector

- Labeled: –
- Cable type: C13 power cord

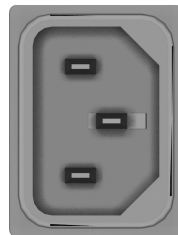

ASC-1, ASC-2 V41: Connector type of the mains supply connector: C14 panel plug with 3 pins

4.3.18.2. Model ASC-6 V41**Target audience and qualification**

Experts

Requirements

Table 4.19.: ASC-6 V41: Mains supply

Characteristic	Specification
Voltage; frequency	90–264 V; 47–63 Hz
Power consumption at 230 V	Max. 2616 W; Peak 3420 W
Input current	11.4 A @ 2616 W; 14.9 A @ 3420 W

Procedure

1. Ground the frame by the M5 bolt that can be found next to the mains supply connector. The grounding bolt is labeled by \perp .
2. Connect the ASC according to the specification via its mains supply connector to the mains supply.

The ASC will boot as soon as it is connected to mains supply.

Specification of the mains supply connector

- Labeled: –
- Cable length: typ. 5 m
- Cable cross section: 2.5 to 8 mm²

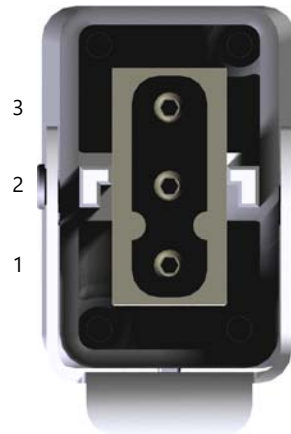

ASC-6 V41: Connector type of the mains supply connector: 3 pin plug HARTING HAN C module 09 14 003 2601 with housing 09 14 001 0301

Table 4.20.: ASC-6 V41: Pin assignment of the mains supply connector

Pin	Name	Description
1	L	Phase
2	PE	Protective earth
3	N	Neutral
S	GGND	Frame ground

4.3.19. Remote On/Off

You can switch on and off the ASC remotely via this interface.

Target audience and qualification

Experts

Procedure

- Optionally connect the product according to the following specification.

Specification of the Remote On/Off interface

- Labeled: ⏻ REMOTE

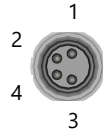

Connector type of the Remote On/Off interface: Amphenol M8S-04PFFP-SF8001 socket

Table 4.21.: Pin assignment of the Remote On/Off interface

Pin	Name	Description
1	B2B_SPS_REMOTE_ON	Switch on: close pins 1 and 2 Switch off: open pins 1 and 2 Power input 3.3 V
2	GND	Ground
3	PWR_REMOTE_5V_0A1_08	While <i>on</i> pins 3 and 4 are internally closed via an optocoupler Power output 5 V
4	B2B_SPS_REMOTE_RUN_N	

4.4. Commissioning

4.4.1. Changing the network settings

This procedure is necessary in order to connect the InScript software with the ASC later on.

Target audience and qualification

Experts

Requirements

- The ASC is installed and connected to your devices as described in section 4.3 on page 27.
- The laser unit complies with the standards that are required by the declaration of incorporation of each component.

Procedure

1. Check with your network administrator if the factory settings can be used within your Local Area Network or PC. The factory settings are:

IP-address 192.168.1.42
 subnet mask 255.255.255.0

2. Check with your network administrator that exceptions are made at ports 80, 1610, 1611 and 1612 in all active firewall and security software to ensure access to the ASC.
3. If the factory settings can be used then the ASC is connected to your Local Area Network or PC now and the procedure ends here then.

– OR –

If the factory settings *can not* be used then

- a) Request an IP-address and a subnet mask for the ASC from your network administrator and note them down here.

IP-address |___|·|___|·|___|·|___|

Subnet mask |___|·|___|·|___|·|___|

- b) At the ASC front panel, turn the key to horizontal position.
- c) Press (hard) the standby/on push-button (ARGES head).

The blue light starts an upward motion indicating that the system is starting. Once the system is startup sequence is completed the push-button is illuminated steadily and the right display indicates that the system is ready.

- d) Set the IP-address and the subnet mask via the ASC's right front display (for usage see section 5.4.2 on page 69).

- e) Press (hard) and hold the standby/on push-button (ARGES head) for at least 2 seconds.

The blue light at the push-button starts a downwards motion and the display shows *Preparing power off*. The system is down, when only one LED at the push-button is blinking. This indicates the ASC is in standby now.

The ASC is connected to your Local Area Network or PC now.

4.4.2. Completing the commissioning via the InScript software

Target audience and qualification

Experts

Requirements

- The ASC is connected to the local network area or to a PC as described in section 4.4.1 on page 65.

Procedure

- In order to complete the commissioning with the InScript Software you have to install and start the InScript software at first.

Then follow the instructions in *InScript Software – User Manual* [3] in chapters *Installing*, *Starting* and *Commissioning*.

5. Operating

5.1. Protection of persons

The ASC is incorporated in a laser unit and integrated into its concept for the protection of persons.

5.2. Emergency measures

The ASC is incorporated in a laser unit and integrated into its emergency stop circuit. The emergency measures are based upon this laser unit.

5.3. Observable signals

[to be defined]

Find the description of LED-states in section 5.5 on page 71.

5.4. Operational procedures

5.4.1. Starting up

Target audience and qualification

Operators and experts

Requirements

- Peripheral devices that are connected to the ASC are ready.

Procedure

1. If you have connected a scan head that is controlled via the HSSI protocol and is powered by a separate power supply, turn on that scan head and wait 10 seconds.
2. At the ASC's front panel turn the key into horizontal position.
3. Press (hard) the standby/on pushbutton (ARGES head).

The blue light starts an upward motion indicating that the system is starting. Once the startup sequence is completed the pushbutton is steadily illuminated and the right display indicates that the system is ready.

Now you can connect the InScript software, see [3], chapter *Managing Controllers*, or the ControllerLib, see [1], to the ASC or operate the ASC via its display and joystick at its front, see section 5.4.2.

5.4.2. Operating

Via display and joystick you can execute the following actions.

TIP

Usually control the ASC via the InScript software [3] or via the ControllerLib [1].

- Load a job, select a job for execution, execute a job, and abort the execution of a job
- Show the system state
- Start, halt and stop respectively, and restart the controller, firmware, and Render Server
- Edit the network settings
- Edit the system date and time
- Edit the display settings and calibrate the touchscreen

Target audience and qualification

Operators and experts

Procedure

- Control the right front display like a touch-screen.

– OR –

Control the right front display by the joystick next to it:

1. Set the focus to the desired control.

The focus is symbolized by a fine rectangle around the control.

To move the focus from control to control, use the joystick like a rotary knob.

2. Select one of the following actions:

To click a button  , push the joystick like a push-button

To select an entry from a drop down list  ,

- a) Push the joystick like a push-button to enter the drop down list.
- b) Move the joystick up or down to set the focus on a list entry.
- c) Push the joystick like a push-button to select the list entry and close the drop down list.

To increase or decrease a value in a spin box  , move the joystick up or down

To move a slide control  , move the joystick left or right

5.4.3. Shutting down

Target audience and qualification

Operators and experts

Procedure

1. If instances of the InScript software or ControllerLib are connected to the ASC then exit these instances.
2. Press (hard) and hold the standby/on pushbutton (ARGES head) for at least 2 seconds.

– OR –

On the display on page *Maintenance* in line *Controller*, click **Halt**; see also section 5.4.2 on page 69.

The blue light at the pushbutton starts a downwards motion and the display shows the message *Preparing power off*. All peripheral devices with active device drivers will be shut down.

The system is down, when only one LED in the pushbutton is blinking (standby).

3. Wait until the system is shut down completely. Turning the key switch prematurely has no effect.
4. Turn the key to vertical position.
5. Remove the key from the key switch.

That way the ASC cannot be started by unauthorized personnel.

5.5. Troubleshooting

Target audience and qualification

Operators and experts

Procedure

- In the *InScript* software notice window *Messages*. There find error messages at issue listing the symptom (= *Caption*) including the potential root causes (= *Cause*) and measures to fix the respective error (= *Remedy*).

Additionally use table 5.1.

Additionally use the LEDs at the ASC's aft. The locations of these LEDs are shown in sections 3.2.3 ff. Find the meaning of these LEDs in tables 5.2 ff.

Table 5.1.: Troubleshooting

Symptom	Potential root cause	Measure
Wrong time and date	Time and date not set	Set time and date via display and joystick; see subsection 5.4.2
	Flat battery	Replace battery; for the ASC-1 see section 6.2.2; for the ASC-2 V41, ASC-6 V41 see section 6.2.2
[to be defined]	[to be defined]	Clean fiber tips; see section 6.4
[to be defined]	[to be defined]	Replace fiber; see chapters 7 and 4
[to be defined]	[to be defined]	Contact Novanta support; see page 2

Table 5.2.: Meaning of the ARGES-head button LEDs

Position	State	Meaning
Head	○ Off	Power switched off
	● Blue, pulsating	Controller in standby mode
	● Blue, upwards running light	Controller is booting up
	● Blue, downwards running light	Controller is shutting down
	● Blue	Controller is ready
Beam	○ Off	No job is selected
	● Yellow	Job is selected
	● Yellow, flashing	Job is being executed

Table 5.3.: Meaning of the 3 LEDs at the front side's center

Position	State	Meaning
Left	○ Off	[to be defined]
Middle	○ Off	[to be defined]
Right	○ Off	[to be defined]

Table 5.4.: Meaning of the LED-group PLE (Programmable Logic controller and Encoder)

Position	State	Meaning
Top	○ Off	Assigned to the PLC/PLC AUX interface No signal
	● Red	Job abort
	● Green, flashing	Job start
Center	○ Off	Assigned to the encoder interface '0' No signal
	● Red	Fault
	● Blue, flashing	Trigger signal
	● Green	Encoder connected
	● Green, flashing	Counting pulses
Bottom	○ Off	Assigned to the encoder interface '1' No signal
	● Red	Error
	● Blue, flashing	Trigger signal
	● Green	Encoder connected
	● Green, flashing	Counting pulses

Table 5.5.: Meaning of the LED-group GPU (General Purpose Unit)

Position	State	Meaning
Top		Assigned to [to be defined]
Center		Assigned to [to be defined]

Position	State	Meaning
Bottom		Assigned to [to be defined]



Table 5.6.: Meaning of the LEDs at the ARGNET interface

Position	State	Meaning
Left	○ Off	No network link
	● Green	Network link
Right	○ Off	No network activity
	● Yellow	Network activity

Table 5.7.: Meaning of the LEDs at the DATA interface

Position	State	Meaning
Left	○ Off	[to be defined]
	● Green	[to be defined]
Right	○ Off	[to be defined]
	● Yellow	[to be defined]

Table 5.8.: Meaning of the LED-group PWR (PoWeR)

Position	State	Meaning
Top		Assigned to scan head  A
	○ Off	Scan head not detected
	● Green	Power OK
	● Red	Power not OK
Center		Assigned to scan head  B
	○ Off	Scan head not detected
	● Green	Power OK
	● Red	Power not OK
Bottom		Assigned to the ASC_MCB600_CTR FPGA

Position	State	Meaning
	○ Off	FPGA not OK
	● Green, flashing	FPGA OK (FPGA heartbeat)
	● Red, flashing	FPGA OK, but BIOS bit configuration ERROR detected

Table 5.9.: Meaning of the LEDs at the Ethernet interface

Position	State	Meaning
Left	○ Off	No network link
	● Green	Network link
Right	○ Off	No network activity
	● Yellow, flashing	Network activity

Table 5.10.: Meaning of the LEDs at the EtherCAT interfaces

Position	State	Meaning
Left	○ Off	Not implemented
Right	○ Off	No link
	● Green	Link established but without activity
	● Green, flashing	Link and activity

Table 5.11.: Meaning of LED-group EC below the EtherCAT interface

Position	State	Meaning
Left	● Green	Run
Right	● Red	Error

Table 5.12.: Meaning of the LED-group SYS (SYStem) while booting (Bootling progresses from top to bottom.)

Position	State	Meaning
Top	○ White, flashing briefly	Power switched on
Center	○ White, flashing briefly	
Bottom	○ White, flashing briefly	
Top	○ Off	Boot loader starting up
Center	● Yellow	
Bottom	● Yellow	
		Boot loader configuration
Top	○ Off	Bootling up starts
Center	● Yellow	
Bottom	○ Off	
		Kernel loading to memory
Top	○ Off	Kernel boots up and takes control
Center	● Red	
Bottom	○ Off	
		Bootling up kernel and mounting root file system
Top	● Red	Executing first start script
Center	○ Off	
Bottom	○ Off	
		Executing start scripts and bootling system
Top	● Green	Executing last start script
Center	○ Off	
Bottom	○ Off	
		System ready

Table 5.13.: Meaning of the LED-group SYS (SYStem) while halting (Halting progresses from top to bottom.)

Position	State	Meaning
Top	● Red	Initiating shutdown
Center	○ Off	
Bottom	○ Off	
Executing stop skripts		
Top	○ Off	Ready for switching off
Center	○ Off	
Bottom	○ Off	

6. Cleaning, maintaining and repairing

Cleaning, maintaining and repairing are limited to the procedures described in this chapter. If other measures become necessary then contact our customer support; see page ii.

6.1. Maintenance plan

We recommend to create a maintenance plan. The maintenance intervals depend on the degree of contamination at the work environment.

Table 6.1.: Maintenance plan

Interval	Measure	See section	On page
As necessary	Replace the air filters for model ASC-1	6.2.1	79
	Replacing the air filters for models ASC-2 V41, ASC-6 V41	6.3.1	82
Annually	Check the laser unit and the incorporated controller according to standard EN 60204. Check the electrical safety of all connecting cables and particularly the mains cable.	–	–
Every 2 years	Replace the battery for model ASC-1	6.2.2	80
	Replacing the battery for model for models ASC-2 V41, ASC-6 V41	6.3.2	83

6.2. Model ASC-1

6.2.1. Replacing the air filters

Target audience and qualification

Experts

Have ready

- Air filters; see table A.1 on page 90
- Flat-bladed screwdriver; width max. 5 mm

Procedure

TIP

In general the device is incorporated into a 19-inch rack. The air filters can be accessed via the device's sides. For this purpose the connections at the device's rear have to be disconnected eventually and the device has to be pulled out from the 19-inch rack.

NOTICE

Insufficient ventilation

Overheating can result in function loss

- (Reference system: You are looking at the front panel.) Install the air filter only on the right side. the left side must stay without air filter.

1. Insert a flat-bladed screwdriver into the slot at the side panel.

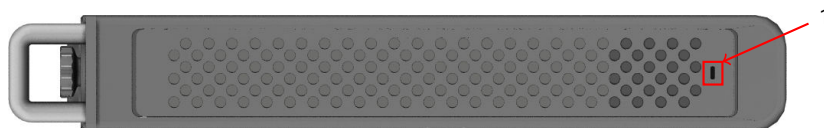

ASC-1: View on the right side panel; (1) slot

2. Slide the side panel towards the device's front.
3. First pull the side panel near the device's rear and then near the device's front to the side.
4. Replace the air filter with an equivalent one. Alternatively blow the air filter off.
5. Reassemble the air filter and the side panel in reverse order.

6.2.2. Replacing the battery

The battery mainly supplies the internal clock. The internal clock provides date and time for the LOG-files. If the internal clock is not running then you will not be able to correlate events on the time scale. But this may be necessary for troubleshooting.

Target audience and qualification

Experts

Have ready

- Battery; see table A.1 on page 90
- Non-conductive tweezers
- Flat-bladed screwdriver; width max. 5 mm

Safety precautions

- Disconnect the device from mains.

Procedure

TIP

In general the device is incorporated into a 19-inch rack. The battery can be accessed via the device's right side. For this purpose the connections at the device's rear have to be disconnected eventually and the device has to be pulled out from the 19-inch rack.

1. Insert a flat-bladed screwdriver into the slot at the side panel.

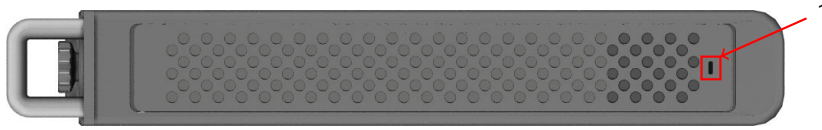

ASC-1: View on the right side panel; (1) slot

2. Slide the side panel towards the device's front.
3. Pull the side panel by the screwdriver from the device.
4. Remove the air filter.

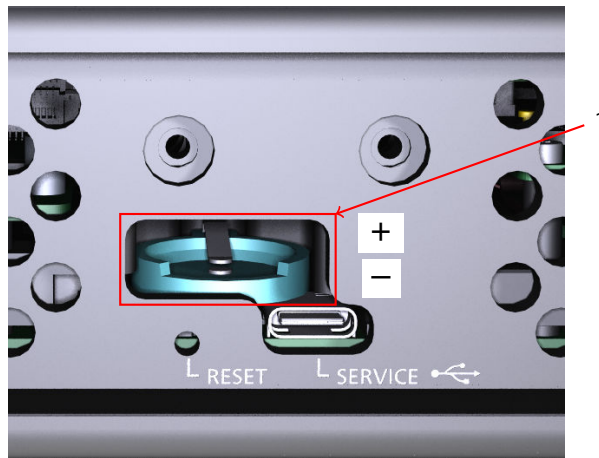

ASC-1: Battery holder (1)

5. Use non-conductive tweezers to insert the battery with the positive pole face up.
6. Reassemble the air filter and the side panel in reverse order.

6.3. Models ASC-2/-6 V41

6.3.1. Replacing the air filters

Target audience and qualification

Experts

Have ready

- Air filters; see table A.1 on page 90

Procedure

1. Stand facing the ASC rear.
2. Pull the right air filter cartridge, see the following figure, toward you and out from the device.

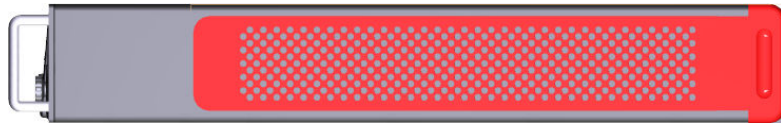

ASC-2 V41, ASC-6 V41: View on the right side panel; air filter cartridge marked red

3. Replace the air filter with an equivalent one. Alternatively blow the air filter off.
4. Push the air filter cartridge back into the device until it locks.
5. Repeat the procedure for the left air filter cartridge.
6. Some ASC models have air filters which are located behind the perforated front panel; see the following figure. Replace these too.

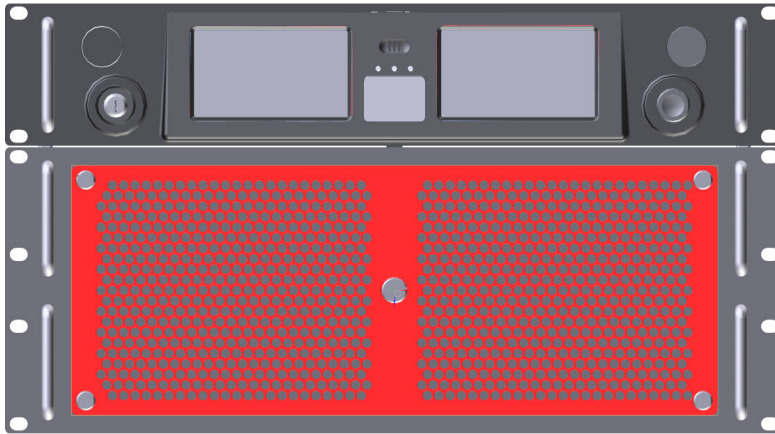

ASC-6 V41: View on the front side; perforated front panel marked red

6.3.2. Replacing the battery

The battery mainly supplies the internal clock. The internal clock provides date and time for the LOG-files. If the internal clock is not running then you will not be able to correlate events on the time scale. This may be necessary for troubleshooting.

Target audience and qualification

Experts

Have ready

- Battery; see table A.1 on page 90
- Non-conductive tweezers

Safety precautions

- Disconnect the device from mains.

Procedure

TIP

In general the device is incorporated into a 19-inch rack. The battery can be accessed via the device's side. For this purpose the connections at the device's rear have to be disconnected and the device has to be pulled out from the 19-inch rack. If the device contains a fiber laser then this procedure may be problematic due to the integral laser fiber.

1. Stand facing the ASC's aft.
2. Pull the right air filter cartridge toward you out from the ASC.

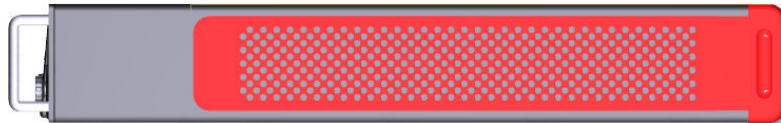

ASC-2 V41, ASC-6 V41: View on right side panel; air filter cartridge marked red

The battery can be accessed here:



ASC-2 V41, ASC-6 V41: Position of the battery access (marked red)

3. Remove the 2 screws (Torx, key size 6) and the battery cover which is marked red in the following figure.

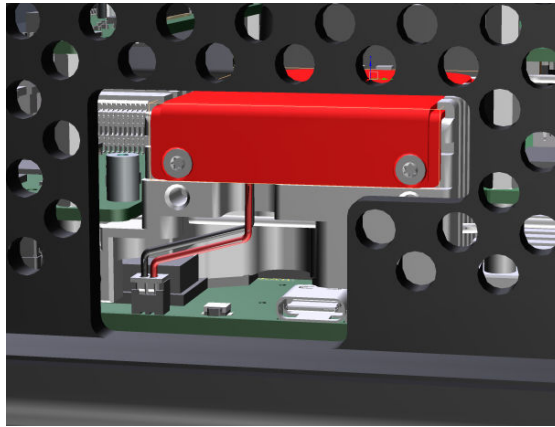

ASC-2 V41, ASC-6 V41: Battery cover (marked red)

4. Disconnect the battery module and remove it from the device.

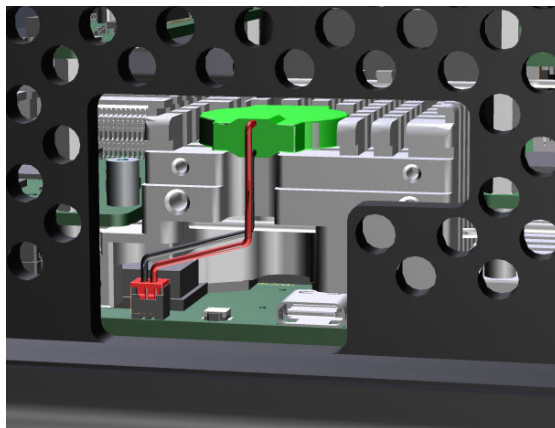

ASC-2 V41, ASC-6 V41: Plugged in battery module (marked green)

5. Replace the battery in the battery module by a new one.
6. Reassemble the device and plug it to mains again.
7. Set date and time via display and joystick; see section 5.4.2 on page 69.

6.4. Cleaning the fiber tips

Clean the fiber tips only when it is really necessary. Keep in mind that cleaning also degrades the quality of the optical surface.

Target audience and qualification

Experts

Safety precautions

- Switch off the laser unit (power supply), in particular the laser and moving parts.

Procedure

- Please consult the fiber manufacturer's and respectively laser manufacturer's documentation.

6.5. Installing firmware- or FPGA-update

Install an InScript firmware- or FPGA-update only, if you want to fix bugs or if you want to employ new functionality.

Find detailed instructions in [3], chapter *Controller Services*.

7. Decommissioning, returning and disposal

7.1. Decommissioning

Target audience and qualification

Experts

Requirements

- Decommission the controller only if you want to return it, were instructed to do so, or if you want to dispose of it.

Have ready

- Suitable screwdriver for the mounting screws
- Original protective covers for the laser beam exit, if a fiber laser is embedded

Safety precautions

- Switch off the laser unit, where the controller is incorporated. Switch off the laser device, power supply, cooling and particularly disable moving parts.

Procedure

1. Disconnect the power supply line from the controller.
2. Disconnect the remaining electrical lines from the controller.
3. Disconnect the laser fiber, if a fiber laser is embedded.

This procedure is described in the instruction manual of the respective scan head.



CAUTION

Heavy weight
Risk of injury

- Work together with a second person.

4. Dismount the controller from the laser unit.

7.2. Returning

This section describes how to prepare the controller if you want to return it.

Target audience and qualification

Laypersons, operators and experts

Requirements

- The controller has been decommissioned; see section 7.1 on page 87.

Have ready

- Original or an equivalent packaging
- Parcel tape

Procedure

1. Find the contact information for customer support and contact us; see page ii.
You will get instructions about how to proceed.
2. If you are instructed to return the controller then package it in its original or an equivalent packaging to prevent damage during transport.
As memory aid use the documentation that you may have taken during unpacking.
3. Arrange for return consignment.

7.3. Disposal

By ensuring the controller is disposed correctly, you will help prevent potential negative consequences for the environment and human health, which could otherwise be caused by inappropriate waste handling of the controller. The recycling of materials will help to conserve natural resources.

Target audience and qualification

Laypersons, operators and experts

Requirements

- The controller has been decommissioned; see section 7.1 on page 87.

Procedure

1. Remove the battery, for the ASC-1 see section 6.2.2 on page 80 or for the ASC-2/-6 V41 see section 6.3.2 on page 6.3.2 and dispose of the battery at a collecting point for batteries.
2. Do not treat the controller as household waste. Instead hand it over to the applicable collection point for the recycling of electrical and electronic equipment or hand it over to us; see section 7.2 on page 88.

For more detailed information about recycling of the controller, please contact your local city office, your disposal service, or the customer support; see page ii.

A. Appendix

A.1. Spare parts

If not mentioned otherwise, the given part numbers are the manufacturer's part numbers.

Table A.1.: List of spare parts

Figure	Description	Order number
[not available]	for ASC-1: 1× blue air filter foam mat, PPI 30, side, 172 × 27.6 × 6 mm ³	316-1128612-00
[not available]	for ASC-2 V41: 2× blue air filter foam mat, PPI 30, side, 356 × 62 × 12 mm ³	316-1131381-00
[not available]	for ASC-6 V41: 2× blue air filter foam mat, PPI 30, side, 356 × 62 × 12 mm ³ 2× blue air filter foam mat, PPI 30, front, 172 × 144 × 8 mm ³	316-1131381-00 316-1004874-00
[not available]	Lithium button cell battery, type CR1620	401-1014862-00
[not available]	Patch cable, SFTP, blue, 5 m	409-1007990-00
[not available]	Patch cable, 10 Gbit, Cat 5e, suitable for drag chains, 5 m	419-2001905-00
[not available]	Patch cable, 10 Gbit, Cat 5e, suitable for drag chains, 10 m	419-2001906-00

Figure	Description	Order number
[not available]	Patch cable, 10 Gbit, Cat 5e, suitable for drag chains, 15 m	419-2001920-00
[not available]	High-end-monitor cable, DVI – 5× BNC, generic, 5 m	419-1008175-00
[not available]	USA/CAN/JPN: Cold appliance power cord, 2 m	419-1012479-00
[not available]	EU/CN/RUS: Cold appliance power cord, 2 m	419-1008268-00

A.2. Further reading

- [1] *ARGES ControllerLib – User Manual.*
See the file ARG_ControllerLib_manual.pdf.
- [2] *InScript Firmware – User Manual.*
In the InScript software in the main menu, click **Manuals**.
- [3] *InScript Software – User Manual.*
In the InScript software in the main menu, click **Manuals**.
- [4] *WFI Base – Instruction Manual.*
See the file WFI_Base_<version>_manual_en.pdf.

A.3. Third party software licenses

This product is based in part on open source software the use of which is subject to the licenses that are listed further below. The source code of the software will be sent to you on request on a customary data carrier, the production costs will be asserted in return. Please send your inquiry to

<https://novantaphotonics.com/technical-support-request-form-header/>

Since it is free software, the developers of this software exclude the liability. Please note that the warranty for the hardware is not affected and is fully covered.

For further questions contact

<https://novantaphotonics.com/technical-support-request-form-header/>

PACKAGE, VERSION, LICENSE, LICENSE FILES, SOURCE ARCHIVE, SOURCE SITE

- alsa-lib, 1.1.5, LGPL-2.1+ (library), GPL-2.0+ (aserver), COPYING aserver/COPYING, alsa-lib-1.1.5.tar.bz2, ftp://ftp.alsa-project.org/pub/lib
- apr-util, 1.6.1, Apache-2.0, LICENSE, apr-util-1.6.1.tar.bz2, http://archive.apache.org/dist/apr
- apr, 1.6.3, Apache-2.0, LICENSE, apr-1.6.3.tar.bz2, http://archive.apache.org/dist/apr
- util-linux, 2.31.1, GPL-2.0+, BSD-4-Clause, LGPL-2.1+ (libblkid, libfdisk, libmount), BSD-3-Clause (libuuid) ISC (rfkill), README.licensing Documentation/licenses/COPYING.GPLv2 Documentation/licenses/COPYING.UCB Documentation/licenses/COPYING.LGPLv2.1 Documentation/licenses/COPYING.BSD-3 Documentation/licenses/COPYING.ISC, util-linux-2.31.1.tar.xz, <https://cdn.kernel.org/pub/linux/utils/util-linux/v2.31>
- busybox, 1.27.2, GPL-2.0, LICENSE, busybox-1.27.2.tar.bz2, http://www.busybox.net/downloads
- libtirpc, 1.0.2, BSD-3-Clause, COPYING, libtirpc-1.0.2.tar.bz2, http://downloads.sourceforge.net/project/libtirpc/libtirpc/1.0.2
- ncurses, 6.0, MIT with advertising clause, README, ncurses-6.0.tar.gz, http://ftpmirror.gnu.org/ncurses
- python3, 3.6.3, Python-2.0, others, LICENSE, Python-3.6.3.tar.xz, <https://python.org/ftp/python/3.6.3>
- bzip2, 1.0.6, bzip2 license, LICENSE, bzip2-1.0.6.tar.gz, http://sources.buildroot.net
- expat, 2.2.5, MIT, COPYING, expat-2.2.5.tar.bz2, http://downloads.sourceforge.net/project/expat/expat/2.2.5
- libffi, 3.2.1, MIT, LICENSE, libffi-3.2.1.tar.gz, ftp://sourceware.org/pub/libffi
- mpdecimal, 2.4.1, BSD-2-Clause, LICENSE.txt, mpdecimal-2.4.1.tar.gz, http://www.bytereef.org/software/mpdecimal/releases
- libopenssl, 1.0.2r, OpenSSL or SSLeay, LICENSE, openssl-1.0.2r.tar.gz, <https://www.openssl.org/source>
- zlib, 1.2.11, Zlib, README, zlib-1.2.11.tar.xz, http://www.zlib.net
- readline, 7.0, GPL-3.0+, COPYING, readline-7.0.tar.gz, http://ftpmirror.gnu.org/readline
- sqlite, 3250300, Public domain, tea/license.terms, sqlite-autoconf-3250300.tar.gz, <https://www.sqlite.org/2018>
- xz, 5.2.3, GPL-2.0+, GPL-3.0+, LGPL-2.1+, COPYING.GPLv2 COPYING.GPLv3 COPYING.LGPLv2.1, xz-5.2.3.tar.bz2, http://tukaani.org/xz
- bash, 4.4.12, GPL-3.0+, COPYING, bash-4.4.12.tar.gz, http://ftpmirror.gnu.org/bash
- bluez-tools, 171181b6ef6c94aefc828dc7fd8de136b9f97532, GPL-2.0+, COPYING, bluez-tools-171181b6ef6c94aefc828dc7fd8de136b9f97532.tar.gz, <https://github.com/khvak/bluez-tools/archive/171181b6ef6c94aefc828dc7fd8de136b9f97532>
- bluez_utils, 4.101, GPL-2.0+, LGPL-2.1+, COPYING COPYING.LIB, bluez-4.101.tar.xz, <https://cdn.kernel.org/pub/linux/bluetooth>
- check, 0.11.0, LGPL-2.1+, COPYING.LESSER, check-0.11.0.tar.gz, <https://github.com/libcheck/check/releases/download/0.11.0>
- dbus, 1.12.2, AFL-2.1 or GPL-2.0+ (library, tools), GPL-2.0+ (tools), COPYING, dbus-1.12.2.tar.gz, <https://dbus.freedesktop.org/releases/dbus>
- libglib2, 2.54.2, LGPL-2.1+, COPYING, glib-2.54.2.tar.xz, http://ftp.gnome.org/pub/gnome/sources/glib/2.54
- elfutils, 0.174, GPL-2.0+ or LGPL-3.0+ (library), GPL-3.0+ (programs), COPYING COPYING-GPLv2 COPYING-LGPLv3 COPYING, elfutils-0.174.tar.bz2, <https://sourceware.org/elfutils/ftp/0.174>
- pcre, 8.41, BSD-3-Clause, LICENCE, pcre-8.41.tar.bz2, <https://ftp.pcre.org/pub/pcre>
- libsndfile, 1.0.28, LGPL-2.1+, COPYING, libsndfile-1.0.28.tar.gz, http://www.mega-nerd.com/libsndfile/files
- libusb, 1.0.21, LGPL-2.1+, COPYING, libusb-1.0.21.tar.bz2, <https://github.com/libusb/libusb/releases/download/v1.0.21>
- eudev, 3.2.5, GPL-2.0+ (programs), LGPL-2.1+ (libraries), COPYING, eudev-3.2.5.tar.gz, http://dev.gentoo.org/~blueness/eudev
- kmod, 24, LGPL-2.1+ (library), GPL-2.0+ (tools), libkmod/COPYING COPYING, kmod-24.tar.xz, <https://cdn.kernel.org/pub/linux/utils/kernel/kmod>
- dbus-glib, 0.108, AFL-2.1 or GPL-2.0+, COPYING, dbus-glib-0.108.tar.gz, http://dbus.freedesktop.org/releases/dbus-glib
- cairo, 1.14.10, LGPL-2.1 or MPL-1.1 (library), COPYING COPYING-LGPL-2.1 COPYING-MPL-1.1, cairo-1.14.10.tar.xz, http://cairographics.org/releases
- fontconfig, 2.12.4, fontconfig license, COPYING, fontconfig-2.12.4.tar.bz2, http://fontconfig.org/release
- freetype, 2.9.1, Dual FTL/GPL-2.0+, docs/LICENSE.TXT docs/FTL.TXT docs/GPLv2.TXT, freetype-2.9.1.tar.bz2, <http://download.savannah.gnu.org/releases/freetype>
- libpng, 1.6.34, Libpng, LICENSE, libpng-1.6.34.tar.xz, http://downloads.sourceforge.net/project/libpng/libpng16/1.6.34
- pixman, 0.34.0, MIT, COPYING, pixman-0.34.0.tar.bz2, http://xorg.freedesktop.org/releases/individual/lib
- can-utils, c3305fdd515464153d20199db232b6124bc962c0, BSD-3-Clause or GPL-2.0, GPL-2.0+, , can-utils-c3305fdd515464153d20199db232b6124bc962c0.tar.gz, <https://github.com/linux-can/can-utils/archive/c3305fdd515464153d20199db232b6124bc962c0>
- coreutils, 8.27, GPL-3.0+, COPYING, coreutils-8.27.tar.xz, http://ftpmirror.gnu.org/coreutils
- cpuload, v0.3, GPL-2.0, COPYING, cpuload-v0.3.tar.gz, <https://github.com/kelvincheung/cpuload/archive/v0.3>
- dcrcon, 4.5, GPL, , dcrcon-4.5.tar.gz, http://www.jimpryor.net/linux/releases
- dialog, 1.3-20170509, LGPL-2.1, COPYING, dialog-1.3-20170509.tgz, ftp://ftp.invisible-island.net/dialog
- diffutils, 3.6, GPL-3.0+, COPYING, diffutils-3.6.tar.xz, http://ftpmirror.gnu.org/diffutils
- directfb, 1.7.7, LGPL-2.1+, COPYING, DirectFB-1.7.7.tar.gz, http://www.directfb.org/downloads/Core/DirectFB-1.7
- libjpeg, 9b, IJG, README, jpegsrc.v9b.tar.gz, http://www.ijg.org/files
- libsvg-cairo, 0.1.6, LGPL-2.1+, COPYING, libsvg-cairo-0.1.6.tar.gz, http://cairographics.org/snapshots
- libsvg, 0.1.4, LGPL-2.0+, COPYING, libsvg-0.1.4.tar.gz, http://cairographics.org/snapshots
- tslib, 1.15, GPL-2.0+ (programs), LGPL-2.1+ (libraries), COPYING, tslib-1.15.tar.xz, <https://github.com/kergoth/tslib/releases/download/1.15>

- dmalloc, 5.5.2, MIT-like, dmalloc.h.1, dmalloc-5.5.2.tgz, <http://dmalloc.com/releases>
- dos2unix, 7.4.0, BSD-2-Clause, COPYING.txt, dos2unix-7.4.0.tar.gz, <http://waterlan.home.xs4all.nl/dos2unix>
- dropbear, 2018.76, MIT, BSD-2-Clause-like, BSD-2-Clause, LICENSE, dropbear-2018.76.tar.bz2, <https://matt.ucc.asn.au/dropbear/releases>
- libtomcrypt, 1.18.1, WTFPL, LICENSE, crypt-1.18.1.tar.xz, <https://github.com/libtom/libtomcrypt/releases/download/v1.18.1>
- libtommath, 1.0.1, WTFPL, LICENSE, ltm-1.0.1.tar.xz, <https://github.com/libtom/libtommath/releases/download/v1.0.1>
- dt, v18.32, ISC-like, LICENSE, dt-source-v18.32.tar.gz, <http://pkgs.fedoraproject.org/repo/pkgs/dt/dt-source-v18.32.tar.gz/3054aeaaba047a1dbe90c2132a382ee2>
- e2fsprogs, 1.43.9, GPL-2.0, MIT-like with advertising clause (libss and libet), NOTICE lib/ss/mit-sipb-copyright.h lib/et/internal.h, e2fsprogs-1.43.9.tar.xz, <https://cdn.kernel.org/pub/linux/kernel/people/tytso/e2fsprogs/v1.43.9>
- eigen, 3.3.4, MPL2, BSD-3-Clause, LGPL-2.1, COPYING.MPL2 COPYING.BSD COPYING.LGPL COPYING.README, 3.3.4.tar.bz2, <https://bitbucket.org/eigen/eigen/get>
- ethtool, 4.13, GPL-2.0, COPYING, ethtool-4.13.tar.xz, <https://cdn.kernel.org/pub/software/network/ethtool>
- file, 5.36, BSD-2-Clause, BSD-4-Clause (one file), BSD-3-Clause (one file), COPYING src/mygetopt.h src/vasprintf.c, file-5.36.tar.gz, <ftp://ftp.astron.com/pub/file>
- findutils, 4.6.0, GPL-3.0+, COPYING, findutils-4.6.0.tar.gz, <http://ftpmirror.gnu.org/findutils>
- ftop, 1.0, GPL-3.0+, COPYING, ftop-1.0.tar.bz2, <https://sourceforge.net/projects/ftop/files/ftop/1.0>
- libsigsegv, 2.11, GPL-2.0+, COPYING, libsigsegv-2.11.tar.gz, <http://ftpmirror.gnu.org/libsigsegv>
- gdb, 7.11.1, GPL-2.0+, LGPL-2.0+, GPL-3.0+, LGPL-3.0+, COPYING COPYING.LIB COPYING3 COPYING3.LIB, gdb-7.11.1.tar.xz, <http://ftpmirror.gnu.org/gdb>
- git, 2.16.5, GPL-2.0, LGPL-2.1+, COPYING LGPL-2.1, git-2.16.5.tar.xz, <https://cdn.kernel.org/pub/software/scm/git>
- libcurl, 7.64.0, curl, COPYING, curl-7.64.0.tar.xz, <https://curl.haxx.se/download>
- gnutls, 3.5.19, LGPL-2.1+ (core library), GPL-3.0+ (gnutls-openssl library), doc/COPYING doc/COPYING.LESSER, gnutls-3.5.19.tar.xz, <https://www.gnupg.org/ftp/gcrypt/gnutls/v3.5>
- libtasn1, 4.13, GPL-3.0+ (tests, tools), LGPL-2.1+ (library), COPYING COPYING.LIB, libtasn1-4.13.tar.gz, <http://ftpmirror.gnu.org/libtasn1>
- libunistring, 0.9.10, LGPL-3.0+ or GPL-2.0, COPYING COPYING.LIB, libunistring-0.9.10.tar.xz, <http://ftpmirror.gnu.org/libunistring>
- nettle, 3.4, Dual GPL-2.0+/LGPL-3.0+, COPYING.LESSERv3 COPYINGv2, nettle-3.4.tar.gz, <http://www.lysator.liu.se/~nisse/archive>
- grep, 3.1, GPL-3.0+, COPYING, grep-3.1.tar.xz, <http://ftpmirror.gnu.org/grep>
- gzip, 1.8, GPL-3.0+, COPYING, gzip-1.8.tar.xz, <http://ftpmirror.gnu.org/gzip>
- haveged, 1.9.1, GPL-3.0+, COPYING, haveged-1.9.1.tar.gz, <http://www.issihosts.com/haveged>
- htop, 2.0.2, GPL-2.0, COPYING, htop-2.0.2.tar.gz, <http://hisham.hm/htop/releases/2.0.2>
- hwdata, v0.308, GPL-2.0+, BSD-3-Clause, XFree86 1.0, COPYING LICENSE, hwdata-v0.308.tar.gz, <https://github.com/vcrhonek/hwdata/archive/v0.308>
- i2c-tools, 4.0, GPL-2.0+, GPL-2.0 (py-smbus), COPYING, i2c-tools-4.0.tar.xz, <https://www.kernel.org/pub/software/utils/i2c-tools>
- iftop, 1.0pre4, GPL-2.0+, COPYING, iftop-1.0pre4.tar.gz, <http://www.ex-parrot.com/pdw/iftop/download>
- libpcap, 1.8.1, BSD-3-Clause, LICENSE, libpcap-1.8.1.tar.gz, <http://www.tcpdump.org/release>
- libnl, 3.4.0, LGPL-2.1+, COPYING, libnl-3.4.0.tar.gz, https://github.com/thom311/libnl/releases/download/libnl3_4_0
- iotop, 0.6, GPL-2.0+, COPYING, iotop-0.6.tar.gz, <http://guichaz.free.fr/iotop/files>
- iproute2, 4.14.1, GPL-2.0+, COPYING, iproute2-4.14.1.tar.xz, <https://cdn.kernel.org/pub/linux/utils/net/iproute2>
- iw, 4.9, ISC, COPYING, iw-4.9.tar.xz, <https://cdn.kernel.org/pub/software/network/iw>
- libarchive, 3.3.3, BSD-2-Clause, BSD-3-Clause, COPYING, libarchive-3.3.3.tar.gz, <http://www.libarchive.org/downloads>
- libxml2, 2.9.9, MIT, COPYING, libxml2-2.9.9.tar.gz, <ftp://xmlsoft.org/libxml2>
- libconfig, 1.5, LGPL-2.1+, COPYING.LIB, libconfig-1.5.tar.gz, <http://www.hyperrealm.com/libconfig>
- libevent, 2.1.8-stable, BSD-3-Clause, OpenBSD, LICENSE, libevent-2.1.8-stable.tar.gz, <https://github.com/libevent/libevent/releases/download/release-2.1.8-stable>
- libftdi, 0.20, unknown, libftdi-0.20.tar.gz, <http://www.intra2net.com/en/developer/libftdi/download>
- libusb-compat, 0.1.5, LGPL-2.1+, COPYING, libusb-compat-0.1.5.tar.bz2, <http://downloads.sourceforge.net/project/libusb/libusb-compat-0.1/libusb-compat-0.1.5>
- libftdi1, 1.4, LGPL-2.0 (libftdi1), GPL-2.0 with exception (ftdipp1), LICENSE COPYING.GPL COPYING.LIB, libftdi1-1.4.tar.bz2, <http://www.intra2net.com/en/developer/libftdi/download>
- libpciaccess, 0.14, MIT, COPYING, libpciaccess-0.14.tar.bz2, <http://xorg.freedesktop.org/releases/individual/lib>
- libpthread-stubs, 0.4, MIT, COPYING, libpthread-stubs-0.4.tar.bz2, <http://xcb.freedesktop.org/dist>
- libxslt, 1.1.32, MIT, COPYING, libxslt-1.1.32.tar.gz, <ftp://xmlsoft.org/libxslt>
- libyaml, 0.1.7, MIT, LICENSE, yaml-0.1.7.tar.gz, <http://pyyaml.org/download/libyaml>
- lighttpd, 1.4.52, BSD-3-Clause, COPYING, lighttpd-1.4.52.tar.xz, <http://download.lighttpd.net/lighttpd/releases-1.4.x>
- linux-firmware, 65b1c68c63f974d72610db38dfae49861117cae2, Proprietary, LICENSE.Marvell LICENSE.atheros_firmware LICENSE.broadcom_bcm43xx LICENSE.ibt_firmware LICENSE.iwlwifi_firmware LICENSE.ralink_firmware.txt LICENSE.ralink_a_mEDIATEK_company_firmware LICENSE.rtlwifi_firmware.txt LICENSE.ti-connectivity WHENCE, linux-firmware-65b1c68c63f974d72610db38dfae49861117cae2.tar.gz, <http://git.kernel.org/pub/scm/linux/kernel/git/firmware/linux-firmware.git>
- lm-sensors, 3.4.0, LGPL-2.1+ (libsensors), GPL-2.0+ (programs), COPYING.LGPL COPYING, lm-sensors_3.4.0.orig.tar.bz2, <http://snapshot.debian.org/archive/debian/20170208T211941Z/pool/main/l/lm-sensors>
- logrotate, 3.13.0, GPL-2.0+, COPYING, logrotate-3.13.0.tar.gz, <https://github.com/logrotate/logrotate/archive/3.13.0>
- popt, 1.16, MIT, COPYING, popt-1.16.tar.gz, <http://rpm5.org/files/popt>

- lsof, 4.89, lsof license, dialects/linux/dproto.h, lsof_4.89.tar.bz2, <http://www.mirrorservice.org/sites/lsof.itap.purdue.edu/pub/tools/unix/lsof>
- ltrace, c22d359433b333937ee3d803450dc41998115685, GPL-2.0, COPYING, ltrace-c22d359433b333937ee3d803450dc41998115685.tar.gz, [git://anonscm.debian.org/collab-maint/ltrace.git](https://anonscm.debian.org/collab-maint/ltrace.git)
- lua, 5.3.4, MIT, doc/readme.html, lua-5.3.4.tar.gz, <http://www.lua.org/ftp>
- memstat, 1.0, GPL, debian/copyright, memstat_1.0.tar.gz, <http://downloads.sourceforge.net/project/memstattool>
- memtester, 4.3.0, GPL-2.0, COPYING, memtester-4.3.0.tar.gz, <http://pyropus.ca/software/memtester/old-versions>
- memtool, 2016.10.0, GPL-2.0, COPYING, memtool-2016.10.0.tar.xz, <http://public.pengutronix.de/software/memtool>
- mtd, 2.0.2, GPL-2.0, COPYING, mtd-utils-2.0.2.tar.bz2, <ftp://ftp.infradead.org/pub/mtd-utils>
- nano, 2.9.0, GPL-3.0+, COPYING, nano-2.9.0.tar.xz, <https://www.nano-editor.org/dist/v2.9>
- netcat, 0.7.1, GPL-2.0+, COPYING, netcat-0.7.1.tar.gz, <http://downloads.sourceforge.net/project/netcat/netcat/0.7.1>
- netperf, 2.7.0, netperf license, COPYING, netperf-2.7.0.tar.bz2, <ftp://ftp.netperf.org/netperf>
- nfs-utils, 1.3.3, GPL-2.0+, COPYING, nfs-utils-1.3.3.tar.xz, <https://www.kernel.org/pub/linux/utils/nfs-utils/1.3.3>
- pciutils, 3.5.5, GPL-2.0+, COPYING, pciutils-3.5.5.tar.xz, <https://cdn.kernel.org/pub/software/utils/pciutils>
- psmisc, 23.1, GPL-2.0+, COPYING, psmisc-23.1.tar.xz, <http://downloads.sourceforge.net/project/psmisc/psmisc>
- python-argcomplete, 1.10.0, Apache-2.0, LICENSE.rst, argcomplete-1.10.0.tar.gz, <https://files.pythonhosted.org/packages/9c/c5/4009a381ba46f8424832b6fa9a6d8c79b2089a0170beb434280d293a5b5c>
- python-daemon, 2.1.1, Apache-2.0 (library), GPL-3.0+ (test, build), LICENSE.ASF-2 LICENSE.GPL-3, python-daemon-2.1.1.tar.gz, <https://pypi.python.org/packages/source/p/python-daemon>
- python-docutils, 0.14, Public Domain, BSD-2-Clause, GPL-3.0 (emacs mode), other, COPYING.txt, docutils-0.14.tar.gz, <https://pypi.python.org/packages/84/f4/5771e41fdf52aabebedecc9381d11dea0fa34e4759b4071244fa094804c>
- python-flup, 1.0.3.dev20161029, BSD-2-Clause, MIT, , flup-1.0.3.dev20161029.tar.gz, <https://pypi.python.org/packages/17/33/36768930a5ffe4f294ed3987c631bfd3fddb4f9e5e46bc8dc30fd731dbcd>
- python-future, 0.16.0, MIT, LICENSE.txt, future-0.16.0.tar.gz, <https://pypi.python.org/packages/00/2b/8d082ddfed935f3608cc61140df6dcfb0edeabc3ab52fb6c29ae3e81e85>
- python-lxml, 4.0.0, BSD-3-Clause, Others, LICENSES.txt doc/licenses/BSD.txt doc/licenses/elementtree.txt src/lxml/isoschematron/resources/mg/iso-schematron.mg, lxml-4.0.0.tgz, <http://lxml.de/files>
- python-numpy, 1.13.3, BSD-3-Clause, LICENSE.txt, numpy-1.13.3.tar.gz, <https://github.com/numpy/numpy/releases/download/v1.13.3>
- python-pip, 19.0.3, MIT, LGPL-2.1, BSD-3-Clause, BSD-3-Clause, MIT, LICENSE.txt src/pip/_vendor/msgpack/COPYING src/pip/_vendor/packaging/LICENSE src/pip/_vendor/certifi/LICENSE src/pip/_vendor/charset/LICENSE src/pip/_vendor/pytoml/LICENSE src/pip/_vendor/pep517/LICENSE src/pip/_vendor/idna/LICENSE.rst src/pip/_vendor/urllib3/LICENSE.txt src/pip/_vendor/webencodings/LICENSE src/pip/_vendor/lockfile/LICENSE src/pip/_vendor/pkg_resources/LICENSE src/pip/_vendor/cachecontrol/LICENSE.txt src/pip/_vendor/progress/LICENSE src/pip/_vendor/requests/LICENSE src/pip/_vendor/distlib/LICENSE.txt src/pip/_vendor/colorama/LICENSE.txt src/pip/_vendor/html5lib/LICENSE, pip-19.0.3.tar.gz, <https://files.pythonhosted.org/packages/36/fa/51ca4d57392e2f69397cd6e5af23da2a8d37884a605f9e3f2d3bfdc48397>
- python-pylibftdi, 0.15.0, MIT, LICENSE.txt, pylibftdi-0.15.0.tar.gz, <https://pypi.python.org/packages/e5/bb/d7a86dbd7685e3866ea75d21c6c726d01706df00aa5dc9051ce18ae65693>
- python-pysimpleguiweb, 0.39.0, unknown, , PySimpleGUIWeb-0.39.0.tar.gz, <https://files.pythonhosted.org/packages/9d/7c/1b9010df7f244121932962272e8d7df36bc14178dbc6b3629a787be14951>
- python-pyusb, 1.0.0, BSD-3-Clause, LICENSE, PyUSB-1.0.0.tar.gz, <https://pypi.python.org/packages/8a/19/66fb48a4905e472f5dfeda3a1bafac369fbf6d6fc5c5f55b780864962652d>
- python-pyyaml, 4.2b4, MIT, LICENSE, PyYAML-4.2b4.tar.gz, <https://files.pythonhosted.org/packages/a8/c6/a8d1555e795dbd0375c3c93b576ca13bbf139db51ea604afa19a2c35fc03>
- python-remi, 2020.8.6, unknown, , remi-2020.8.6.tar.gz, <https://files.pythonhosted.org/packages/d1/74/e2a1f5df4e57170369b221017c954ce9002901b9cc136365de0cf300e72a>
- python-setuptools, v38.4.0, MIT, LICENSE, python-setuptools-v38.4.0.tar.gz, <https://github.com/pypa/setuptools/archive/v38.4.0>
- qextserialport, ada321a9ee463f628e7b781b8ed00ff219152158, MIT, LICENSE.md, qextserialport-ada321a9ee463f628e7b781b8ed00ff219152158.tar.gz, <https://github.com/qextserialport/qextserialport/archive/ada321a9ee463f628e7b781b8ed00ff219152158>
- qt, 4.8.7, LGPL-2.1 with exceptions or GPL-3.0, Public Domain (Micro/Fixed font), Adobe Helvetica license (Helvetica/Japanese fonts), Freeware (Unifont font), Bitstream license (DejaVu/Vera TrueType fonts), LICENSE.LGPL LGPL_EXCEPTION.txt LICENSE.GPL3 src/3rdparty/fonts/ COPYING.Helvetica src/3rdparty/fonts/COPYRIGHT.Unifont src/3rdparty/fonts/COPYRIGHT.DejaVu src/3rdparty/fonts/README.DejaVu src/3rdparty/fonts/COPYRIGHT.Vera, qt-everywhere-opensource-src-4.8.7.tar.gz, <http://download.qt.io/archive/qt/4.8/4.8.7>
- qjson, 0.9.0, LGPL-2.1, COPYING.lib, qjson-0.9.0.tar.gz, <https://github.com/flavio/qjson/archive/0.9.0>
- qwt, 6.1.3, LGPL-2.1 with exceptions, COPYING, qwt-6.1.3.tar.bz2, <http://downloads.sourceforge.net/project/qwt/qwt/6.1.3>
- ramsmmp, 3.5.0, Alasir License, LICENSE, ramsmmp-3.5.0.tar.gz, <http://www.alasir.com/software/ramsmmp>
- rpcbind, 0.2.3, BSD-3-Clause, COPYING, rpcbind-0.2.3.tar.bz2, <http://downloads.sourceforge.net/project/rpcbind/rpcbind/0.2.3>
- samba4, 4.8.8, GPL-3.0+, COPYING, samba-4.8.8.tar.gz, <https://download.samba.org/pub/samba/stable>
- screen, 4.6.2, GPL-3.0+, COPYING, screen-4.6.2.tar.gz, <http://ftpmirror.gnu.org/screen>
- sed, 4.4, GPL-3.0, COPYING, sed-4.4.tar.xz, <http://ftpmirror.gnu.org/sed>
- spi-tools, 0.8.1, GPL-2.0, LICENSE, spi-tools-0.8.1.tar.gz, <https://github.com/cpb-/spi-tools/archive/0.8.1>
- sshpass, 1.06, GPL-2.0+, COPYING, sshpass-1.06.tar.gz, <http://downloads.sourceforge.net/project/sshpass/sshpass/1.06>
- strace, 4.20, BSD-3-Clause, COPYING, strace-4.20.tar.xz, <http://downloads.sourceforge.net/project/strace/strace/4.20>

- stress, 1.0.4, GPL-2.0+, COPYING, stress-1.0.4.tar.gz, <http://people.seas.harvard.edu/~apw/stress>
- subversion, 1.9.10, Apache-2.0, LICENSE, subversion-1.9.10.tar.bz2, <http://mirror.catn.com/pub/apache/subversion>
- sudo, 1.8.21p2, ISC, BSD-3-Clause, doc/LICENSE, sudo-1.8.21p2.tar.gz, <https://www.sudo.ws/sudo/dist>
- swupdate, 2018.11, GPL-2.0+ with OpenSSL exception, LGPL-2.1+, MIT, Licenses/Exceptions Licenses/gpl-2.0.txt Licenses/lgpl-2.1.txt Licenses/mit.txt, swupdate-2018.11.tar.gz, <https://github.com/sbabic/swupdate/archive/2018.11>
- libsoem, 0a67e6bf94df5ca7d61e624b56a6ad47db2fe020, unknown, , libsoem-0a67e6bf94df5ca7d61e624b56a6ad47db2fe020.tar.gz, <https://github.com/OpenEtherCATsociety/SOEM/archive/0a67e6bf94df5ca7d61e624b56a6ad47db2fe020>
- sysvinit, 2.88, GPL-2.0+, COPYING, sysvinit_2.88dsf.orig.tar.gz, <http://snapshot.debian.org/archive/debian/20141023T043132Z/pool/main/s/sysvinit>
- tar, 1.29, GPL-3.0+, COPYING, tar-1.29.tar.xz, <http://ftpmirror.gnu.org/tar>
- tcpdump, 4.9.2, BSD-3-Clause, LICENSE, tcpdump-4.9.2.tar.gz, <http://www.tcpdump.org/release>
- tiff, 4.0.8, tiff license, COPYRIGHT, tiff-4.0.8.tar.gz, <http://download.osgeo.org/libtiff>
- time, 1.8, GPL-3.0+, COPYING, time-1.8.tar.gz, <http://ftpmirror.gnu.org/time>
- tmux, 2.6, ISC, README, tmux-2.6.tar.gz, <https://github.com/tmux/tmux/releases/download/2.6>
- valgrind, 3.12.0, GPL-2.0, GFDL-1.2, COPYING COPYING.DOCS, valgrind-3.12.0.tar.bz2, <http://valgrind.org/downloads>
- vim, v8.0.0329, Charityware, README.txt, vim-v8.0.0329.tar.gz, <https://github.com/vim/vim/archive/v8.0.0329>
- wget, 1.19.5, GPL-3.0+, COPYING, wget-1.19.5.tar.lz, <http://ftpmirror.gnu.org/wget>
- which, 2.21, GPL-3.0+, COPYING, which-2.21.tar.gz, <http://ftpmirror.gnu.org/which>
- wireless_tools, 30.pre9, GPL-2.0, COPYING, wireless_tools.30.pre9.tar.gz, <https://hewlettpackard.github.io/wireless-tools>
- wpa_supplicant, 2.6, BSD-3-Clause, README, wpa_supplicant-2.6.tar.gz, <http://w1.fi/releases>
- xerces, 3.1.4, Apache-2.0, LICENSE, xerces-c-3.1.4.tar.xz, <http://archive.apache.org/dist/xerces/c/3/sources>
- xutil_util-macros, 1.19.1, MIT, COPYING, util-macros-1.19.1.tar.bz2, <http://xorg.freedesktop.org/releases/individual/util>
- uboot, 20050801_ascv4x_devrelease, GPL-2.0+, Licenses/gpl-2.0.txt, uboot-20050801_ascv4x_devrelease.tar.gz, thallo:/adev/repo/extgit/asc_v4x_u-boot.git
- buildroot, 2018.02.12-04433-ga45d146-21080902, GPL-2.0+, COPYING, not saved, not saved
- lzip, 1.19, GPL-2.0+, COPYING, lzip-1.19.tar.gz, <http://download.savannah.gnu.org/releases/lzip>
- gcc-final, 6.4.0, unknown, , gcc-6.4.0.tar.xz, <http://ftpmirror.gnu.org/gcc/gcc-6.4.0>
- gawk, 4.1.4, GPL-3.0+, COPYING, gawk-4.1.4.tar.xz, <http://ftpmirror.gnu.org/gawk>
- gcc-initial, 6.4.0, unknown, , gcc-6.4.0.tar.xz, <http://ftpmirror.gnu.org/gcc/gcc-6.4.0>
- binutils, 2.29.1, GPL-3.0+, libiberty LGPL-2.1+, COPYING3 COPYING.LIB, binutils-2.29.1.tar.xz, <http://ftpmirror.gnu.org/binutils>
- gmp, 6.1.2, LGPL-3.0+ or GPL-2.0+, COPYING.LESSERv3 COPYINGv2, gmp-6.1.2.tar.xz, <http://ftpmirror.gnu.org/gmp>
- m4, 1.4.18, GPL-3.0+, COPYING, m4-1.4.18.tar.xz, <http://ftpmirror.gnu.org/m4>
- mpc, 1.0.3, LGPL-3.0+, COPYING.LESSER, mpc-1.0.3.tar.gz, <http://ftpmirror.gnu.org/mpc>
- mpfr, 3.1.6, LGPL-3.0+, COPYING.LESSER, mpfr-3.1.6.tar.xz, <http://www.mpfr.org/mpfr-3.1.6>
- patchelf, 0.9, GPL-3.0+, COPYING, patchelf-0.9.tar.bz2, <https://nixos.org/releases/patchelf/patchelf-0.9>
- uboot-tools, 2018.01, GPL-2.0+, Licenses/gpl-2.0.txt, u-boot-2018.01.tar.bz2, <ftp://ftp.denx.de/pub/u-boot>
- glibc, glibc-2.26-193-ga0bc5dd3bed4b04814047265b3bcead7ab973b87, GPL-2.0+ (programs), LGPL-2.1+, BSD-3-Clause, MIT (library), /COPYING /COPYING.LIB /LICENSES, glibc-glibc-2.26-193-ga0bc5dd3bed4b04814047265b3bcead7ab973b87.tar.gz, <https://github.com/bminor/glibc/archive/glibc-2.26-193-ga0bc5dd3bed4b04814047265b3bcead7ab973b87>
- linux-headers, 21072801_ascv4x_devrelease, GPL-2.0, COPYING, linux-21072801_ascv4x_devrelease.tar.gz, thallo:/adev/repo/extgit/asc_v4x_kernel.git
- dash, 0.5.9.1, BSD-3-Clause, GPL-2.0+ (mksignames.c), COPYING, dash-0.5.9.1.tar.gz, <http://gondor.apana.org.au/~herbert/dash/files>



Novanta Corporation

125 Middlesex Turnpike
Bedford, MA 01730, USA

Phone: +1-781-266-5800

Email: Photonics@Novanta.com

Website: www.NovantaPhotonics.com

ARGES System Controller, ARGNET Series,
Model ASC-1, ASC-2 V41, ASC-6 V41

User Manual

2024-02-05

© 2024, Novanta Corporation. All rights reserved.